

Reclassification of the New World antlion genera formerly included in the tribe Brachynemurini (Neuroptera: Myrmeleontidae)

Lionel A. Stange

Florida State Collection of Arthropods
Department of Agriculture & Consumer Services
P.O. Box 147100
Gainesville, FL, 32614-7100 U.S.A.

Abstract

A cladistic analysis of the New World tribe Brachynemurini has resulted in several new taxonomic designations. The tribe is divided into 3 tribes, 2 of which are newly described. The Brachynemurini s.s. now contains 12 genera of which *Argentoleon*, *Atricholeon*, *Mexoleon* and *Venezueleon* are newly described. The Gnopholeontini (NEW TRIBE) includes 4 North American genera whereas the Lemolemini (NEW TRIBE) contains 6 South American genera of which *Ecualleon* and *Galapagoleon* are newly described. Descriptions of genera in the 3 tribes, based on adults and known larvae, are given. Keys to the genera in each tribe are provided, as well as a key to the tribes of Myrmeleontidae.

KEY WORDS: Neuroptera, Myrmeleontidae, New World, keys, cladistics, phylogeny, classification.

Introduction

Since the revision of the North American Brachynemurini by Stange (1970), additional adult and larval characters (Stange & Miller, 1990) have been found which have led to the present reclassification of New World brachynemurine genera into three tribes. Twenty-three genera are hereby recognized. Representative larvae of nineteen of these genera are known. A cladistic analysis of these genera has led to significant changes in their classification. Two groups of genera formerly placed in the Brachynemurini are given tribal status (Gnopholeontini and Lemolemini); the remaining genera are maintained as the Brachynemurini. The Gnopholeontini are restricted to the Sonoran Region; they are defined by the autapomorphy of the close approximation of the larval mandibles. The Lemolemini are most diverse in Chile; they are defined by the autapomorphies of the development of specialized setae on the median area of the larval abdominal tergites and the lack of digging setae on the female ectoproct. Both the Gnopholeontini and Lemolemini have highly modified posterior gonopophyses of the female terminalia. The more restricted Brachynemurini are defined by the fol-

lowing autapomorphies: 1) postventral lobe of male ectoproct; 2) a narrow gonapophyseal plate; and 3) a short distal tooth of the larval mandible, which is not parallel with other teeth. Since larval traits are here considered to be very important for the inference of phylogenetic relationships, two analyses were made: one of all genera and the other using only genera in which the larvae are known.

Higher level relationships within the Myrmeleontoidea

Relationships among higher taxa within the Myrmeleontoidea have not previously been investigated cladistically. MacLeod (1970) has indicated several autapomorphies of the superfamily based on the larval head. The apomorphic larval head characters unite the Psychopsidae, Nymphidae, Nemopteridae, Ascalaphidae and Myrmeleontidae into a group. Mansell (1992) has provided the most recent discussion of the relationships within the Myrmeleontoidea indicating apomorphies for the various families and providing a phylogenetic tree. Oswald (1993) has completed a cladistic analysis of the Psychopsidae, a family hypothesized as the sister-group of the rest of the Myrmeleontoidea

(Withycombe, 1925; Henry, 1978). The following analysis of the tribes of the Myrmeleontidae uses these four families as outgroups to help determine outgroups for the generic analysis.

The Psychopsidae (26 extant species in 5 genera, found in Africa, Australia and the Orient) and Nymphidae (about 25 species in 8 genera, restricted to Australia and New Guinea) are small relict families. The Nemopteridae and Ascalaphidae are much larger and more diverse. Since many of the characters used in the tribal analysis of the Myrmeleontidae vary considerably among the two subfamilies of Nemopteridae, both subfamilies were entered independently for a clearer resolution of the relationships. The Ascalaphidae appears to be even more diverse with at least 3 subfamilies and many tribes. However, the classification of the Ascalaphidae is so poorly established that the characters are entered for the family as a whole.

The tribal classification of the world Myrmeleontidae is based on Markl (1956) with modifications indicated by Stange & Miller (1985; 1990). Since larvae are known for all the major groups, it was decided to utilize both larval and adult characters in the analysis. The only tribes of Myrmeleontidae unknown in the larval stage are the Pseudimarini (1 rare species) and Maulini (about 5 species in 2 genera). Although the larvae in general reinforce the tribal classification, one problem in using larvae was recognized. The larvae of the Dimarini are highly diverse (Stange, 1989) so that 2 of the 3 constituent genera were entered rather than the tribe as a whole. Preliminary analysis led to the belief that three distinct groups were present in the Brachynemurini. To attempt to substantiate a separate treatment of these 3 groups, they were entered independently in the analysis. The following informative characters were used. The data matrix is given in Appendix 1.

List of myrmeleontid tribal apomorphies

(HEAD)

1. Mouthparts - (0) short mouthparts; (1) head prolonged with long mouthparts

Comments: The elongated head and mouthparts is associated with pollen feeding in the Nemopteridae.

2. Antennal shape - (0) filiform; (1) clavate (Fig. 36); (2) Clubbed

Comments: The shape of the antennae is fairly consistent but there are a few exceptions. Filiform-like antennae are found both in the Ascalaphidae (*Tmesibasis*) and Myrmeleontidae (*Anteonoleon*,

Lachlathetes) but these exceptions are considered secondary modifications.

3. Labial palp, sensory area - (0) palpimacula present but without pit; (1) oval-shaped pit; (2) elongate, slit-shaped pit

Comments: The apomorphic condition (2) is found in the Acanthaclisini, Dimarini, Palparidiini and some genera of the Palparini. Whether the latter tribe should be considered plesiomorphic or apomorphic in regards to this character is not completely clear but results scoring this character both ways do not change the results except for a minor node difference. The outgroups have small palpimacula and the evolution of enlarged palpimacula seems to be found only in the Myrmeleontidae. The Nemopteridae may have lost the pit-like palpimacula when they adapted to pollen feeding.

(THORAX)

4. Pronotum - (0) wider than long; (1) as long as wide or longer

Comments: Mansell (1992b) considers without much justification the broad pronotum as an autapomorphy of the Palparinae. It is treated here as plesiomorphic mainly because it is found in the Psychopsidae which is considered to be the sister group of the rest of the Myrmeleontoidea. The polarity is subjective fundamentally but scored either way would not change the cladogram.

5. Pronotal articulation (taken from Adams, 1958); (0) pronotum articulates with mesothorax (Psychopsidae; Nymphidae); (1) pronotum articulates with mesothoracic spiracle; (2) pronotum articulates with greatly enlarged mesothoracic spiracle

6. Pretarsal arolium - (0) present; (1) absent

Comments: The presence of an arolium is considered the plesiomorphic condition in the Myrmeleontoidea. There is an evident arolium in Psychopsidae whereas in the Nymphidae the arolium is deeply bifid, forming two pulvilliform lobes. In the Ascalaphidae and Myrmeleontidae the auxiliae are fused forming a bristly median lobe co-adapted to a strong unguitactor plate which strengthens the flexing mechanism of the claws. The arolium is completely absent in these families.

7. Femoral sense hair - (0) absent; (1) present on proleg and mesoleg (Fig. 9)

Comments: The femoral sense hair is an autapomorphy of the subfamily Myrmeleontinae. In a few genera (i.e., *Atricholeon*, *Venezuleon*) the hair has been secondarily lost as evidenced by the strong reduction of all leg setae in these genera. In the Acanthaclisini there is also a femoral sense hair (sometimes two) on the metaleg.

8. Hindwing - (0) similar to forewing; (1) greatly elongated

(WING VENATION)

9. Forewing, origin vein CuP - (0) at or before basal crossvein; (1) distad of M-Cu or CuP obsolete; (2) M-Cu obsolete

Comments: The apomorphic condition is found in Gnopholeontini, Lemolemini and Brachynemurini. Elsewhere, the apomorphic condition has been observed only in the South African genus *Nannoleon* and Maulini and in some Dendroleontini.

10. Forewing, condition of vein 1A - (0) Free course from base to hind margin (see Markl 1954: Fig. 62); (1) united with CuP near base (Figs. 10-11)

Comments: The genus *Palparidius* is variable in this character.

11. Hindwing, origin of radial sector - (0) near wing base, well before origin of medial fork; (1) originates distal to medial fork (Fig. 15); (2) greatly reduced

Comments: This is a progressive character where the origin of the radial sector has apparently migrated distally according to Tillyard (1915). Usually there are only 1 or 2 presectoral crossveins in the plesiomorphic condition but some palparine genera have more due to the extensive crossveins found in wing areas.

12. Both wings, hypostigmatic cell - (0) absent; (1) Short, less than 3x longer than high; (2) elongate, more than 5x longer than high (Fig. 15)

Comments: The shape of the hypostigmatic cell appears to be a very constant character in the Myrmeleontoidea. However, there are a few genera of Myrmeleontidae (*Maracandula*, *Nuglerus*) where the hypostigmatic cell is short as in the Ascalaphidae. This is probably parallel evolution since these genera in other characters appear to be relatively apomorphic in their tribes. The short and long hypostigmatic cell conditions are entered as non-additive since it is not clear whether the ascalaphid type or myrmeleonid type represents the apomorphic condition.

13. Both wings, subcostal area - (0) with at least basal crossvein; (1) without crossveins (Fig. 15)

Comments: Oswald (1993) tentatively asserts that the presence of the basal subcostal crossvein is plesiomorphic in Psychopsidae and the proliferation of additional crossveins as apomorphic. This may be true in the Nymphidae as well since New (1981) clearly shows some genera of Nymphidae with only 1 basal crossvein and others with many crossveins. The basal crossvein is absent in the Ascalaphidae and Myrmeleontidae which is taken as a synapomorphy of these two families. If the development of distal crossveins in the

Myrmeleontidae is a derived state, then the distal crossveins in *Pseudimares iris* Kimmins may represent a derived condition rather than a vestigial condition.

14. *Pilula axillaris* (#12) - (0) absent; (1) present

Comments: The *pilula axillaris* or Eltringham's organ is found only in the Myrmeleontidae and is an autapomorphy of the family. The absence of the structure in several groups (especially Nemoleontini) is considered a reversal.

(ABDOMEN)

15. First abdominal spiracle (data taken from Adams, 1958) - (0) connected to mesepimeron; (1) incorporated with the metepimeron

Comments: The migration of the first abdominal spiracle onto the metepimeron appears associated with the diminution of the first tergite. Probably this relocation of the spiracle improves the air supply to the flight muscles.

16. Female terminalia, posterior gonapophysis (#16) - (0) absent; (1) plate-like; (2) elongate, digitiform (Figs. 17-22); (3) inflated or greatly enlarged (Figs. 23-27, 30-32)

Comments: There is confusion about terminology of the gonapophyses. Tjeder (1977) decided to use other terms. However, I consider that the proper names are still to be resolved and use my terminology (Stange, 1970) here. The posterior gonapophysis appears to have evolved from an inconspicuous swollen plate in the Ascalaphidae and Palparinae to huge structures in *Neulatus* (Fig. 27). Miller (1991) has suggested that the inflated posterior gonapophyses function as egg handlers whereas the digitiform gonapophyses are used for soil testing.

17. Female terminalia, gonapophyseal plate - (0) absent; (1) narrower than width of posterior gonapophysis; (2) wider than width of posterior gonapophysis

Comments: The gonapophyseal plate is an asetose sclerite which forms part of the floor of the genital chamber and apparently articulates with the posterior gonapophyses. Usually the larger the posterior gonapophysis, the larger the gonapophyseal plate although with some exceptions (*Acanthaclisini*; *Nemoleontini*). This might be a synapomorphy of the Myrmeleontinae except it appears to be absent in the Myrmeleontini (a secondary loss?). Some parallel evolution in the reduction of this plate is seen in the Brachynemurini. It can be moderately large (*Dejuna*) to very small (*Scotoleon*) and some Dendroleontini such as *Glenoleon* which is variable, but *Glenoleon* is probably paraphyletic.

18. Lateral gonapophysis, chaetotaxy (Figs. 17-32) - (0) digging setae weakly to moderately developed, never longer than gonapophyseal width (Figs. 17-27); (1) digging setae large, down curved, longer than gonapophyseal width (Figs. 28,29).

19. Male ectoproct (#20) - (0) without elongate postventral lobe (Figs. 50, 51, 53); (1) with elongate postventral lobe (Figs. 47, 49, 55).

Comments: The Ascalaphidae is about as variable as the Myrmeleontidae in this character so that the polarity can not be established for the family as a whole. Some variation occurs in the Brachynemurini; Myrmecaelurini and Nemoleontini, but the ground plan is considered apomorphic for the Brachynemurini and plesiomorphic for the other two tribes.

(LARVAL CHARACTERS)

Larval characters of the Psychopsidae and Nymphidae are discussed by MacLeod, 1970; New 1982, 1983, 1989.

20. Mandibular distance - (0) widely separated; (1) closely approximated

Comments: The approximation of the mandibular bases is found only in the Gnopholeontini among the Myrmeleontidae. The most extreme case is *Gnopholeon barberi* (Fig. 69). Elsewhere the closer approximation of the mandible is found only in the Ascalaphidae. This is evidently a derived condition and is probably associated with sessile larvae in which the trap structure is more advantageous.

21. Mandible, dentition - (0) without teeth; (1) with 2-3 parallel teeth (Figs. 64-70); (2) distal tooth at different angle than middle tooth (Fig. 63).

Comments: The development of mandibular teeth is clearly synapomorphic for Nymphidae, Ascalaphidae and Myrmeleontidae. All other families of Neuroptera including the Myrmeleontoid families Nemopteridae and Psychopsidae lack true mandibular teeth. Mandibular teeth are apparently derived from enlarged setal bases (Baba, 1954) and, based on known evidence, the development of at least 3 teeth appears to be the next step without intermediate stages of having 1 or 2 teeth. All known ascalaphid larvae and the great majority of ant-lion larvae have 3 teeth. Some extant nymphid larvae have only 1 large tooth, but this is probably due to reduction since a fossil nymphid (*Pronymphes*) has 3 parallel teeth and at least 1 undescribed extant species has several teeth. Related to larval predation strategies, the mandible has become longer in some groups, shorter in others. Probably there has been repeated lengthening and shortening of mandibles as the different types appear in different evolutionary lines. The lengthening of the mandible often is accompanied by having the teeth situated more distally, or in a few palparine genera (*Golafrus*;

Palpares) additional teeth (4 to 6) are developed. The shortening of the mandible has led to a reduction of teeth in only a few cases. Two teeth are found in *Glenurus* (Nemoleontini), *Centroclisis* (Acanthaclisini) and *Millerleon* (Dimarini). The latter genus is the most enigmatic since the short teeth still show remnants of the seta. Only 1 tooth is present in *Paranthaclisis* (Acanthaclisini). Usually, the teeth are parallel with an increasing length distally although several groups have the middle tooth the longest. These are all probably derived conditions and are not the focus of the present analysis. In the present analysis, the primary apomorphy is the modification of the distal tooth which is much shorter than the middle tooth but, more important, situated at a different angle. This apomorphy is found in Brachynemurini, Myrmecaelurini, and Nesoleontini.

22. Labial palpus, length - (0) elongate, longer than basal width of mandible; (1) shorter than basal width of mandible

23. Ocular tubercles - (0) absent; (1) present

24. Mesothoracic spiracle - (0) sessile; (1) pedunculate

25. Hindtarsus and tibia - (0) articulated; (1) fused

26. Hind pretarsal claws - (0) not larger than fore pretarsal claws; (1) much larger than fore pretarsal claws

Comments: The enlarged hind pretarsal claws are evidently an adaptation for burrowing backwards into the sand. The only known exception in the Myrmeleontidae is *Gnopholeon barberi*. The reduction in the size of the hind pretarsal claws is probably a reversal in this species, which does not burrow in the sand and is ecologically similar to the Ascalaphidae. It is also possible that the Ascalaphidae are derived from the Myrmeleontidae, and have secondarily lost the enlarged hind pretarsal claws as an adaptation to living on plants. In some of the Nemopterinae which burrow into the sand head-first, the anterior pretarsal claws are enlarged.

27. Abdominal fossoria - (0) absent; (1) present

Comments: The fossoria are enlarged digging setae on sternite IX and sometimes found only on the third instar larva.

28. Abdominal sternite VIII - (0) without submedial teeth; (1) with submedial teeth (Fig. 16).

Comments: The development of submedial teeth may be a synapomorphy of the Ascalaphidae and Myrmeleontidae

The characters and taxa were analyzed using the Hennig86 cladistics program (version 1.5) of Farris (1989). Using the ie option, 6 equally parsimonious cladograms were found (length = 71; consistency index (ci) = 0.53; retention index (ri) = 0.70). The successive approximations character weighting feature (Farris 1969; Carpenter, 1988) resulted in 2 cladograms (ci = 0.83; ri = 0.92). Character weights are given in Appendix 3. The cladograms are shown in Figs. 1-2.

The suite of characters used in this analysis support the recognition of five families. As can be appreciated from the cladograms, the Ascalaphidae is so close that it could be considered as a subfamily of Myrmeleontidae. All the autapomorphies for the Ascalaphidae appear somewhere in the Myrmeleontidae. However, two other apomorphies exist which may strengthen the case for family recognition of the Ascalaphidae. The antennae are significantly longer than in the Myrmeleontidae except for the bizarre genus *Albardia*. The caudate head of the larva may be apomorphic for the Ascalaphidae.

The 2 weighted cladograms are the same except for the placement of the Nemoleontini. According to current classification, the Palparini, Palparidiini, and Dimarini (*Dimares*, *Millerleon*), together with the Pseudimarini (not included in the analysis because the larval stage unknown) constitute the subfamily Palparinae. The results of the present analysis indicate that the subfamily Palparinae in the traditional sense is paraphyletic. The Stilbopteryginae (considered currently as a separate subfamily) could also be a constituent tribe of the Palparinae if one wishes to recognize paraphyletic taxa. Another treatment supported by this cladistic analysis is to recognize three subfamilies; the Palparinae (Palparidiini and Palparini), the Stilbopteryginae, and the Dimarinae with the Pseudimarini as *incertae sedis*, but possibly in the Dimarinae. However, more character analysis of the Stilbopteryginae and associated groups is needed before such a change is recommended. The Stilbopteryginae have always been a controversial group, sometimes classified with the Ascalaphidae based on the clubbed antenna and short hypostigmatic cells which are key characters of the Ascalaphidae. It has also been treated as a separate family and, more recently (New 1982), as a subfamily of the Myrmeleontidae. New's concept is supported by this analysis.

Although the genera *Dimares* and *Millerleon* were entered independently in the analysis due to

the extreme differences in the larvae of the 2 genera (loss of the fossoria & submedial teeth in *Millerleon*), the analysis supports the two genera forming a monophyletic group.

The monophyly of the Nemoleontini appears to be weakly supported only by the reversal of character #14 (secondary loss of the pilula axillaris). This apomorphy is also found in the Nesoleontini and in the Brachynemurini (*Scotoleon*). Since the tribe forms a trichotomy with the groups treated here in one cladogram and as a sister group to the Brachynemurini + (Lemolemini + (Gnopholeontini + Dendroleontini)) in the other cladogram, it was decided to use the Nemoleontini as one of the outgroups.

Relationships within the Gnopholeontini, Lemolemini, and Brachynemurini

In earlier papers on the classification of the Brachynemurini (Stange & Miller 1985; 1992), the Brachynemurini was reduced to a subtribe of the Myrmecaelurini. This was based on the remarkable convergence in the dentition of the larval mandible. However, the present analysis suggests a closer relationship of the Myrmecaelurini to the Acanthaclisini based on female terminalia (character #18). The relationship of the Acanthaclisini with the Myrmecaelurini + Nesoleontini is supported by another apomorphy not used in the analysis, the presence of abdominal hair pencils. Hair pencils are found in all groups of the Acanthaclisini. Elsewhere, they are found only in some genera of the Myrmecaelurini.

The present tribal analysis supports the splitting of the Brachynemurini into 3 tribes (Gnopholeontini; Lemolemini; and Brachynemurini) and indicates a close relationship of Gnopholeontini with the Dendroleontini. The monophyly of the Gnopholeontini is supported by the autapomorphy of the close approximation of the larval mandibles (#20). The monophyly of the Lemolemini is supported by one larval autapomorphy not entered into the analysis: the presence of specialized setae along the median line of the abdomen. The monophyly of the Brachynemurini is supported by the elongate postventral of the ectoproct (#19) and larval dentition (#21). Finally, the monophyly of the Dendroleontini is supported by one larval autapomorphic character, namely the setae which hold debris on the mesonotum (not entered in data matrix).

Using the Dendroleontini and Nemoleontini as outgroups, the following phylogenetic analysis was made on genera of the Brachynemurini, Gnopholeontini and Lemolemini. The following informative characters were used, with the plesiomorphic condition and comments where relevant. The data matrix is given in Appendix 2. Characters #4, #22, #25, and #31 were treated as non-additive. Numbers in brackets indicate equivalence with list of tribal apomorphies.

List of generic apomorphies (adult)

HEAD CHARACTERS

1. Frons - (0) glabrous; (1) setose (Fig. 37)
Comments: The derived state is a synapomorphy of *Ameromyia* and *Venezueleon*.
2. Antennae - (0) similar in both sexes; (1) male antenna longer (more flagellomeres) than female
Comments: The derived state is a synapomorphy of *Brachynemurus* and *Scotoleon*.
3. Ocular rim setae - (0) absent; (1) present
Comments: The development of ocular rim setae appears correlated with the development of profemoral clavate setae. Usually there are two or more setae on the dorsal surface of the rim which vary in length from genus to genus. The derived state is a synapomorphy of *Abatoleon*, *Chaetoleon*, *Gnopholeon* (2 of 3 species) and *Menkeleon*. Also, ocular rim setae are found in some genera of the Acanthaclisini, Dendroleontini and Myrmecaelurini.

THORACIC CHARACTERS

4. Profemoral clavate setae (Fig. 9) - (0) absent; (1) present, arranged in a row; (2) clustered
Comments: The derived state is a synapomorphy of *Abatoleon* and *Chaetoleon*. In these genera there are at least four such setae in a row and in most *Abatoleon* there are secondary rows. In 2 of the 3 species of *Gnopholeon* these setae are clustered; this state is considered of independent evolution.
5. Femoral sense hair (Fig. 7) (#7) - (0) present; (1) absent
Comments: The derived state is a synapomorphy of *Atricholeon* and *Venezueleon*. The derived state is evidently a reversal to the primitive state found in Palparinae.
6. Profemoral sense hair - (0) much shorter than profemur; (1) as long as or longer than femur
7. Tibial spurs - (0) present; (1) absent
Comments: The derived state is a synapomorphy of *Maracandula*, *Menkeleon*, and *Tythholeon*. Tibial spurs are sporadically absent in *Brachynemurus* (2 species) and *Abatoleon* (1 species).

8. Pretarsal claws - (0) small to moderately large, less than one-half length of distal tarsomere; (1) enlarged, more than one-half length of distal tarsomere

WING CHARACTERS

9. Forewing, origin of vein CuP (#9) - (0) at or before crossvein m-cu; (1) distad of m-cu or CuP obsolete
Comments: The distal origin of vein CuP is a synapomorphy of the tribes Brachynemurini, Gnopholeontini and Lemolemini. Sometimes vein CuP is obsolete in these tribes. The character is very stable, the most basal position of CuP was observed in *Jaffuelia*. In a few groups of the Dendroleontini the origin of vein CuP may be distad of crossvein m-cu. Elsewhere in the Myrmeleontidae, this derived state is found in *Nannoleon* Esben-Petersen and in the tribe Maulini.
 10. Forewing, vein 2A - (0) runs at even curve toward 3A; (1) runs along 1A for short distance, then back at a sharp angle towards 3A (Nemoleontini)
 11. Hindwing, vein CuA - (0) bends to hind margin at or before medial fork; (1) runs along posterior branch of medial fork for some distance
Comments: The derived state is found in most genera of Brachynemurini albeit with some variation in expression. The most extreme expression of the derived state is found in the genus *Ameromyia* in the New World Brachynemurini.
 12. Hindwing, pilula axillaris (#14) - (0) present; (1) absent
Comments: The pilula axillaris is sometimes called "Eltringham's Organ". This structure, odoriferous in function, is found only in the male with a few exceptions (e.g. *B. longicaudus*). Although a unique character for the family, it appears to have been lost in some groups of the Myrmeleontinae (Nemoleontini; *Scotoleon*).
- #### ABDOMINAL CHARACTERS
13. Female terminalia, ectoproct - (0) with digging setae; (1) without digging setae
 14. Female terminalia, lateral gonapophyses - (0) separated (Figs. 17-20, 22-30); (1) partially fused (Fig. 21); (2) completely fused (Fig. 31)
Comments: The derived states are found in *Maracandula*, *Jaffuelia*, *Venezueleon* and *Ameromyia*.
 15. Female terminalia, lateral gonapophyses - (0) elongate (Figs. 17-19, 23-29); (1) transverse (Figs. 20-21, 30-32)
Comments: The derived state is found in the Gnopholeontini.

16. Female terminalia, posterior gonapophyses (#16) - (0) digitiform (Figs. 17-22); (1) inflated or greatly enlarged (Figs. 30-32)
 Comments: The derived state is found in the Gnopholeontini and the Lemolemini. Extreme expressions are found in *Maracandula* and *Neulatus*. Miller (1991) stated that the digitiform type is mostly used for soil depth testing whereas the inflated gonapophysis is associated with egg handling.
17. Female terminalia, posterior gonapophyses - (0) without scraping setae (Figs. 17-24); (1) with scraping setae (Fig. 25)
 Comments: The derived state is found in *Chaetoleon* and *Jaffuelia* and is associated with scraping the substrate prior to egg deposition.
18. Female terminalia, gonapophyseal plate - (0) narrower than posterior gonapophysis (Figs. 17-21); (1) wider than posterior gonapophysis (Figs. 22-27, 30-32)
 Comments: The derived state is found in Gnopholeontini and Dendroleontini. Although there is considerable variation in the size of the plate, I am dividing the state into 2 major groups using the width of the plate. Some interpretation is needed since although the plate is somewhat narrower than the gonapophysis in *Maracandula*, it is still very large and the discrepancy is due to the extremely inflated posterior gonapophysis in that genus. The Lemolemini is split into two groups. *Neulatus* and *Jaffuelia* have large gonapophyseal plates whereas *Elicura*, *Lemolemus* and *Sical* have narrower plates.
19. Female terminalia, pregenital plate - (0) with tooth (Figs. 24-26, 30-32); (1) without tooth (Figs. 17-18, 20)
20. Male ectoproct (#19) - (0) without elongate postventral lobe (Fig. 53); (1) with postventral lobe (Fig. 41-43, 47, 49)
21. Male ectoproct - (0) not produced ventrally (Figs. 47, 49); (1) produced ventrally (Figs. 51, 53)
 Comments: The apomorphic condition is best expressed in *Mexoleon*.
22. Male genitalia, genital sac - (0) without clubbed setae or secondary sclerites; (1) with clubbed setae (Fig. 48); (2) with lateral lobe-like sclerite; (3) with median setose sclerite near mediuncus (Fig. 44)
 Comments: The derived state (#1) is a synapomorphy of *Ameromyia* and *Venezueleon* whereas the extra sclerites are found in *Argentoleon* and *Atricholeon*. These derivatives are non-additive.
23. Male genitalia, parameres - (0) not-hinged (Figs. 57, 59); (1) with hinge (Figs. 46, 54, 56)
 Comments: The derived state is found in most genera of the Brachynemurini.
24. Male genitalia, paramere - (0) plate-like; (1) reduced to separate rods (Fig. 48)
 Comments: the apomorphic condition is found in *Ameromyia* and *Venezueleon*.
25. Male genitalia, sculpture of mediuncus - (0) smooth (non-spinose, not cross striate); (1) micro spinose (*Austroleon*); (2) cross-striate (Figs. 54, 59) (Gnopholeontini)
 Comments: The derived characters are non-additive.
- LARVAL CHARACTERS
26. Mandibles, (#20) - (0) widely separated (Figs. 60-67); (1) closely approximated (Figs. 68-71)
 Comments: The derived state is found in *Gnopholeon*, *Menkeleon* and *Tyitholeon*. Similar approximation occurs in many ascalaphid larvae.
27. Mandibular teeth (#21) - (0) 3 parallel teeth, usually increasing in length distally (Figs. 64-71); (1) distal tooth shorter than middle tooth, set at different angle (Figs. 60-63)
 Comments: The derived state is found in the Brachynemurini. This type of mandible is also found in the Old World Myrmecaelurini and Nesoleontini. See comments on tribal relationships (#21)
28. Hind pretarsal claw - (0) without basal tooth; (1) with basal tooth
 Comments: The derived state is a synapomorphy of *Neulatus* and *Jaffuelia*.
29. Mesothorax, chaetotaxy - (0) no specialized median setae;
 (1) with specialized setae medially on mesonotum, sometimes borne on common stalk (*Bankisus*; many Australian genera of Dendroleontini)
 Comments: The development of a medial group of elongate bristles on the mesonotum appears to be the best apomorphic characterization of the Dendroleontini. The function of the bristles is to hold a debris ball which acts as a lure to prey and represents a unique predator strategy in the antlions. In *Bankisus* and many Australian groups (Periclystrina) this structure is very long with the bristles fused as a common stalk.
30. Abdominal scoli - (0) absent; (1) present
 Comments: The development of abdominal scoli probably is related to living on rock surfaces or plants (*Gnopholeon*; *Jaffuelia*; *Neulatus*), paralleling the ascalaphid condition.

31. Abdominal tergites, chaetotaxy - (0) without specialized setae medially; (1) with dolichasters; (2) with black, tufted setae along midline

Comments: The derived state is found in the Lemolemini. There are two groups. Roseate, squat dolichasters are found in *Neulatus* and *Jaffuelia* whereas other lemolemine genera have tufted black setae.

Based on the character matrix given in Appendix 2, 3 separate analyses were made. The first analysis was made of the genera in which the larvae are known. The other 2 analyses included the 5 genera in which the larvae are unknown in order to determine phylogenetic relationships of these 5 genera.

The first analysis was made of 19 genera with larval information. Characters #4, 22, 25, and 30 were run as non-additive. The mhennig*/bb* option of Hennig86 resulted in 112 cladograms (length = 62; ci = 0.59; ri = 0.71). The successive approximations character weighting feature reduced the number of cladograms to 2 (ci = 0.87; ri = 0.93); character weights are given in Appendix 3.

The 2 cladograms (Figs. 3, 4) are nearly identical, differing only in the treatment of the loss of the medial tooth on the pregenital plate (#19). This is a homoplastic character appearing in several places in the cladogram. One cladogram (Fig. 3) has a trichotomy involving *Austroleon*, *Abatoleon* + *Argentoleon* + *Ensorra*, and the rest of brachynemurine genera. The other cladogram (Fig. 4) eliminates the trichotomy.

Examination of the 2 cladograms clearly shows that larval characters are most important for the discrimination of the three clades of the Brachynemurini s.l., now recognized as three tribes. The Gnopholeontini include *Gnopholeon*, *Menkeleon*, and *Tyttholeon*, and are defined by characters #15, 25-2 & 26. The Lemolemini are the sister group of the Gnopholeontini + Dendroleontini, defined by characters #13 & 31-2. Finally, the third large group of genera now comprising the Brachynemurini, are defined by character #27.

The genera of Gnopholeontini are well defined in both cladograms. *Tyttholeon* has no listed characters in this analysis but is abundantly characterized by autapomorphies such as the shape of the male ectoprocts (Fig. 50), enlarged pregenital plate (Fig. 30), and lanceolate setae on the larval meosternum.

The Lemolemini are defined by the adult autapomorphy of the loss of digging setae of the

female ectoproct (#13) and the larval autapomorphy of the development of specialized setae on the dorsal mesal margin of abdomen (#31-2). *Elicura* and *Lemolemus* have autapomorphies which support their monophyly: the sexual dimorphism of the tibial spurs in *Lemolemus* and the forefemoral setal comb and expanded forewing costal area in *Elicura*.

The Brachynemurini as newly restricted have several well defined subgroups. The South American genera *Austroleon*, *Abatoleon*, *Argentoleon*, and *Ensorra* are the sister group to the rest of the brachynemurine genera although this relationship is found in only 1 of the 2 weighted cladograms and is based on character #19, a very homoplastic character. *Ameromyia* + *Venezueleon* are defined as a clade by 3 autapomorphies. These two genera also are restricted to South America. The other 5 genera are all North American. Although both *Chaetoleon* and *Mexoleon* have the male ectoproct produced ventrally, in *Mexoleon* the process is much stronger and is considered an autapomorphy. Of all the genera treated in the analysis, only the original genus *Brachynemurus* has no apomorphies to defend it and will need further study.

To determine the relationships of the 5 genera of Brachynemurini for which larval data are missing, two additional analyses were done. The first was to add the five genera to the previous data matrix, coding the missing data as unknown. The mhennig*/bb* option of Hennig86 program was run and resulted in 3,248 cladograms (length = 67; ci = 0.56; ri = 0.71) before weighting. Successive approximation weighting produced 341 cladograms (ci = 0.84; ri = 0.92) with character weights given in appendix 5. A Nelson consensus tree of these weighted cladograms is given in Fig. 5. *Maracandula* comes out in the Gnopholeontini, *Ecualeon* and *Galapagoleon* in the Lemolemini, whereas *Dejuna* and *Clathroneuria* are shown to be related to genera comprising the tribe Brachynemurini s.s.

The second analysis was to run the 25 genera using only adult characters. This analysis was less informative regarding the relationships of the five genera. Using the mhennig*/bb* option of Hennig86, 3,503 cladograms were produced (length = 59; ci = 0.52; ri = 0.65). The successive approximations character weighting feature reduced the number of cladograms to 353 (ci = 0.80; ri = 0.90); character weights are given in appendix 6. A Nelson consensus tree (Fig. 6) was produced. The consensus tree exhibits considerably less resolu-

tion than the previous cladograms. The Gnopholeontini are resolved, but the genera of Lemolemini form a polytomy with the Dendroleontini and Gnopholeontini. The genera *Maracandula*, *Ecuaeon*, and *Galapagoleon* fall within the polytomy and their relationships are thus uncertain. The Brachynemurini s.s. are only partly resolved with *Abatoleon*, *Argentoleon*, *Austroleon* and *Ensorra* forming part of a basal polytomy for the entire tree. *Dejuna* and *Clathroneuria* fall out in this region.

Generic autapomorphies

LEMOLEMINI

Ecuaeon - (1) Female tergite VIII with egg handling setae (Fig. 33); (2) presence of large, scale-like setae on male abdominal segments III-V; (3) male ectoproct ventrally emarginate (Fig. 35).

Galapagoleon - Female posterior gonapophysis strongly curved (Fig. 23).

Elicura - Profemur with elongate white bristles on exterior face.

Jaffuelia - Larva with most of body covered with scale-like setae.

Neulatus - Apex of sternite VIII with median projection (Fig. 27); (2) pregenital plate modified as elongate, scoop-like structure (Fig. 27).

Sical - Female pregenital plate without median tooth.

GNOPHOLEONTINI

Gnopholeon - (1) Larval head greatly produced at anterolateral area, with long setae which camouflage mandible in trap position (Figs. 68, 69); (2) profemur with clavate setae clustered.

Maracandula - (1) Eye extremely reduced (Fig. 36); (2) antenna with flagellomeres 2-4 much longer than wide.

Menkeleon - Profemur with 2 sensory hairs.

Tyttholeon - (1) Female pregenital plate very expansive (Fig. 30); (2) male ectoproct produced mesally below (Fig. 50); (3) larva with specialized patch of lanceolate setae on mesothoracic sternum.

BRACHYNEMURINI

Abatoleon - (1) Mediuncus and the parameres of the male genitalia highly modified (Fig. 58)

Ameromyia - Enlarged pretarsal claws.

Argentoleon - Secondary, lobe-like sclerites laterally on genital sac.

Atricholeon - Secondary sclerotized and setose plates anterior to gonarcus (Fig. 44).

Austroleon - Male mediuncus micro-spinose.

Brachynemurus - The apically narrowed male ectoproct is autapomorphic for 8 of the 21 species (Fig. 42).

Chaetoleon - Posterior gonapophysis with scraping setae.

Clathroneuria - (1) Postventral lobe of male ectoproct with median lobe (Fig. 43). (2) mediuncus of male genitalia narrow and elongate (Fig. 46).

Dejuna - Male genitalia with gonarcus elongate, mediuncus with spiniform process, and parameres abbreviated (Fig. 45).

Ensorra - Male sternite IX extremely elongate (Fig. 49).

Mexoleon - Ventral process of male ectoproct spiniform or truncated (Figs. 51, 52).

Scotoleon - Modified tergal setae on male tergite IV (most species).

Venezueleon - Larval head capsule about as wide as long.

Key to tribes of Myrmeleontidae

Adults

1. Forewing vein CuP originates well distad of basal crossvein (Fig. 11) or obsolete; forewing vein 2A runs in fairly even curve to hind margin (Fig. 11)..... 2
 - Forewing vein CuP originates at or very near (about cubital vein diameter distad) basal crossvein (Fig. 10); forewing vein 2A variable 6
2. Labial palps longer than head width, sensory area extends at least to apex; mesofemoral sense

- hair absent, that of profemur small; southern Africa Maulini
- Labial palps shorter than head width, area not extending to apex; mesofemoral sense hair present, sometimes very small or absent in some genera (*Atricholeon*; *Venezueleon*) in which all leg setae are greatly reduced 3
3. Southern Africa; female terminalia with lateral gonapophysis elongate and with long downward curved setae which are longer than gonapophyseal width (Fig. 28); antennae close together, antennal fossae separated by less than pedicel width Myrmecaelurini (*Nannoleon*)
- New World; female terminalia with lateral gonapophysis small to moderately long, sometimes transverse, with or without digging setae, but when present not longer than gonapophyseal width (Figs. 17-22); antennal fossae usually separated by more than pedicel width 4
4. Male ectoproct with postventral lobe at least longer than diameter (Figs. 41-43, 47, 49) or profemur with row of clavate setae (*Chaetoleon*) (Fig. 9) or mesofemoral sense hair longer than femur (*Austroleon*); female terminalia with posterior gonapophysis subcylindrical (Figs. 17-22), sometimes greatly reduced Brachynemurini
- Male ectoproct without postventral lobe (rarely produced but then shorter than greatest diameter of lobe); profemur without row of clavate setae (clustered in *Gnopholeon*); mesofemoral sense hair much shorter than femur except in North American *Gnopholeon*; female posterior gonapophysis swollen thumb-like (Figs. 24-26, 30-32), distally swollen (Fig. 27), or strongly curved (Fig. 23, 34) 5
5. Tibial spurs absent (Fig. 40) or (in *Gnopholeon*) mesofemoral sense hair as long as or longer than femur; Sonoran Subregion (southwest United States; Mexico) Gnopholeontini
- Tibial spurs present (Figs. 38, 39); mesofemoral sense hair no more than 1/2 as long as femur; South America (Galapagos Islands; Ecuador; Chile; Argentina; south Brazil) Lemolemini
6. Hindwing vein CuA unites with posterior fork of MP₂ shortly after fork or (*Paranthaclisis*) metafemur with elongate sense hair; pretarsal claws strongly arched near base; tibial spurs strongly curved, sometimes bent at right angle; male abdomen with hair pencils (except *Arcuaplectron*) Acanthaclisini
- Hindwing vein CuA connected by crossveins to posterior fork of MP₂ or not reaching fork (Fig. 15); metafemur without sense hair (except *Sericoleon* and *Epacanthaclisis*); tibial spurs and pretarsal claws various, usually not strongly arched or bent; male abdomen without hair pencils (except Myrmecaelurini) 7
7. Forewing vein 2A runs in fairly even curve toward 3A (Fig. 11) 8
- Forewing vein 2A runs close to 1A for short distance, then bends at sharp angle toward 3A (Fig. 10) (modified in *Pachyleon* and *Xantholeon* of the Nemoleontini) 9
8. Hindwing posterior broad, nearly twice as high right before medial fork than corresponding area of forewing (similar to Fig. 14); origin of hindwing radial sector often near or beyond medial fork, often 3 or more presectoral crossveins; female anterior gonapophysis plate-like or membranous; lateral gonapophysis elongate with long, downward curved digging setae (Fig. 29) Myrmecaelurini (*Myrmecaelurina*)
- Hindwing posterior area less than 1.5 x higher than that of forewing before forks (Figs. 12, 13); origin of hindwing radial sector before medial fork, usually only 1 or 2 presectoral crossveins; female anterior gonapophysis often lobe-like; female lateral gonapophysis moderately long at most, digging setae if present shorter than gonapophyseal width Dendroleontini
9. Hindwing with 1 (rarely 2, 3) presectoral crossveins; male pilula axillaris always absent Nemoleontini
- Hindwing with 4 or more presectoral crossveins; male pilula axillaris present or absent 10
10. Basitarsus of hindleg longer than apical tarsomere; procoxa with elongate white bristles; female lateral gonapophysis with many long, downward curved digging setae as in Fig. 29 Nesoleontini
- Basitarsus of hindleg shorter than apical tarsomere; procoxa without white bristles; lateral gonapophysis without elongate, downward curved bristles Myrmeleontini
- ### Larvae
- (Larvae of Maulini and *Nannoleon* unknown)
1. Labial palpus shorter than basal width of mandible; mesothoracic spiracle not borne on tubercle; head without dolichasters; backward movement only (many genera) or backward and forward movement 2
- Labial palpus longer than basal width of mandible or mesothoracic spiracle borne on tubercle; head often with dolichasters; backward and forward movement 3

2. Mandible with some setae on outer lateral margin as long as or longer than greatest mandibular width; sternite VIII with pair of inconspicuous submedian teeth near posterior margin; make pitfall traps Myrmeleontini
Mandible with longest setae on outer lateral margin less than one-half greatest mandibular width; sternite VIII without teeth on subapical margin; do not make pitfall traps Acanthaclisini
3. Mandible bases separated by less than width of one mandibular base (Figs. 68-71); Sonoran subregion Gnopholeontini
Mandible bases separated more than width of one mandibular base (Figs. 60-67) 4
4. Mesoscutum with medial tuft of setae at middle; abdominal sternum IX usually at least as long as wide; mandibles up turned (best viewed in profile) Dendroleontini
Mesoscutum without medial tuft of setae; abdominal sternum IX wider than long; mandibles straight 5
5. Abdominal terga I-IV with specialized setae sagittally consisting of incurved setae or squat dolichasters; western and southern South America (especially Chile; Galapagos Islands) Lemolemini
Abdominal terga I-IV without specialized setae sagittally 6
6. Mandible with distal tooth shorter than middle tooth and usually set at different angle than other teeth (with 3 teeth only) Brachynemurini, Myrmecaelurini & Nesoleontini
Mandible with distal tooth as long as or longer than middle tooth, teeth parallel (few genera with 2 teeth) Nemoleontini

Tribe Brachynemurini Banks, 1927

= Austroleonini Banks, 1927

Adult Description: Labial palps short to moderately long, palpimacula not extending to apex; metafemur without sensory hair; pretarsal claws not toothed, rarely strongly bent near base; tibial spurs present or rarely absent (1 species of *Abatoleon*; 2 species of *Brachynemurus*) forewing vein CuP originates at or near crossvein M-Cu; 2A runs in a fairly even curve toward 3A, pilula axillaris present or absent; hindwing CuA connected by

crossveins to posterior fork of MP₂ or not reaching fork, Rs originates near or beyond medial fork, usually 3 or more presectoral crossveins, posterior area often broadened; male abdomen without hair pencils; male ectoproct usually with postventral lobe; male paramere often hinged; female anterior gonapophysis membranous or plate-like; gonapophyseal plate moderately large to very reduced; pregenital plate with or without median tooth; posterior gonapophysis cylindrical, often reduced; female ectoproct with digging setae (except *Ensorra*).

Larval Description: Labial palpus longer than basal width of mandible; mandibles not upcurved, separated by much more than basal width of mandible, with middle tooth closer to distal tooth than to basal tooth; distal tooth shorter than middle tooth, set at different angle; head often with dolichasters; mesothoracic spiracle pedunculate or not; mesonotum without medial bunch of debris-holding setae; sternite VIII with or without submedian tooth near posterior margin; abdomen without specialized setae along median line; without fossoria.

Discussion: The phylogenetic relationships of the Brachynemurini are difficult to understand. On the basis of the cladistic analysis of the higher categories (Fig. 1) and of genera previously contained in the Brachynemurini (Fig. 3), I am defining the Brachynemurini by the following apomorphies: (1) migration of forewing CuP well distad of crossvein m-cu (shared with Gnopholeontini, Lemolemini, Maulini, some Dendroleontini and *Nannoleon*); (2) cylindrical posterior gonapophyses (found in some Old World groups); (#3) short, deflected distal tooth of larval mandible (shared with Myrmecaelurini and Nesoleontini).

Additional apomorphies found in the Brachynemurini which help distinguish the tribe from the Gnopholeontini and Lemolemini are (1) the elongate postventral lobe of the male ectoproct (found in the majority of the genera) and (2) the hinged male paramere (found in 50% of the genera).

Key to genera of Brachynemurini

Adults

- Hindwing vein CuA bends to posterior margin at or before medial fork, only 1 or 2 crossveins between CuA and posterior fork of MP₂ (Fig.

- 12); posterior area of hindwing less than twice as high as corresponding area of forewing 2
- Hindwing vein CuA runs along posterior fork of MP₂ for a long distance, with 3 or more crossveins between them (Fig. 13); or posterior area of hindwing broad (Fig. 14), at least twice as high before medial fork as corresponding area of forewing 8
2. Profemur with clavate setae (Fig. 9); ocular rim usually with several short setae that project over eye 3
- Profemur without clavate setae; ocular rim without setae 4
3. Male ectoproct with postventral lobe at least twice as long as middle diameter; female terminalia with a membranous pregenital plate; (Fig. 19); posterior gonapophysis more than 4X as long as diameter at midlength, without scraping setae; Neotropics *Abatoleon* Banks
- Male ectoproct with postventral lobe never longer than diameter at midlength, sometimes absent (Fig. 53); female terminalia with sclerotized pregenital plate bearing median tooth; posterior gonapophysis at most 3X as long as diameter at midlength, with scraping setae; North America *Chaetoleon* Banks
4. Profemoral sense hair at least three-fourths as long as femur, or pretarsal claws longer than hind basitarsus (*Austroleon lizeri*) 5
- Profemoral sense hair (if present) no more than one-half length of femur; pretarsal claws longer or shorter than hind basitarsus 7
5. Male ectoproct with conspicuous median lobe in addition to postventral lobe (Fig. 43); female abdomen usually longer than wings; profemur and procoxa without row of long white bristles; temperate North America *Clathroneuria* Banks
- Male ectoproct without median lobe, sometimes without postventral lobe; profemur and procoxa sometimes with row of long white bristles; female abdomen usually shorter than wings; South America 6
6. Male ectoproct with postventral lobe at least 8x longer than middle diameter; profemur without row of long white bristles *Argentoleon* n. genus
- Male ectoproct without postventral lobe or if short lobe developed, less than 2x longer than wide; profemur with row of long white setae .. *Austroleon* Banks
7. Male sternite IX enlarged, nearly as wide as sternite VIII (Fig. 49); female ectoproct without digging setae (Fig. 20); apex of hindwing in repose coincides with apex of forewing; Argentina *Ensorra* Navás
- Male sternite IX much smaller than sternite VIII; female ectoproct with digging setae (Fig. 22); apex of hindwing in repose clearly extends beyond apex of forewing; Mexico to Costa Rica *Dejuna* Navás
8. Profemoral sense hair absent 9
- Profemoral sense hair present 10
9. Antennal fossae separated by about width of pedicel; frons without setae; forewing costal area with costal cells interconnected; male ectoproct with postventral lobe more than 6X as long as diameter at midlength (Fig. 41); North America *Atricholeon* n. genus
- Antennal fossae separated by about 2X width of pedicel; frons with setae; forewing costal area with cells not interconnected; male ectoproct with postventral lobe about as long as wide (Fig. 47); South America *Venezueleon* n. genus
10. Pretarsal claws as long as distal tarsomere; frons with numerous setae (Fig. 37); forewing CuP + 1A parallels posterior branch of CuA for a distance, about equal to that between hindwing CuA and posterior branch of MP₂; profemoral sense hair as long as femur; Venezuela to Argentina *Ameromyia* Banks
- Pretarsal claws much shorter than distal tarsomere (Fig. 38), or frons without setae; forewing CuP + 1A runs to posterior margin at or before posterior fork of MP₂; or profemoral sense hair shorter than femur; North America 11
11. Pretarsal claws shorter than hind basitarsus (Fig. 38); tibial spurs longer than greatest tarsomere diameter; male ectoproct with postventral lobe about as long as wide, ventrally with a short process (Fig. 51, 52) *Mexoleon* n. genus
- Pretarsal claws longer than hind basitarsus, or tibial spurs absent or vestigial; male ectoproct with postventral lobe longer than wide, not directed ventrally 12
12. Posterior area of hindwing broad (Fig. 14), at least twice as broad at medial fork as corresponding area of forewing; 4-6 crossveins between hindwing CuA and hind margin; male pilula axillaris absent; setal bases on male tergite IV often spined; vertex with dark pigment, when present, restricted to scars *Scotoleon* Banks
- Posterior area of hindwing narrow (Fig. 13), less than twice as wide at medial fork as corresponding region of forewing, more than 10

crossveins between CuA and hind margin of hindwing or (in *B. sackeni*) vertex scars yellowish with dark pigment in interscar area; setal bases on male tergite IV not spined; pilula axillaris present or absent
..... *Brachynemurus* Hagen

Larvae

1. Sternite VIII without a pair of well defined submedian teeth 2
Sternite VIII with a pair of sclerotized submedian teeth (Fig. 16) 3
2. Mesothoracic spiracle not borne on tubercle *Scotoleon*
Mesothoracic spiracle borne on tubercle
..... *Atricholeon* and *Dejuna*
3. Abdominal spiracles enlarged and/or borne on tubercles 4
Abdominal spiracles not enlarged or borne on tubercles 6
4. Mandible longer than head capsule, with distal tooth separated from middle tooth by at least length of distal tooth; mesothoracic spiracle borne on tubercle that is shorter than basal width *Mexoleon*
Mandible as long as head capsule, with distal tooth separated from middle tooth by less than 1/2 length of distal tooth; mesothoracic spiracle borne on tubercle that is longer than basal width 5
5. Mandible with distance between base and basal tooth longer than between basal and distal tooth; abdominal spiracles often with associated secondary tube-like structures; submedian teeth on sternite VIII shorter than basal widths *Abatoleon*
Mandible with distance between base and basal tooth equal to that between basal and distal tooth; abdominal spiracles without associated tube-like structures; submedian tooth of sternite VIII longer than basal widths
..... *Argentoleon* and *Austroleon*
6. North America 7
South America 8
7. Mandible elongate with distance between base and basal tooth much longer than between basal and distal teeth *Chaetoleon*
Mandible shorter with distance between base and basal tooth less than that between basal and distal teeth *Brachynemurus*

8. Ventral surface of head capsule with dolichasters 9
Ventral surface of head capsule without dolichasters 10
9. Head capsule longer than wide (measured ventrally); abdominal tergites with numerous thread-like setae between regular setae
..... *Ameromyia (modesta)* Group
Head capsule about as wide as long (measured ventrally); abdominal tergites without thread-like setae *Venezueleon*
10. Mesothoracic spiracle borne on tubercle that is longer than its basal width *Austroleon*
Mesothoracic spiracle borne on tubercle that is shorter than its basal width 11
11. Submedian teeth of sternite VIII weakly developed, shorter than basal widths; head capsule (dorsal view) longer along dorsal midline than across ocular tubercles; distance between basal and distal teeth less than distance between base and first tooth *Abatoleon*
Submedian teeth of sternite VIII well developed, longer than basal widths; head capsule shorter along dorsal midline than across ocular tubercles; distance between basal and distal teeth longer than that between base and first mandibular tooth
..... *Ameromyia (nigriventris)* Group

1. *Abatoleon* Banks (Figs. 19, 58)

Abatoleon Banks, 1924. Bull. Mus. Comp. Zool. 65:436.

Type species: *Abatoleon deprivatum* Banks, by monotypy.

Adult Description: Frons without setae; antennal fossae separated by about width of pedicel; profemur with clavate setae (sometimes weakly thickened subapically); ocular rim with or without setae that project over eye; femoral sense hair of foreleg about as long as femur and much longer than that of midleg; mesonotum without bladlike setae; tibial spurs present (except *A. deprivatus* Banks in Argentina); pretarsal claws longer than hind basitarsus but less than 1/2 length of distal tarsomere; pilula axillaris present; hindwing shorter than forewing, in repose apex of wings nearly coincide; banksian lines absent; costal area of forewing with one series of cells for most of distance; posterior area of hindwing narrower than presectoral area, CuA bends to hind margin at or

before origin of medial fork; antenna short, usually with less than 30 flagellomeres; postventral lobe of male ectoproct well developed but less than one-half length of eighth abdominal segment (except *A. frontalis*; *A. deprivatus*), without median or secondary lobes; gonarcus reduced, mediuncus of male genitalia smooth, conspicuously expanded covering modified parameres; genital sac without secondary sclerites or clavate setae; female terminalia with pregenital plate membranous; gonapophyseal plate long and slender; lateral gonapophysis separate, with weak digging setae; ectoproct with digging setae; posterior gonapophysis elongate, sometimes somewhat swollen.

Larval Description (based on *dorsalis*, *indiges*, and several undescribed Peruvian species):

Head capsule with or without dolichasters; basal tooth is closer to distal tooth than to mandibular base; mesothoracic spiracle borne on tubercle that is longer than wide; abdominal spiracles sometimes borne on tubercles; submedian teeth on sternite VIII present, shorter than basal widths.

Included species: *bruneri* (Alayo), *camposi* (Banks), *deprivatus* Banks, *dolichogaster* (Navás), *dorsalis* (Banks), *frontalis* (Banks), *garciana* (Banks); *indiges* (Walker).

Distribution: Nearctic and Neotropical Region (Florida Keys; Caribbean Islands; Southwestern Texas to Argentina).

Discussion: The presence of clavate setae on the profemur distinguishes this genus from all others in the subtribe except for *Chaetoleon*. However, sometimes the setae are only weakly thickened apically. The elongate male postventral ectoproct lobe and the autapomorphic mediuncus and parameres of the male genitalia distinguish this sex. In several characteristics *Abatoleon* parallels *Dejuna*; both have highly specialized male genitalia, similar wing venation, and are restricted to tropical climates.

The present center of diversity of *Abatoleon* is South America, especially in the Peruvian coastal desert and Argentina. Many undescribed species exist in Peru. The two aberrant Argentinian species, *A. frontalis* (Banks) and *A. deprivatus* Banks, may belong to a different genus. These two species have short abdomens and very elongate male postventral ectoproct lobes, and *deprivatus* lacks

tibial spurs. Also, these two species lack digging setae on the female ectoproct. *Abatoleon* is the only Neogeic element of the Brachynemurina present in continental North America. One species, *A. indiges*, has reached the Florida Keys, having apparently dispersed from South America via the Caribbean islands. The other North American representative, *A. dorsalis*, is found throughout most of Mexico and is established in southern Texas. Known North American larvae have enlarged abdominal spiracles, but this character is known to be variable among South American species.

2. *Ameromyia* Banks (Fig. 37)

Ameromyia Banks, 1913. Trans. Amer. Ent. Soc. 39:227. **Type species:** *Brachynemurus strigosus* Banks, by original designation.

=*Amazoleon* Banks, 1913. Trans. Amer. Ent. Soc. 39:229 (after Stange 1967:45). **Type species:** *Myrmeleon pubiventris* Walker, by original designation.

=*Foya* Navás, 1914. Broteria 12:53 (after Esben-Petersen 1920:190). **Type species:** *Foya trapezia* Navás, by original designation.

=*Nemotolus* Banks, 1943. Bol. Ent. venezolana 2:163 (after Stange 1967:45). **Type species:** *Myrmeleon protensis* Gerstaecker, by original designation.

Adult Description: Frons with setae; antenna of same length on both sexes, moderately short with about 30 flagellomeres; antennal fossae separated by about 2X pedicel width; profemur without clavate setae; ocular rim without setae; femoral sense hair of proleg as long as femur and much longer than that of mesoleg; mesonotum without blade-like setae; tibial spurs present; pretarsal claws nearly as long as distal tarsomere; pilula axillaris large; hindwing as long as forewing or shorter; anterior banksian line present in both wings; forewing costal area simple; posterior area of hindwing about as broad as that of forewing; forewing vein CuP + 1A runs along posterior fork of CuA for long distance; hindwing CuA runs along posterior fork of medial fork for a long distance; postventral lobe of male ectoproct developed, usually less than 3X longer than middle diameter; without median or secondary lobes; male genitalia highly modified, gonarcus reduced, mediuncus smooth, greatly expanded covering modified rod-like parameres; genitalic sac with clavate setae; female terminalia with pregeni-

tal plate membranous; gonapophyseal plate short; lateral gonapophysis fused, with well developed digging setae; ectoproct with well developed digging setae.

Larval Description (based on *modesta* and *nigriventris*): Head capsule with dolichasters; mandible with distance between base and basal tooth less than between teeth; head capsule a little longer than wide (measured ventrally) with or without dolichasters; mesothoracic spiracle borne on tubercle; abdominal tergites sometimes with thread-like setae; abdominal spiracle not enlarged nor borne on tubercles; submedian tooth on sternite VIII longer than basal width.

Included species: *dimidiata* Navás, *longiventris* (Navás), *hirsuta* Navás, *modesta* (Banks), *muralli* Navás, *nigriventris* (Walker), *pentheri* Navás, *pleuralis* Navás, *pubiventris* (Walker), *protensus* (Gerstaecker), *stevensi* Navás, *strigosa* (Banks), and *tendinosa* (Gerstaecker).

Geographic Range: South America east of the Andes.

Discussion: This is a distinctive genus in which the pretarsal claws are greatly enlarged and the male genitalia highly modified. The same modified male genitalia are found in *Venezueleon*. The setose frons is shared only with *Venezueleon*. The profemoral sense hair is extremely long, but the mesofemoral sense hair is quite short. There are two species groups. Larvae of the *A. modesta* Group have thread-like setae on the abdominal tergites whereas the *nigriventris* group lack these setae. Larvae have been found living in sand dunes. The larval head capsule is relatively wide, but less so than in the related *Venezueleon*.

3. *Argentoleon* Stange, new genus

Type species: *Myrmeleon irrigatus* Gerstaecker, 1893, by present designation.

Adult Description: Frons without setae; antenna short, same length in both sexes, about 30 flagellomeres; antennal fossae separated by about width of pedicel; profemur without clavate setae; ocular rim without setae; profemoral sense hair as long as profemur and as long as mesofemoral sense hair; mesonotum without blade-like setae; tibial spurs present; pretarsal claws large, longer than

one-half length of distal tarsomere; pilula axillaris large; hindwing shorter than forewing, in repose apices of wings nearly coincide; costal area of forewing with one series of cells; posterior area of hindwing narrower than presectoral area, CuA bends to hind margin at or before origin of medial fork; anterior banksian line weakly developed; postventral lobe of male ectoproct more than 8 times longer than middle diameter, without secondary lobes; male paramere plate-like, without hinge; genital sac with lateral lobe-like sclerite; mediuncus smooth; female terminalia with pregenital plate membranous, without median tooth; gonapophyseal plate narrow, short, not transverse; lateral gonapophyses separated, with strong digging setae; ectoproct with digging setae; posterior gonapophyses without scraping setae.

Larval Description (Based on *A. irrigatus*): Head capsule with dolichasters; mandible with distance between base and basal tooth about equal to that between teeth; mesothoracic spiracle borne on tubercle that is longer than basal width; abdominal spiracles weakly raised; submedian tooth on sternite VIII longer than basal width.

Included species: *irrigatus* (Gerstaecker) & *longitudinalis* (Navas).

Distribution: South America east of the Andes.

Discussion: *Argentoleon* has one autapomorphy, the development of secondary, lobe-like sclerites from the genital sac. The enlarged pretarsal claws, and elongate femoral sense hairs relate this genus to *Austroleon* and *Ameromyia*. The latter genus has many apomorphic characters (clavate setae of the male genitalia; form of the male parameres; shape of forewing vein CuP + 1A) which relate it to *Venezueleon* and less to *Argentoleon*. One variable species, *A. irrigatus*, ranges from Venezuela to Patagonia with some striking geographic forms. In Patagonia, the individuals are much smaller than elsewhere in its range. *A. longitudinalis* (Navas) may only be a geographic variant of *A. irrigatus*, but evaluation of the geographic variation present in *A. irrigatus* is needed to determine the validity of *longitudinalis*. The larva was found in sand on a grassy slope and resembles closely the larva of *Austroleon*.

4. *Atricholeon* Stange, new genus (Figs. 41, 44)

Type species: *Brachynemurus parkeri* Stange, by present designation.

Adult Description: Frons without setae; antennal fossae separated by about width of pedicel; profemur without clavate setae; ocular rim without setae; femoral sense hair absent; mesonotum without bladeliike setae; tibial spurs present; pretarsal claws shorter than hind basitarsus and less than one-half length of distal tarsomere; pilula axillaris small with setae restricted to apical margin of knob; hindwing shorter than or nearly equal to forewing; anterior banksian line weakly developed; costal area of forewing mostly biareolate; posterior area of hindwing narrower than presectoral area at radial sector although wider than prefork area; CuA runs along posterior fork of MP_2 for a short distance; antenna relatively long, usually with more than 40 flagellomeres; postventral lobe of male ectoproct longer than abdominal segment VIII, without a median lobe; gonarcus simple; smooth mediuncus which is small hooded process; paramere hinged, with elongate hook; secondary sclerotized and setose plates present anterior to gonarcus; female terminalia with pregenital plate membranous, without a median tooth; median floor with sclerotization medially and subapically; lateral gonapophysis separate, with very strongly developed digging setae; ectoproct with strongly developed digging setae, gonapophyseal plate relatively short and with fine striae.

Larval Description (based on *parkeri*): Head capsule with dolichasters; mandible with distance between base and basal tooth less than between teeth; mesothoracic spiracle borne on tubercle; abdominal spiracles not enlarged; submedian tooth on sternite VIII reduced to bulge.

Included species: *parkeri* (Stange) and *tuberculatus* (Banks).

Distribution: Mexico, Arizona, and New Mexico.

Discussion: The reduction in leg setae, particularly the loss of the femoral sense hair, is an apomorphy of this genus. This condition is duplicated only in *Dejuna mimica* and *Venezueleon*. The

development of sclerotized and setose plates anterior to gonarcus is an autapomorphy.

The two known species differ by numerous structural details and are completely allopatric. *A. tuberculatus* is found only north of the Neovolcanic Plateau of Mexico whereas *A. parkeri* occurs south of this plateau. *A. tuberculatus* appears to be more highly derived than *A. parkeri* in characters of the male genitalia, male ectoproct, and vertex protuberances. The strongly humped mesoscutellum of *parkeri* is apomorphic for that species.

5. *Austroleon* Banks

Austroleon Banks, 1909. J. New York Ent. Soc. 17:3.

Type species: *Austroleon dispar* Banks, by subsequent designation by Banks 1927:53.

=*Moza* Navás, 1912. Broteria 10:34 (after Stange 1967:47). **Type species:** *Moza nubilis* Navás, by original designation.

=*Correa* Navás, 1914. Broteria 12:217 (after Stange 1967:47). **Type species:** *Correa expansus* Navás, by original designation. Preoccupied by Correa Fauvel, 1878 (Coleoptera).

=*Clotus* Navás, 1922. Rev. Acad. Madrid 19:257 (after Stange 1967:48). **Type species:** *Clotus atomicus* Navás, by original designation.

=*Carreo* Navás, 1926. Broteria 23:5. New name for *Correa* Navás, 1914.

Adult Description: Frons without setae; antenna short, usually about 30 flagellomeres; antennal fossae separated by about width of pedicel; profemur without clavate setae, but comb of setae present; ocular rim without setae; profemoral sense hair as long as or shorter than profemur (except male *A. lizeri*) and as long as mesofemoral sense hair; mesonotum without blade-like setae; tibial spurs present; pretarsal claws longer than one-half distal tarsomere; pilula axillaris large; hindwing shorter than forewing, in repose apices of wings nearly coincide; costal area of forewing with one series of cells; posterior area of hindwing narrower than presectoral area, CuA bends to hind margin at or before origin of medial fork; anterior banksian line weakly developed or absent; postventral lobe of male ectoproct absent or weakly developed (less than 2X longer than wide); without median or secondary lobes; male paramere plate-like, without hinge; mediuncus micro spinose; female terminalia

with pregenital plate membranous, without median tooth; gonapophyseal plate narrow, short, not transverse; lateral gonapophyses separate, with strong digging setae; ectoproct with digging setae.

Larval Description (based on *immitus*; *lizeri*):

Head capsule with dolichasters; mandible with distance between base and basal tooth about equal to that between teeth; mesothoracic spiracle borne on tubercle that is longer than basal width; abdominal spiracles weakly raised; submedian tooth on sternite VIII longer than basal width.

Included species: *dispar* Banks, *immitus* (Walker), *lizeri* (Navás).

Distribution: South America east of the Andes.

Discussion: *Austroleon* is apomorphically defined by the microspinose male mediuncus. The elongate femoral sense hair of both the proleg and mesoleg is found in all species except for male *A. lizeri* which has a shorter femoral sense hair. Larvae of two species have been found in sand dunes in Venezuela (*A. immitus*) and Argentina (*A. lizeri*). Based on larval exuviae these 2 larvae differ more from each other than does *A. immitus* from the larvae of *Argentoleon irrigatus*.

6. *Brachynemurus* Hagen
(Figs. 11, 13, 16, 17, 42)

Brachynemurus Hagen, 1888. Canadian Ent. 20:34.

Type species: *Myrmeleon longicaudus* Burmeister, by subsequent designation of Banks 1899.

=*Calinemurus* Banks, 1899. Canadian Ent. 31:70 (after Stange 1970:51). **Type species:** *Brachynemurus californicus* Banks, by original designation.

=*Hesperoleon* Banks, 1913. Entomol. News 24:64 (after Stange 1970:51). **Type species:** *Myrmeleon ferox* Walker, by original designation.

=*Mastega* Navás, 1914. Bull. Brooklyn Ent. Soc. 9:13 (after Stange 1970:51). **Type species:** *Mastega texanus* Navás (= *B. irregularis* Currie), by monotypy.

=*Comptesa* Navás, 1915. Mem. R. Acad. Cien. Barcelona (Ser. 3) 11:464 (after Banks 1942:139). **Type species:** *Comptesa ambitiosa* Navás, (= *B. californicus* Banks), by monotypy.

=*Belluga* Navás, 1920. Ann. Soc. Sci. Bruxelles 39:194 (after Banks 1942:139). **Type species:** *Belluga*

implexa Navás (= *Brachynemurus californicus* Banks), by monotypy.

=*Netroneurus* Banks, 1927. Bull. Mus. Comp. Zool. Harv. 68: 42. **Type species:** *Brachynemurus carolinus* Banks, by original designation.

=*Bollenga* Navás, 1932. Bull. Mus. Zool. Torino (Ser. 3) 42:13. **Type species:** *Bollenga dinamitensis* Navás (= *Brachynemurus sackeni* Hagen).

Adult Description: Frons without setae; antenna at least moderately long with more than 30 flagellomeres, that of male longer and less clavate than in female; antennal fossae separated by less than width of pedicel; profemur without clavate setae; ocular rim without setae; femoral sense hair elongate, that of profemur longer than that of mesofemur but shorter than length of femur; mesonotum without blade-like setae; tibial spurs present or absent (*nebulosus* and *signatus*); pretarsal claws equal to or longer than hind basitarsus but less than one-half length of distal tarsomere; pilula axilaris present or absent; hindwing equal to or shorter than forewing; anterior banksian line usually well developed; costal area of forewing sometimes biareolate, narrower above radial sector than greatest presectoral area; posterior area of hindwing moderately broadened (except *B. sackeni*); much broader near base than at medial fork, CuA runs along posterior fork of MP₂ for a long distance; postventral lobe of male ectoproct well developed but less than one-half length of abdominal segment VIII (except *B. sackeni*), without secondary lobes but narrowed preapically in many species; male genitalia ordinary with simple gonarcus and smooth mediuncus, paramere with hinge and hook; female terminalia with pregenital plate large, sclerotized, with small median tooth anteriorly; gonapophyseal plate moderately expansive; lateral gonapophyses separate, with digging setae; ectoproct with digging setae.

Larval Description (based on *carolinus*, *divisus*, *exigua*, *ferox*, *longicaudus*, *nebulosus*, *ramburi*, *sackeni*, *seminolae*): Head capsule with dolichasters; mandible with distance between base and basal tooth less than that between teeth; mesothoracic spiracle borne on tubercle; abdominal spiracles not enlarged nor borne on tubercles; submedian tooth on sternite VIII shorter than basal width.

Included species: *abdominalis* (Say), *blandus* (Hagen), *californicus* Banks, *carolinus* Banks, *divisus* Navás, *elongatus* Banks, *exigua* (Navás), *ferox* (Walker), *fuscus* (Banks), *hubbardi* Currie, *irregularis* Currie, *longicaudus* (Burmeister), *mexicanus* Banks, *henshawi* (Hagen), *nebulosus* (Olivier), *pulchellus* Banks, *ramburi* Banks, *B. sackeni* Hagen, *B. seminolae* Stange, *B. signatus* (Hagen), and *B. versutus* (Walker).

Distribution: Nearctic region to about 50° N latitude and south to southern Mexico.

Discussion: There is a great deal of structural diversity in this group, making it difficult to characterize as a whole. No synapomorphies are known for the genus, consequently it may prove to be a paraphyletic assemblage. The modified male ectoproct (Fig. 42) is common to about one-third of the component species. Tibial spurs may be prominent, minute, or absent. The pilula axillaris may be well developed, weakly developed, or absent. The parallel tracks of the CuA and posterior fork of MP₂ in the hindwing are a unifying generic characteristic, except for *B. sackeni*. The genus shares with *Scotoleon* the synapomorphy of antennal sexual dimorphism. Larvae have been found in open sand, e.g. sand dunes.

7. *Chaetoleon* Banks (Figs. 7, 53, 54)

Chaetoleon Banks, 1920. Bull. Mus. Comp. Zool. 64:328.

Type species: *Myrmecoleon pumilis* Burmeister, by original designation.

Adult Description: Frons without setae; antenna moderately long to very long; antennal fossae separated by less than width of pedicel; profemur with row of clavate setae; ocular rim with several short setae that project over eye; femoral sense hair of proleg much shorter than tarsus, longer than that of midfemur; mesonotum with conspicuous, weakly flattened or bladelike bristles; tibial spurs present; pretarsal claws longer or shorter than hind basitarsus, not longer than one-half length of distal tarsomere; pilula axillaris small with setae restricted to distal margin of knob; hindwing shorter than forewing, in repose apices coincide; banksian lines absent; forewing costal area with single series of cells; posterior area of hindwing narrower than presectoral area before radial sector, CuA bends to hind margin at or near medial fork; postventral

lobe of male ectoproct simple or weakly produced, about as broad as long, without median lobe but sometimes produced ventrally; male genitalia rather ordinary, paramere with hinge and weakly developed hook; female terminalia with pregenital plate sclerotized with a small median tooth; gonapophyseal plate large; posterior gonapophysis with scraping setae; lateral gonapophyses separate, with digging setae.

Larval Description (based on *pusillus*): Head capsule with many dolichasters; mandible with distance between base and basal tooth longer than between teeth; mesothoracic spiracle borne on weak tubercle; abdominal spiracles not enlarged nor borne on tubercles; submedian tooth on sternite VIII shorter than basal width.

Included species: *pumilis* (Burmeister), *pusillus* (Currie), *tripunctatus* (Banks) and *variabilis* (Banks).

Distribution: North America.

Discussion: The presence of profemoral clavate setae distinguishes *Chaetoleon* from all other Brachynemurine genera except *Abatoleon*. The presence of scraping setae on the female posterior gonapophysis is an autapomorphy of *Chaetoleon* and diagnostic within the Brachynemurini. Relationship with *Mexoleon* is indicated by a weak ventral lobe of the male ectoproct (compared with a strong ventral lobe in *Mexoleon*). There are two very distinct species groups. The *C. pumilis* group has a simple male ectoproct, more elongate legs and antennae, blade-like mesoscutal bristles, and more weakly swollen posterior gonapophyses relative to the *C. tripunctatus* Group. One species, *C. pusillus*, has a bag-like structure on the male postmentum. The larva of *C. pusillus* has been found in sand under plants. *Chaetoleon variabilis* has the female scraping setae less developed than in other species.

8. *Clathroneuria* Banks (Figs. 43, 46)

Clathroneuria Banks, 1913. Entomol. News 24:65.

Type Species: *Brachynemurus schwarzi* Currie, by original designation.

Adult Description: Frons without setae; antenna moderately long with over 30 flagellomeres; antennal fossae separated by less than width of pedicel;

profemur without clavate setae; ocular rim without setae; femoral sense hair of proleg unusually long (as long as femur), over twice as long as that of midfemur; mesonotum without bladelike setae; tibial spurs present; pretarsal claws much longer than hind basitarsus and more than one-half as long as distal tarsomere. Pilula axillaris small with setae restricted to apical margin of knob; hindwing shorter than forewing, in repose wing apices nearly coincide; anterior banksian line usually well developed; posterior area of hindwing narrower than presectoral area just before radial sector (except *coquilletti*), CuA bends to hind margin before medial fork or runs along posterior fork of MP_2 for a short distance; forewing costal area with single series of cells; postventral lobe of male ectoproct with a median lobe in addition to postventral lobe (Fig. 43); mediuncus smooth, long and narrow; paramere hinged without hooks (Fig. 46); female terminalia with pregenital plate sclerotized with a small median tooth; gonapophyseal plate expansive, about as in *Dejuna* (Fig. 22); lateral gonapophyses separate, with digging setae; ectoproct with digging setae.

Larval Description: Larvae unknown.

Included Species: *arapahoe* Banks, *coquilletti* (Currie), *navajo* Banks, *schwarzi* (Currie), *westcotti* (Stange).

Distribution: Southwestern USA and Northern Mexico.

Discussion: The unusual male ectoproct (Fig. 43), in which a median lobe is developed in addition to the postventral lobe is a diagnostic and autapomorphic character for this genus. Male genitalia are also distinctive in having an unusually narrowed and elongate mediuncus. A longer femoral sense hair helps to identify the female sex. *B. coquilletti* is the only species in the group having a broad hindwing posterior area, one similar to that found in *Scotoleon*, and a short male ectoproct lobe. Although large populations of adults of both *C. coquilletti* and *C. schwarzi* have been discovered many times, all attempts to find larvae have failed.

9. *Dejuna* Navás (Figs. 12, 22, 45)

Dejuna Navás, 1924. Broteria 21:57. **Type Species:** *Dejuna angusta* Navás, by original designation.

Adult Description: Frons without setae; antenna short, usually with less than 30 flagellomeres; antennal fossae separated by about width of pedicel or more (*D. mimica*); profemur without clavate setae; ocular rim without setae; femoral sense hair various (absent in *mimica*), that of profemur longer than that of midfemur but shorter than length of femur; mesonotum without blade-like setae; tibial spurs present; pretarsal claws longer than hind basitarsus, no longer than one-half length of distal tarsomere; pilula axillaris large with setae densely clustered on dorsal face of knob; hindwing as long as forewing, in repose apex of hindwing extends beyond that of forewing; anterior banksian line weakly developed; costal area of forewing with one series of cells for most of distance; posterior area of hindwing narrower than presectoral area, CuA bends to hind margin at or before medial fork; postventral lobe of male ectoproct longer than tergite VIII, without a median lobe; gonarcus of male genitalia elongate, mediuncus with a spiniform process, parameres abbreviated (Figs. 59, 60); female terminalia with pregenital plate membranous or sclerotized, without median tooth; gonapophyseal plate large (Fig. 30); lateral gonapophyses separate, with digging setae; female ectoproct with digging setae.

Larval Description: Presumed larvae of *D. mimica* have recently been discovered in Honduras and are being reared. They agree closely with larvae of *Atricholeon*.

Included Species: *fenestrata* (Banks) (= *angusta* Navas), *mimica* (Stange), *persimila* (Stange), *setosa* (Stange), and *straminea* (Stange).

Distribution: Arid tropical areas of North and Central America.

Discussion: The male genitalia (Figs. 59, 60) are autapomorphic for the genus. *D. mimica* which lacks femoral sense hairs, has abbreviated pretarsal claws and tibial spurs, exhibits reduced leg setae, and has a small distal palpimere with reduced palpimacula parallels in many ways species of *Atricholeon*.

10. *Ensorra* Navás (Figs. 20, 49)

Ensorra Navás, 1915. Broteria 13:10. **Type Species:** *Ensorra modestus* Navás, by original designation.

Adult Description: Frons without setae; antenna short with about 28 flagellomeres; antennal fossae separated by about width of pedicel; profemur without clavate setae; ocular rim without setae; femoral sense hair short on proleg and mesoleg; mesonotum without bristles; tibial spurs present; pretarsal claws about equal to basitarsus and much shorter than one-half length of distal tarsomere; hindwing shorter than forewing, in repose apices of wings coincide; pilula axillaris present; costal area of forewing simple; banksian lines absent; posterior area of hindwing narrower than presectoral area just before radial sector; hindwing vein CuA reaches hind margin about at level of medial fork; banksian lines absent; male ectoproct with elongate postventral lobe; male sternite IX unusually long; male genitalia with simple gonarcus, smooth mediuncus and plate-like parameres; pregenital plate of female sclerotized, without median tooth; gonapophyseal plate narrow, elongate, not transverse; lateral gonapophyses separate, with digging setae; ectoproct without digging setae.

Larval Description (based on *verticalis*): Mandible with distance between base and basal tooth less than that between teeth; mesothoracic spiracle borne on tubercle; abdominal spiracles not modified; submedian tooth on sternite VIII shorter than basal width.

Included Species: *verticalis* (Banks) (= *modestus* Navás).

Distribution: Argentina.

Discussion: This genus contains a single small species restricted to Argentina. The outstanding autapomorphy of this species is the enlargement of male sternite IX (Fig. 49). The lack of clavate profemoral setae and setal comb, absence of digging setae on the female ectoproct, the presence of short pretarsal claws and profemoral sense hair distinguish this species from other South American *Brachynemurini*. The larva resembles that of *Scotoleon pallidus* but the only larva available for examination is damaged and therefore not keyed. The larva makes a pitfall trap.

11. *Mexoleon* Stange, new genus (Figs. 38, 51, 52)

Type Species: *Brachynemurus mixtecus* Stange, by present designation.

Adult Description: Frons without setae; antenna with more than 35 flagellomeres; antennal fossae separated by less than width of pedicel; profemur without clavate setae; ocular rim without setae; femoral sense hair moderately long (subequal in length to distal tarsomere of proleg), that of profemur about equal in length to that of midfemur; mesonotum without blade-like setae; tibial spurs and pretarsal claws shorter than hind basitarsus, latter shorter than one-half distal tarsomere; pilula axillaris with setae restricted to distal margin of knob; hindwing shorter than forewing, in repose apices coincide; anterior banksian line poorly developed; posterior area of hindwing narrower than greatest width of presectoral area, about as broad at base as at medial fork, CuA runs along posterior branch of medial fork a short distance; forewing costal area at radial sector much narrower than greatest presectoral width, with one series of cells; postventral lobe of male ectoproct barely produced, about as wide as long, ectoproct produced ventrally into a process (Fig. 112); male genitalia with hinged paramere and smooth mediuncus; genital sac without secondary sclerites, and clavate setae; female terminalia with pregenital plate sclerotized, with a median tooth anteriorly; gonapophyseal plate moderately large (about as in Fig. 30); lateral gonapophyses separate, with digging setae; ectoproct with strong digging setae.

Larval Description (based on *papago*): Head capsule depressed posteriorly, with dolichasters, many very short; mandible elongate, not broadened subbasally, with distance between base and basal tooth shorter than that between basal and distal teeth; mesothoracic spiracle borne on tubercle that is about as long as basal width; abdominal spiracles enlarged, raised; submedian teeth on sternite VIII longer than basal widths.

Included Species: *mixtecus* (Stange) and *papago* (Currie).

Distribution: Arid tropical regions of southern Mexico and montane regions of southwestern United States and northern Mexico.

Discussion: The male ectoproct which is produced ventrally (Fig. 52) is diagnostic and synapomorphic for the genus, although it is approached in structure by species of *Chaetoleon*. *Mexoleon*, however, lacks the clavate profemoral setae of *Chaetoleon*.

12. *Scotoleon* Banks (Figs. 8, 14, 18, 60-63)

Scotoleon Banks, 1913. Ent. News 24:64. **Type Species:** *Brachynemurus longipalpis* Hagen, by original designation.

Adult Description: Frons without setae; antenna short or elongate, usually longer and less clavate in male; antennal fossae separated by about width of pedicel; profemur without clavate setae; ocular rim without setae; femoral sense hair of proleg much shorter than distal tarsomere, not much longer than that of mesoleg; mesonotum without blade-like seta; tibial spurs evident; pretarsal claws longer than hind basitarsus but not longer than one-half length of distal tarsomere; pilula axillaris absent; hindwing shorter than forewing, in repose apices nearly coincide; anterior banksian line present; forewing costal area with only one series of cells; hindwing posterior area greatly broadened, about as broad near medial fork as basally, usually with 6 or fewer crossveins between CuA and posterior margin; CuA diverges to hind margin along posterior fork of MP_2 (Figs. 37, 38); postventral lobe of male ectoproct short to elongate, without secondary lobes; male genitalia ordinary with simple arched gonarcus and smooth mediuncus; paramere with hinge and hook (except *S. expansus* and *S. yavapai*); genital sac without secondary sclerites (except *carrizonus* and *nigrescens*); female terminalia with pregenital plate sclerotized, without a median tooth; gonapophyseal plate small (Fig. 32); lateral gonapophyses separate, with digging setae; ectoproct with digging setae.

Larval Description (based on all species except *marshi*, *nigrescens*, *yavapai*): Head capsule without dolichasters; mandible with distance between base and basal tooth less than between basal and distal teeth; mesothoracic spiracle not borne on tubercle; abdominal spiracles not enlarged; sternite VIII without submedial teeth.

Included Species: *carrizonus* (Hagen), *deflexus* (Adams), *dissimilis* (Banks), *eiseni* (Banks), *expansus* (Navás), *fidelitas* (Adams), *infuscatus* (Adams), *intermedius* (Currie), *longipalpis* (Hagen), *marshi* (Stange), *minusculus* (Banks), *minutus* (Adams), *niger* (Currie), *nigrescens* (Stange), *nigrilabris* (Hagen), *nivatensis* (Navás), *pallidus* (Banks), *peninsularis* (Banks), *peregrinus* (Hagen),

quadripunctatus (Currie), *singularis* (Currie), and *yavapai* (Currie).

Distribution: West of the Mississippi River, north to about 45° North latitude and south to temperate Mexico.

Discussion: The broad posterior area of the hindwing (Fig. 14) is the key character for the group, which is duplicated only in *Clathroneuria coquilletti* and *Brachynemurus sackeni* in the New World. *Clathroneuria coquilletti* is easily distinguished by the long femoral sense hair, medial lobe of the male ectoproct, and male genitalia. *Scotoleon expansus* tends to have this area narrower, especially in smaller specimens. There is considerable differentiation of the labial palps in this genus and these differences are usually constant at the specific level. *S. expansus* and *S. yavapai* are rather aberrant species, especially in the modification of the male genitalia.

The loss of the pilula axillaris, broadened hindwing posterior area, and the presence of modified tergal setae on the male abdomen are generic synapomorphies. This is probably one of the most actively evolving genera in the Brachyneumurini judging by the difficulty of separating some species and the presence of polytypic species. The wing venation, especially the broadened hindwing posterior area, is similar to that found in the Old World Myrmecaelurini. Larvae have been identified for most species and are different from other Brachynemurini (except *Atricholeon* and *Dejuna*) in lacking submedial teeth on sternite VIII.

13. *Venezuleon* Stange, new genus (Figs. 21, 47, 48)

Type Species: *Venezuleon guaricus* Stange, by present designation.

Adult Description: Frons with setae; antenna same length in both sexes, about 30 flagellomeres; antennal fossae separated by more than twice width of pedicel; pronotum about twice as wide as long; profemur without clavate setae or setal comb; femoral sense hair absent; tibial spurs present; pretarsal claws shorter than hind basitarsus and one-half distal tarsomere, about same length as tibial spurs; mesonotum without blade-like setae; scutelli with well developed white setae posteriorly; hindwing as long as forewing, in repose wing apices nearly

coincide; pilula axillaris well developed; weak anterior banksian line in both wings; forewing costal area simple; posterior area of hindwing narrower than presectoral area before radial sector; forewing vein CuP + 1A only runs along posterior fork of CuA for a short distance (in contrast to *Ameromyia*), interconnected by about 4 crossveins; hindwing CuA runs along posterior fork of medial fork for a short distance; radial sector originates a little basad of medial fork in hindwing, about 3-4 presectoral crossveins; postventral lobe of male ectoproct moderately developed, less than twice as long as median diameter; sternite IX much wider than long, not produced medially; male genitalia highly modified, gonarcus broadly expanded, plate-like laterally with lateral tooth; mediuncus arched, bifurcate ventrally; parameres simple, elongate rods; genital sac with many strongly clavate setae; female genitalia with pregenital plate membranous; gonapophyseal plate elongate; posterior gonapophysis at least 3X longer than median diameter; ectoproct and lateral gonapophysis with strongly flattened digging setae; latter partially fused.

Larval Description (based on *guaricus*): Mandible as long as head capsule, distance between teeth more than that between base of mandible and basal tooth; head capsule as wide as long (measured ventrally); dorsal and ventral surface of head capsule with dolichasters; mesothoracic spiracle borne on tubercle that is longer than basal width; abdominal tergites without thickened setae or thread-like setae; abdominal spiracles not enlarged; sternite VIII with submedian teeth that are longer than basal widths.

Distribution: Venezuela.

Discussion: This genus appears to be closely related to *Ameromyia*, especially in regards to the similar male genitalia, female terminalia (lateral gonapophyses at least partially fused), widely separated antennal fossae, and frontal setae. Leg structure and wing venation offer significant differences. The pretarsal claws are weakly developed and the femoral sense hair is absent in *Venezueleon*. Forewing vein CuP + 1A only parallels posterior fork of CuA for a short distance in contrast to *Ameromyia*. The larva resembles those of the *Ameromyia modesta* Group in having mesothoracic spiracle borne on an elongate tubercle, the relatively wider head capsule, and the presence of dolichasters on the ventral surface of the head

capsule. The extreme width of the head capsule is autapomorphic for the genus and probably is associated with its microhabitat. The absence of thread-like setae on the abdominal tergites may be a larval character from the *A. modesta* Group. There are four undescribed species, one of which is described below.

Venezueleon guaricus Stange, new species

Holotype male: Rio Orituco, 15 km S Calabozo, Guarico, Venezuela, February 27, 1988, R. B. Miller & L. A. Stange (FSCA).

Adult Description: Length of body 32 mm; length of forewing 20 mm, greatest width 5 mm. General coloration pale brown with considerable yellow orange wing suffusion. Head mostly pale brown with darker brown vertex, anterior row of vertex scars most prominent; frons with transverse light brown stripe near middle; antenna nearly all pale brown with darker brown on pedicel, extreme base of flagellomeres (especially dorsally) and apical spine; pronotum pale brown with median whitish stripe laterad of which somewhat darker brown than laterally, setal bases darker brown; mesoscutum and metascutum pale brown with darker brown sublaterally, scutelli with faint sublateral dark stripe; pleura pale brown, dark brown stripe on upper episternum; legs pale brown except darker brown ventrally; femora and tibiae with dark brown stripe on mesal margin; tarsi dark brown ventrally; wings with veins mostly pale brown, membrane suffused with yellow orange; forewing with rhegmal mark along posterior fork of CuA near hind margin, several crossveins especially in radial sector, near cubital fork, and crossveins at margins along costal area and posterior area; posterior vein white.

Frons with setae; pronotum with outstanding white bristles along anterior, posterior, and lateral margins; a few medially; scutelli with outstanding white bristles posteriorly; mesoscutum with numerous white bristles; legs without femoral sense hair and nearly without outstanding setae, a few on femora and tibiae are shorter than diameter at point of origin; mesocoxa and metacoxa with a few white bristles posteriorly; male abdomen with long pale brown setae; those on sternites I-V twice as long as those on corresponding tergites, posteriorly setae become of equal lengths; postventral lobe of

male ectoproct with about 4 dark brown setae, mostly apically.

Greatest ocular width about two-thirds interocular distance; antenna with 30 flagellomeres; distal palpomere of labium not swollen, sensory opening nearly circular, located near middle and occupying most of dorsal surface; pronotum twice as wide as long; proleg and mesoleg about equal in length, metaleg the longest; basitarsomere of metaleg about 3X longer than diameter, somewhat longer than that of mesoleg; distal tarsomere about as long as tarsomeres 2-4 together; pretarsal claw about as long as hind basitarsus, about as long as tibial spurs; wings narrow, somewhat sinuate near base, apex asymmetrical; forewing costal cells longer than high; forewing with 3 presectoral crossveins; CuP + 1A runs along posterior fork of CuA short distance, interconnected by 3 crossveins; hindwing radial sector originates at about level of medial fork, 4 presectoral crossveins; hindwing posterior area narrower than prefork area; CuA runs along posterior fork of MP₂ for short distance, interconnected by 4 crossveins. Abdomen much longer than wings; segment VIII about 3X longer than high; male ectoproct with postventral lobe about as long as greatest diameter; male genitalia as in Figure 48.

Female: About as described for male. Abdomen shorter than wings; setae on basal abdominal sternites about equal to those on basal abdominal tergites; pregenital plate (Fig. 21) membranous but median tubercle present; posterior gonapophysis about 3X longer than wide, without digging setae; digging setae on ectoproct and lateral gonapophysis well developed; gonapophyseal plate small.

Paratypes: 9 males, 9 females, same data as types (CAS, USNM, FSCA, Miller collection); 3 males, 1 female, 12 km S Calabozo, Guarico, Venezuela, Feb. 6-12, 1969, P. Spangler (FSCA; USNM).

Discussion: There is some variation in this species at the type locality. The degree of wing suffusion varies and smaller specimens appear to have a relatively shorter and broader wing. There are evidently 3 additional undescribed species, all known from single specimens from Venezuela. They differ in wing shape and coloration. Larvae were discovered at the type locality. They live in shallow sand, anchored to bedrock. Two adults were reared to confirm the association.

Gnopholeontini Stange, New Tribe

Adult Description: Labial palps short, palpimacula not extending to apex; metafemur without sensory hair; pretarsal claws not toothed nor strongly bent near base; tibial spurs present or absent; forewing vein CuP originates distad of crossvein m-cu; forewing vein 2A runs in a fairly even curve toward 3A; pilula axillaris present, usually well developed; hindwing vein CuA runs close to hind margin, ends near medial fork; hindwing radial sector originates before medial fork, 2 or 3 presectoral crossveins; male abdomen without hair pencils or postventral lobe; male paramere plate-like; female anterior gonapophysis plate-like or membranous; posterior gonapophysis inflated; pregenital plate with tooth; gonapophyseal plate large; female ectoproct with digging setae.

Larval Description: Mandibular bases close together, separated by about basal width of mandible; mandible with 3 teeth, middle tooth closer to distal tooth than basal tooth; distal tooth not shorter than middle tooth; abdomen without dolichasters or tufted setae along median area, sometimes with lateral scoli.

Discussion: This tribe is characteristic of the Sonoran Region. Larvae are either free living (*Tytholeon*), live in protected areas (rock overhangs) (*Menkeleon*) or live on rocks or tree trunks (*Gnopholeon*). The larvae are unknown for *Maracandula*, but evidence suggests they are associated with rocks. The principle synapomorphy of the genera in this tribe is the close approximation of the larval mandibles. The inflated posterior gonapophyses (Figs. 31, 32) function as egg handlers rather than egg coaters according to Miller (1990). Even more modified posterior gonapophyses are found in the Lemolemini. Some species (especially *Maracandula*) are afternoon fliers.

Key to the genera of Gnopholeontini

Adults

1. Tibial spurs present (Fig. 39).....
..... *Gnopholeon* Stange
Tibial spurs absent (Fig. 40) 2
2. Wings narrow with sparse venation; male ectoproct produced mesally below (Fig. 50); posterior gonapophysis of female subcylindrical; prege-

- nital plate very large (Fig. 30)
 *Tytholeon* Adams
 Wings broad with denser venation; male ectoproct
 not produced mesally; posterior gonapophysis
 of female greatly swollen, pregenital plate small
 (Figs. 31, 32) 3
3. Antennal flagellomere 3 at least 1.5X longer than
 wide (Fig. 36); cubital fork of forewing and
 medial fork of hindwing arise near middle of
 wing; pretarsal claws more than 2X longer than
 greatest diameter of apical tarsomere; female
 lateral gonapophyses fused (Fig. 31)
 *Maracandula* Currie
 Antennal flagellomere 3 about as long as wide;
 cubital fork of forewing and medial fork of
 hindwing arise well before middle of wing;
 pretarsal claws not much longer than greatest
 diameter of apical tarsomere (Fig. 40); female
 lateral gonapophyses not fused
 *Menkeleon* Stange

Larvae

1. Mesothoracic sternum with specialized patch of
 lanceolate setae at middle (Fig. 71); labial pal-
 pus very long, distal palpomere beyond sensory
 area more than 5X longer than wide; head
 capsule subquadrate, posterolateral corners
 produced laterally (Fig. 71); live in open sand
 *Tytholeon* Adams
 Metathoracic sternum without specialized patch
 of setae; labial palpus short to moderately long,
 distal palpomere less than 3X longer than wide
 beyond sensory area; head capsule various, but
 not much produced at posterolateral corners..
 2
2. Abdomen with scoli (except 1st instar); head
 greatly produced at anterolateral areas which
 bear stemmatal tubercles, with long setae which
 camouflage mandible in trap position (Fig. 68);
 maximum jaw gape ca. 260°; mandibular teeth
 about equidistant; on tree bark or bare rock
 faces *Gnopholeon* Stange
 Abdomen without scoli; head not greatly pro-
 duced and without long lateral setae; maximum
 jaw gape 200°; mandibular dentition with middle
 tooth much closer to distal tooth than basal
 tooth; under rock overhangs
 *Menkeleon* Stange

13. *Gnopholeon* Stange (Figs. 15, 32, 39, 68-69)

Gnopholeon Stange, 1970. Univ. Calif. Pub. Ent. 55:148.

Type Species: *Gnopholeon zapotecus* Stange, by
 original designation.

Adult Description: Legs short and relatively
 stocky, profemur less than 1.5X longer than procoxa;
 hind basitarsus much shorter than distal tarsomere;
 femoral sense hair elongate, one on proleg and
 mesoleg; pretarsal claws and tibial spurs well de-
 veloped; wings narrow with sparse venation;
 banksian lines absent; hypostigmatic cell without
 crossveins; posterior area of hindwing narrow, CuA
 bends to hind margin near medial fork; pilula
 axillaris well developed with setae covering most of
 dorsal surface of knob; male genitalia with simple
 gonarcus, free parameres; male ectoproct simple,
 postventral lobe weakly developed at most; female
 terminalia with posterior gonapophysis swollen
 thumblike; pregenital plate narrow with median
 tooth; gonapophyseal plate expansive.

Larval Description (based on *barberi*): Head
 capsule greatly modified, much wider than long,
 greatly produced anterolaterally into a pair of ro-
 bust stemmatal tubercles which bear long setae
 which camouflage mandibles in trap position; man-
 dible elongate, narrow, with three closely spaced,
 equidistant teeth far removed from base; mesotho-
 racic spiracle not borne on tubercle; meso- and
 metathoracic as well as abdominal segments I-VIII
 each with a bilaterally symmetrical pair of large
 scoli; pretarsal claws of hindleg no longer than
 those of mesoleg; submedian teeth on sternite VIII
 longer than basal widths.

Included Species: *barberi* (Currie), *delicatulus*
 (Currie), and *zapotecus* Stange.

Distribution: Deserts of southwestern United
 States to southern Mexico.

Discussion: The female genitalia provide funda-
 mental differences from all other genera in the
 tribe except for *Menkeleon*. The small pregenital
 plate is a notable difference from *Tytholeon*; and
 the separate lateral gonapophyses, smaller poste-
 rior gonapophysis, stockier legs with one elongate
 femoral sense hair, sparser wing venation, and well
 developed tibial spurs are important differences
 from *Maracandula*. The well developed tibial spurs
 are a key diagnostic trait readily differentiating
Gnopholeon from all other genera in the tribe.

This may be a paraphyletic genus since the two
 species groups differ in characters that are of ge-
 neric importance in the related Brachynemurini.
 The *G. barberi* Group have forefemoral clavate
 setae (absent in *G. delicatulus* Group) whereas the

lack of digging setae on the female ectoproct of the *G. delicatulus* Group is an apomorphy of that group. The pretarsal claws are also larger than in the *G. barberi* Group. This taxonomic decision is being deferred until the larval stage of *G. delicatulus* is known. The larva of the *G. barberi* Group is one of the most bizarre larval types known in the family Myrmeleontidae and resembles in some ways the larvae of Ascalaphidae. The hind pretarsal claws are not enlarged as in other antlions and the mandibular bases are the most approximated of any known antlion larva. The head capsule is highly modified, with the mandibles capable of a gape more than 260° which is a strong apomorphy. The abdominal scoli are well developed in later instars. The larva was reared through the 3 instars from an egg laid by a captive female. It is suspected that the larva lives on tree trunks due to its camouflage and structure.

14. *Maracandula* Currie (Figs. 31, 36, 59)

Maracandula Currie, 1901. Proc. ent. Soc. Wash. 4:436.

Type species: *Myrmeleon pygmaeus* Hagen, by original designation. Banks 1927. Bull. Mus. Comp. Zool. 68:58 (further description). Stange 1970. Univ. Calif. Publ. Ent. 55:154 (further description).

=*Microleon* Banks, 1901. Trans. Amer. ent. Soc. 27:365.

Type species: *Microleon apicalis* Banks, by original designation. Preoccupied by *Microleon* Butler, 1885.

=*Mimoleon*, Banks 1913. Trans. Amer. ent. Soc. 39:226.
New name for *Microleon* Banks, 1901.

Adult Description: Antennae with flagellomeres 2-4 much longer than wide; legs moderately long and slender, profemur more than 1.5X longer than procoxa; hind basitarsus shorter or longer than distal tarsomere; femoral sense hair small and hardly distinguishable from surrounding bristles, one each on proleg and mesoleg; pretarsal claws weakly developed; tibial spurs absent; wings broad with dense venation; banksian lines absent; hypostigmatic cell with or without several crossveins; posterior area of hindwing narrow, CuA bends to hind margin near medial fork; pilula axillaris well developed with setae covering most of dorsal surface of knob; male genitalia with rather simple gonarcus, free parameres; eversible sac present laterally and ventral to male genitalia; mesal margin of male ectoproct with short, rather

truncate process near origin of weakly developed postventral lobe, somewhat produced ventrally; female terminalia with posterior gonapophysis extremely enlarged and swollen; lateral gonapophyses fused; pregenital plate narrow with median tooth; gonapophyseal plate expansive.

Larval Description: Unknown.

Included Species: *apicalis* (Banks) and *pygmaeus* (Hagen).

Distribution: Central and Southern Mexican highlands.

Discussion: This genus exhibits a number of unusual characters. The female genitalia are highly specialized with the posterior gonapophysis extremely enlarged and swollen and the lateral gonapophyses fused. The presence of several crossveins in the hypostigmatic cell in the described species is a feature not found elsewhere in the Myrmeleontidae of the Western Hemisphere, although some individuals of *Menkeleon bellula* approach this condition. Also of unusual interest is the extreme reduction of the eyes and highly modified antenna in the described species (autapomorphies). The closest relative is the genus *Menkeleon*. The female genitalia of *Maracandula* appear more specialized than in *Menkeleon* with the lateral gonapophyses fused and the posterior gonapophysis greatly enlarged. Also, the subapically broadened wings of *Maracandula* are distinctive. However, in 2 undescribed species of *Maracandula*; leg and wing characters are more similar to *Menkeleon*. From the spurless genus *Tyttholeon*, the small pregenital plate, differently formed male ectoproct, and wing venation offer important differences. There are two described species and several undescribed ones. The adults fly in the afternoon.

15. *Menkeleon* Stange 1970:154 (Figs. 40, 70)

Menkeleon Stange, 1970. Univ. Calif. Pub. Ent. 55:

Type Species: *Maracandula bellula* Banks, by original designation.

Adult Description: Antennae with flagellomeres 2-4 about as long as wide; legs moderately long and slender, profemur more than 1.5X longer than procoxa; hind basitarsus longer than distal tarsomere; two subequal, rather long femoral sense

hairs on proleg and mesoleg; wings broad with rather dense venation, hypostigmatic cell usually without crossveins; banksian lines absent; posterior area of hindwing narrow, CuA bends to hind margin near medial fork; pilula axillaris small with setae restricted to apical margin of knob; male genitalia with rather simple gonarcus, free parameres; male ectoproct rather simple, somewhat produced ventrally, postventral lobe weakly developed; female terminalia with posterior gonapophysis swollen thumblike; lateral gonapophyses separate; pregenital plate narrow with median tooth; gonapophyseal plate expansive.

Larval Description (based on *bellulus*): Head capsule wider than long, weakly produced posterolaterally; labial palpus moderately long, distal palpomere less than 3X longer than wide beyond sensory area; mesothoracic spiracle borne on tubercle; mesosternum without specialized setal patch at middle; abdomen without scoli.

Included Species: Only *bellulus* (Banks).

Distribution: Southwestern United States, northern Mexico.

Discussion: The female terminalia of *Menkeleon* are quite similar to *Gnopholeon* but *Menkeleon* lacks tibial spurs. Superficially, the species of *Menkeleon* resembles those of *Maracandula* but generic distinctions are detailed in the key. The presence of 2 short femoral sense hairs is autapomorphic. The larva was found under an overhanging rock.

16. *Tythholeon* Adams (Figs. 30, 50, 57, 71)

Tythholeon Adams, 1957. Psyche 63:106. **Type Species:** *Tythholeon puerilis* Adams, by original designation. Taxonomy: Stange 1970:157.

Adult Description: Antenna with 20-25 flagellomeres, flagellomere 1 longer than wide, about one-half length of pedicel and subequal to flagellomere 2; greatest ocular width about one-half interocular distance; legs rather short and stocky, profemur about 1.5 times longer than procoxa; hindleg a little longer than proleg; profemur without clavate setae; profemoral sense hair much less than one-half length of profemur, equal to that of midfemur; tibial spurs absent; pretarsal claws

shorter than hind basitarsus which is either longer or shorter than distal tarsomere; wings slender, with sparse venation; hypostigmatic cell without crossveins; banksian lines absent; hindwing posterior area narrow, CuA bends to hind margin before medial fork; pilula axillaris moderately well developed with setae concentrated toward distal margin of knob; male genitalia with simple gonarcus, free parameres; male ectoproct produced mesally below, no postventral lobe; female posterior gonapophysis subcylindrical, lateral gonapophysis separate; pregenital plate much enlarged with a prominent median process posteriorly; gonapophyseal plate large.

Larval Description (based on *puerilis*): Head capsule wider than long, produced posterolaterally, with dolichasters; labial palpus extraordinarily elongate; distal palpomere beyond sensory area more than 5x longer than wide; mesothoracic spiracle borne on elongate tubercle; mesothoracic sternum with specialized lanceolate setae at middle; pretarsal claws of hindleg about 2x longer than that of mesoleg; abdomen without scoli; submedian tooth of sternite VIII longer than basal width.

Included Species: *puerilis* Adams.

Distribution: Mojave-Colorado Desert; Great Basin; Baja California.

Discussion: The highly modified female pregenital plate (Fig. 30) and shape of the male ectoproct (Fig. 71) are autapomorphic. The larva (Fig. 65) is also very distinctive with the development of lanceolate setae on the metasternum (autapomorphic). Other distinctive characters are the loss of tibial spurs (present in *Gnopholeon*) and narrow wings (broad wings in *Maracandula* and *Menkeleon*). The larva lives in the sand. One undescribed species is found in southern Baja California.

Lemolemini Stange, new tribe

Adult Description: Labial palps short, sensory area oval; metafemur without sensory hair; pretarsal claws not toothed nor strongly bent near base; tibial spurs present, sometimes shorter in male; forewing vein CuP originates distad of base; forewing vein 2A runs a fairly even curve toward 3A; pilula axillaris present; hindwing as long as forewing, in repose apex of hindwing extends beyond that of forewing (except *Galapagoleon*);

hindwing vein CuA runs close to hind margin, ends near medial fork; hindwing radial sector originates well before medial fork, usually 2 presectoral crossveins; abdomen without hair pencils, shorter than wings, about same length in both sexes; male ectoproct without postventral lobe; male paramere plate-like; female anterior gonapophysis plate-like or membranous, posterior gonapophysis highly modified, either swollen or strongly curved; gonapophyseal plate usually very large (except *Elicura* and *Lemolemus*); female ectoproct without digging setae.

Larval Description: Mandibular bases far apart, separated by much more than basal width of mandible; mandible with 3 parallel teeth, middle tooth closer to distal tooth than basal tooth, distal tooth is longer than middle tooth; basal tooth distal to midpoint of mandible; abdominal segments with dolichasters or tufted setae along midline, sometimes with lateral scoli; sternite VIII with submedian teeth.

Discussion: This tribe is apomorphically defined by the specialized setae found medially on the abdominal tergites of the larva. The adults have one apomorphic character, the lack of digging setae on the female ectoproct. This is evidently a relict group without close relatives. Oddly, although some larvae (*Lemolemus*, *Sical*, *Elicura*) live in loose soil under rock overhangs or near tree bases, none has invaded the sand dune habitats which abound in Central Chile. This tribe is most diverse in Chile where 5 of the 7 genera occur. Three genera, *Elicura*, *Lemolemus*, and *Sical* are closely related, but the other four genera are isolated. *Elicura* reaches Argentina and southern Brazil. *Ecuaeon*, found in western Ecuador, is assigned to the tribe based on a presumed larva which agrees with Lemolemini and adult characters. *Galapagoleon* is unknown in the larval stage and is tentatively referred to the Lemolemini since the female terminalia are similar to *Ecuaeon*.

Key to genera of Lemolemini

Adults

1. Pretarsal claws shorter than length of proleg basitarsus; profemoral sense hair about 1/4 length of femur; antennal fossae separated by more than width of pedicel; female posterior gonapophysis longer than height of ectoproct, not curved (Figs. 25, 27) 2

2. Forewing costal area biareolate in part; hindwing shorter than forewing, in repose apices of wings nearly coincide; male ectoproct with large ventral process; female gonapophysis evenly swollen for complete length, with apical scraping setae (Fig. 25) *Jaffuelia*
 3. Male ectoproct with indication of postventral lobe; female posterior gonapophysis longer than height of ectoproct, strongly curved mesally (Fig. 23, 34); Galapagos Islands; southwestern Ecuador 4
 4. Forewing posterior area highest near cubital fork; female tergite VII with subapical row of prominent setae (Fig. 33) ; male ectoproct mesally emarginate ventrally (Fig. 35); Western Ecuador *Ecuaeon*
 5. Profemur with long white bristles along exterior face; forewing costal area broad, area above cubital fork nearly 3X as high as subcostal area, often triareolate; mesofemoral sense hair about 1/2 length of femur; female terminalia with anterior gonapophysis plate-like (Fig. 24); pregenital plate much longer than wide; southern Chile, Argentina; Uruguay; southern Brazil *Elicura*
- Forewing costal area with single series of cells; hindwing as long as forewing, in repose apex of hindwing extends beyond that of forewing; male ectoproct without ventral process; female gonapophysis swollen toward apex, without scraping setae (Fig. 27) *Neulatus*
- Male ectoproct without indication of postventral lobe; female posterior gonapophysis shorter than height of ectoproct, not strongly curved mesally (Figs. 24, 26); Central Chile; Argentina; Uruguay; southern Brazil 5
- Forewing posterior area highest near end of vein 2A; female tergite VII without subapical row of prominent setae; male ectoproct not emarginate mesally; Galapagos Islands *Galapagoleon*

- with anterior gonapophysis lobe-like (Fig. 26); pregenital plate wider than long; Central Chile 6
6. Basitarsus of metaleg less than 3X longer than wide; forewing costal area with few, if any, interconnected crossveins in basal half; pregenital plate large, without median tooth .. *Sical*
Basitarsus of metaleg at least 4X longer than wide; forewing costal area with most crossveins interconnected; pregenital plate small, with median tooth *Lemolemus*

Larvae

(*Ecualeon* and *Galapagoleon* unknown)

1. Abdominal segments I-VII with well developed scoli, at least longer than wide (Figs. 62, 63); abdomen without median row of tufted black setae but with roseate, squat dolichasters; pretarsal claws with basal tooth 2
Abdominal segments I-VII without scoli, or if short scoli present, then wider than long; abdomen with median row of tufted black setae (except first instar), without roseate dolichasters; pretarsal claws without basal tooth 3
2. Abdominal scoli at least 3X longer than wide, tapered to apex, without dolichasters (Fig. 62); head longer than wide; live in *Puya* plants
..... *Neulatus* Navás
Abdominal scoli less than 2X longer than wide, broadened apically, with dolichasters (Fig. 63); head wider than long; live on boulders
..... *Jaffuelia* Navás
3. Abdominal segments I-VII with weak scoli; head capsule and scoli with abundant silky white, hairlike setae *Sical* Navás
Abdominal segments I-VII without scoli; head capsule and scoli without silky, white, hairlike setae 4
4. Mandible pale with numerous dark brown spots; anterior scolus of mesothorax 2X longer than wide *Elicura* Navás
Mandible pale with dark brown areas mostly at base; anterior scolus of mesothorax 1.5X longer than wide *Lemolemus* Navás

17. *Ecualeon* Stange, New Genus (Figs. 33-35)

Type species: *Ecualeon ovispargus* Stange, by present designation.

Adult Description: Antennal fossae separated by about width of scape; distal palpomere of labium moderately swollen; profemur without white bristles on exterior face except 1 or 2 subapical ones; procoxa with 2 white bristles anteriorly and posteriorly, setae more than one-half coxal diameter; profemoral sense hair about one-half length of profemur, about as long as that of mesofemur; pretarsal claws moderately developed, longer than pro-basitarsus but shorter than tibial spurs which are longer than meta-basitarsus; tibial spurs of same length in both sexes; forewing costal area biareolate in about distal one-fourth to one-third; forewing radial sector arises well basad of cubital fork, in contrast to position of hindwing radial sector which arises only little basad of medial fork; hindwing usually with 4 presectoral crossveins; forewing posterior area highest near cubital fork; anterior banksian line absent; hindwing nearly as long as forewing, in repose hindwing apex extends somewhat beyond that of forewing; male sternite IX large, much narrowed posteriorly; male abdomen much longer than wings, segment VIII at least 4X longer than high; scale-like setae on segments III-V; male ectoproct bilobed ventrally on mesal margin (Fig. 35), postventral lobes indicated; gonarcus nearly transverse, mediuncus large, smooth, except doubly ridged apically, paramere a flat sclerite, with lateral process (Fig. 35); female with large, transverse pregenital plate with minute medial tooth; gonapophyseal plate large and expansive; posterior gonapophysis swollen and curved subapically; anterior gonapophysis swollen, transverse, with many elongate setae; ectoproct with digging setae, those on lateral gonapophysis moderately developed; sternite VII not produced medially; tergite IX of female not produced ventrally; tergite VII of female with subapical row of large, curved setae (Fig. 33).

Distribution: Southwest Ecuador

Discussion: This genus is provisionally assigned to the Lemolemini. It appears related to *Galapagoleon* especially in regards to the curved posterior gonapophysis of the female terminalia. The structure of the female abdomen suggests that this genus may throw eggs similar to that observed in *Psammoleon* which has similar female terminalia. The presence of the prominent row of setae on tergite VII (Fig. 33) may be a significant sign of such behavior. Another significant character of this genus is the broadening of the posterior area near the cubital fork. Quite unusual and unique, at least

among New World antlions, is the development of large, scale-like setae on male abdominal segments III-V. The male ectoproct (Fig. 35) is emarginate ventrally which is unique in the tribe.

Ecualeon ovispargus Stange, New Species

Holotype male: 7 km. S. Piñas, Province El Oro, Ecuador, July 7, 1989, R. Miller & L. Stange (Florida State Collection of Arthropods).

Adult Description: Length of body 34 mm; length of forewing 22 mm, greatest width 6 mm; general coloration yellowish brown, wing membrane transparent except small brownish suffusion at nearly every vein juncture. Head color variable, from pale to dark brown; anterior row of vertex scars most prominent, dark brown lateral scar and smaller submedian dark brown scar; middle row reduced to submedian dark brown area; posterior row with prominent dark brown lateral scar, middle scar lighter brown; clypeus and labium mostly yellowish brown, gena mostly dark brown, prominent dark brown spot beneath antennal fossa; postgena nearly completely shiny dark brown; palpi dark brown except pale apically except distal palpomeres; antenna nearly all brown, scape pale brown posteriorly and less so anteriorly; pedicel and base of flagellomere 1 dark brown; pronotum mostly pale brown medially, darker brown laterally with numerous dark brown spots at setal bases; mesonotum and metanotum similar to pronotum with pale brown medially, dark brown laterally; scutelli mostly pale brown; mesopleuron dark brown anteriorly, mostly pale brown posteriorly; metapleuron mostly pale brown with scattered dark brown areas; coxae and mera mostly pale brown, meso- and meta-coxae darker brown posteriorly; femora and tibiae pale brown with dark brown spots at setal bases and apically, especially profemur and mesofemur; tarsi pale brown with dark brown mostly on tarsomeres 4 and 5 and apex of distal tarsomere; tibial spurs and claws reddish brown, lighter distally; forewing and hindwing nearly equally colored; wing veins pale brown with extensive dark brown sections near vein and crossvein junctures; stigma pale white preceded by relatively large dark brown spot; small dark brown rhemal spot; abdomen brown, pale brown areas mostly at base and less at middle of both tergites and sternites.

Frons without setae; clypeus with transverse row of 4 long, black setae; scattered decumbent setae on vertex; labium with many long black setae decreasing in length distally; pronotum with long (some one-third length of pronotal width) setae on margins, shorter ones on middle, black ones mostly lateral, white ones medial; prescutum with 3-4 black or white setae in a row, mesonotum with 3-5 white setae in a row near middle; mesoscutellum with sublateral white seta near posterior margin (2 pairs in some paratypes); procoxa with 2 white bristles anteriorly and posteriorly, posterior ones somewhat longer than coxal width, anterior ones shorter; profemur without bristles on exterior margin except a few subapical ones; closing face of all femora and tibiae and exterior face of tibiae with many elongate bristles that are mostly twice as long as femur or tibia, black bristles on exterior face; profemoral sense hair about as long as that of mesofemur, about one-half length of femur; wing setae very long and ubiquitous, more than 6X longer than vein diameter; abdomen with long and ubiquitous setae; tergites II-V and sternites III-V with numerous brown, scale-like setae, some of which on sternites are 3X as long as on tergites; setae mostly at middle of tergites and sternites.

Greatest ocular width nearly as great as interocular distance; antenna with 30 flagellomeres; flagellomere 1-13 about 1.5X longer than wide, abruptly broadening beyond so that flagellomere 20 about 3X broader than long; distal palpomere of labium somewhat swollen, circular sensory area a little beyond midpoint of palpomere; legs moderately long, mesoleg about 0.5X longer than proleg but shorter than hindleg; basitarsus of proleg and mesoleg about 3X longer than diameter, about one-half length of distal tarsomere; hind basitarsus about 4X longer than diameter; tibial spurs reach nearly to apex of tarsomere 2 of pro- and mesotarsus, and somewhat beyond apex of metatarsus; pretarsal claws shorter than tibial spurs, about as long as pro-basitarsus; hindwing nearly as long as forewing, in repose apex of hindwing projects beyond that of forewing; wings all about same shape but hindwing narrower; forewing costal area biareolate in distal one-half, cells higher than wide in basal one-half; forewing with radial sector arising well before cubital fork, 5-6 presectoral crossveins; CuP + 1A runs along posterior fork of CuA for short distance, interconnected by 3 crossveins; posterior area highest near distal end; hindwing radial sector areas somewhat before medial fork, 4-5 presectoral crossveins; hindwing pos-

terior area narrower than prefork area, highest near distal end; CuA runs to hind margin just before medial fork; pilula axillaris large; abdomen much longer than wings; segment VIII about 4X longer than high; male ectoproct with postventral lobe weakly indicated, bifurcate mesally (Fig. 35); male genitalia (Fig. 35) with gonarcus arched but smaller than mediuncus which is a concave plate doubly ridged apically; paramere flat plate, laterally produced.

Female: About as described for male. Abdomen shorter than wings; scale-like setae absent; tergite VII with posterior row of long, posteriorly directed bristles; terminalia (Fig. 33) with posterior gonapophysis swollen, strongly curved mesally, about 2X longer than median diameter; gonapophyseal plate expansive; anterior gonapophysis swollen, beset with setae; lateral gonapophysis elongate, digging setae about as long as width; ectoproct with row of 4 dorsally directed bristles; pregenital plate sclerotized, transverse, with small median tubercle.

Paratypes: 3 males, 20 females, same date as holotype (MC, USNM, Quito, SC, FSCA).

Biology: Adults were found flying among 5 foot tall grasses or bushes, usually in the shade. When disturbed they fell to the base of the grass where detection was difficult. None was attracted to lights but one was found by jack lighting. An unidentified larva collected under a rock overhang in Ecuador may be this species. It has specialized setae along middle of abdomen and abdominal scoli.

18. *Elicura* Navás (Fig. 24)

Elicura Navás, 1911. Rev. chilena Hist. nat. 15:126.

Type Species: *Elicura litigator* Navás, by original designation.

=*Plater* Navás, 1919. Rev. Acad. civ. Madrid 17:297. New synonym. **Type Species:** *Plater iniquus* Navás, by original designation.

=*Bridarollus* Navás, 1933. Rev. Acad. Cienc. Zaragoza 16:90. New synonym. **Type Species:** *Bridarollus solers* Navás, by original designation.

Adult Description: Antennal fossae separated by about width of pedicel; profemur with row of white bristles on exterior face; profemoral and mesofemoral sense hair more than one-half length of femur; pretarsal claws longer than probasitarsus; tibial spurs of same length in both sexes; forewing costal area broad, about 3X higher than subcostal area above cubital fork, usually triareolate; anterior banksian line weakly developed; hindwing about same length as forewing, in repose apex of hindwing extends beyond that of forewing; male ectoproct simple, without lobes or processes; male sternite IX much wider than long, weakly produced medially; male genitalia with arched gonarcus, mediuncus short, not ridged; paramere longer than wide; much narrower at mediuncus; female terminalia with sternite VII not produced; tergite IX not produced ventrally; pregenital plate sclerotized, longer than wide, with medial tubercle; posterior gonapophysis swollen, much shorter than height of ectoproct; ectoproct and lateral gonapophysis without digging setae; anterior gonapophysis plate-like.

Larval Description (based on *litigator*): Head capsule longer than wide, with dolichasters; mandible pale with dark brown areas; anterior mesothoracic scoli 2X longer than wide, with pale dolichasters; abdominal scoli absent; abdomen with median row of tufted black setae; pretarsal claws without basal tooth; mesothoracic spiracle borne on tubercle that is longer than wide; abdominal spiracles enlarged, borne on tubercles.

Included Species: *iniquus* (Navás), *justus* (Navás), *litigator* Navás.

Distribution: Southern Chile, Argentina; Uruguay; southern Brazil.

Discussion: Stange (1967) placed some of the species of *Elicura* in *Lemolemus* which this genus closely resembles. One notable difference between *Elicura* and *Lemolemus* is that the anterior gonapophysis is lobe-like in *Lemolemus*. The forewing costal area is very broad in *Elicura* and provides one character to separate it from all others in the tribe. Larvae of *E. litigator* were found in many habitats such as rock overhangs, tree holes, and at bases of trees and resemble Nemoleontini and Dendroleontini in mandibular dentition. The dark spotting of the mandible is distinctive in the tribe.

19. *Jaffuelia* Navás (Fig. 25, 63)

Jaffuelia Navás, 1918. Bol. Soc. aragonesa 17:217.

Type species: *Jaffuelia chilensis* Navás, by original designation.

Adult Description: Antennal fossae separated by more than width of pedicel; distal palpomere of labium slender; profemoral sense hair short, less than one-fourth length of femur, equal to that of mesofemur; pretarsal claws shorter than metabasitarsus, about same length as tibial spurs; tibial spurs the same length in both sexes; forewing costal area mostly biareolate; forewing radial sector arises well basad of cubital fork about equivalent to the distance between radial sector and medial fork in hindwing; anterior banksian line weakly developed; hindwing shorter than forewing, in repose wing apices nearly coincide, male sternite IX transverse; male ectoproct with medial lobe ventrally; male genitalia with arched gonarcus, short mediuncus, parameres plate-like; female terminalia with posterior gonapophysis evenly swollen for complete length; with scraping setae; ectoproct and lateral gonapophysis without digging setae; pregenital plate sclerotized with median ridge; sternite VII not produced medially; tergite IX not produced ventrally; anterior gonapophysis plate-like.

Larval Description (based on *chilensis*): Head wider than long, with many squat, dark dolichasters on dorsal surface similar to those on rest of dorsum; thoracic and abdominal scoli well developed although less than 2X longer than wide, with many dolichasters; abdomen with median row of clumped dolichasters; pretarsal claws with basal tooth; mesothoracic spiracle borne on tubercle that is wider than long; abdominal spiracles enlarged, but not much raised.

Included Species: *chilensis* Navás and *porterina* Navás.

Distribution: Central Chile.

Discussion: This genus has several autapomorphic characters in the tribe. The shape of the male ectoproct which has a mesal process ventrally is distinctive and the long, evenly swollen female posterior gonapophysis with scraping setae (Fig. 25) is diagnostic for that sex. The biareolate forewing costal area is duplicated only in *Elicura* and in

a few species of *Lemolemus*. The posterior gonapophysis has scraping setae which are associated with oviposition on rocks. Forewing vein CuP originates close to basal crossvein which is a plesiomorphic condition approaching the Old World Myrmecaelurini. Structurally, it appears most closely related to *Neulatus*. Larvae of this genus were found on boulders. They have abdominal scoli and odd medial processes bearing dolichasters on abdominal segments I-IV. Most of the body is covered with scale-like setae.

20. *Galapagoleon* Stange, New Genus (Fig. 23)

Type Species: *Brachynemurus darwini* Stange 1969, by present designation.

Adult Description: Antennal fossae separated by less than width of scape; distal palpomere of labium swollen; profemur without white bristles on exterior face except 3 subapical ones; procoxa with only 2 white bristles posteriorly that are less than one-half coxal diameter; profemoral sense hair about three-fourths length of femur, over twice as long as mesofemoral sense hair; pretarsal claws well developed, longer than basitarsus but shorter than tibial spurs; tibial spurs of same length in both sexes; forewing costal area simple, except 1 or 2 interconnected crossveins distally; forewing radial sector arises well basad of cubital fork, in contrast to position of hindwing radial sector which arises a little basad of medial fork; hindwing with 2 presectoral crossveins; forewing posterior area highest near end of vein 2A; anterior banksian line developed; hindwing shorter than forewing, in repose wing apices nearly coincide; male sternite IX large, somewhat wider than long, bearing long setae; ectoproct simple but postventral lobe indicated, without processes; male genitalia with gonarcus a simple arch, mediuncus somewhat longer than wide with ridges; paramere with hook; female terminalia with large sclerotized pregenital plate which lacks medial tooth; gonapophyseal plate large and expansive; posterior gonapophysis swollen and curved subapically; ectoproct without digging setae, those on lateral gonapophysis only moderately developed; sternite VII not produced medially; tergite IX of female not produced ventrally; anterior gonapophysis swollen; female abdominal tergite VII without posterior row of bristles.

Larval Description: Unknown.

Included Species: *darwini* (Stange).

Distribution: Galapagos Islands.

Discussion: This genus contains one species found in the Galapagos Islands. Its taxonomic position is unclear but is referred to the Lemolemini based on overall similarity. The curved posterior gonapophysis is similar to *Ecualeon*. The discovery of the larval stage will probably clarify its relationships.

21. *Lemolemus* Navás (Fig. 26)

Lemolemus Navás, 1911. Rev. chilena Hist. nat. 15:123.

Type species: *Lemolemus nectator* Navás, by original designation (= *L. modestus* (Blanchard) 1851).

=*Puren* Navás, 1911. Rev. chilena Hist. nat. 15:125.
New synonym. **Type species:** *Puren bellator* Navás, by original designation (= *L. modestus* (Blanchard) 1851).

=*Licura* Navás, 1918. Bol. soc. aragonesa 17:330. New synonym. **Type species:** *Licura ferus* Navás, by original designation (= *L. modestus* (Blanchard) 1851).

Adult Description: Antennal fossae separated by about width of pedicel; distal palpomere of labium slender; profemur without white bristles on exterior face except subapically; profemur sense hair moderately long, about one-half length of femur, about equal to that of mesofemur; pretarsal claws longer than pro-basitarsus, shorter or longer than tibial spurs; tibial spurs usually shorter in males; forewing costal area simple or biareolate; forewing radial sector arises well basad of cubital fork, about equivalent to the distance between radial sector and medial fork in hindwing; hindwing about same length as forewing, in repose hindwing extends beyond forewing; anterior banksian line of forewing weakly developed or absent; male sternite IX much wider than long, weakly produced medially; male ectoproct simple, without lobes or processes; male genitalia with arched gonarcus, mediuncus present or absent, not ridged; female terminalia with sternite VII not produced; tergite IX not produced ventrally; pregenital plate sclerotized, wider than long, with median tooth; anterior gonapophysis lobe-like, posterior gonapophysis swollen, but rela-

tively short; ectoproct and lateral gonapophysis without digging setae.

Larval Description (based on *modestus* and several unnamed species): Head capsule longer than wide, with dolichasters; mandible nearly uniform color except darker basally; anterior mesothoracic scolus 1.5X longer than wide, with pale dolichasters; other scoli wider than long; abdomen without scoli; abdomen with median row of tufted black setae; pretarsal claws without basal tooth; mesothoracic spiracle borne on tubercle that is longer than wide; abdominal spiracles enlarged, borne on tubercles.

Included Species: *modestus* (Blanchard)

Distribution: Central Chile.

Discussion: This genus is in need of revision. One taxonomic problem is that the males and females of the same species are variable in the length of the tibial spurs. The lobe-like anterior gonapophysis found in this genus is remarkable and points to a possible relationship with Dendroleontini. An autapomorphy is the sexual dimorphism in the length of tibial spurs. I have been able only to identify by name one species but several other species are present.

22. *Neulatus* Navás (Figs. 27, 64-65)

=*Lincoya* Navás, 1911. Rev. chilena Hist. nat. 15:121.

Type species: *Lincoya dealbatus* Navás, by original designation. Preoccupied by *Lincoya* Kirby, 1871 (Lepidoptera)

Neulatus Navás, 1912b. Arxivs Inst. Ciencias 1:108.

Type species: *Glyptobasis porteri* Brethes, by original designation.

=*Nilcoya* Navás, 1913. Rev. chilena Hist. nat. 17:243.
New Synonym. New name for *Lincoya* Navás

Adult Description: Antennal fossae separated by more than width of pedicel; distal palpomere of labium slender; profemur without white bristles on exterior face; profemoral hair short, less than one-fourth length of femur, equal to that of mesofemur; pretarsal claws shorter than meta-basitarsus, about equal to length of tibial spurs; tibial spurs of equal lengths in both sexes; forewing costal area simple;

forewing radial sector arises well basad of cubital fork, about equivalent to the distance between radial sector and medial fork in hindwing; anterior banksian line weakly developed; hindwing as long as forewing, in repose apex of hindwing extends beyond that of forewing; male sternite IX transverse; male ectoproct simple, without lobes or processes; male genitalia with simple arched gonarcus, mediuncus not developed, paramere short, plate-like, ventrally produced; female terminalia (Fig. 27) with pregenital plate large, narrow, posterior end hood-like; sternite VII with narrow median lobe; posterior gonapophysis large, apically swollen; ectoproct without digging setae; lateral gonapophysis with numerous short digging setae; tergite IX with median lobe ventrally; anterior gonapophysis plate-like, gonapophyseal plate expansive.

Larval Description (based on *porteri*): Head longer than wide, with dolichasters on dorsal surface similar to those on rest of dorsum; thoracic and abdominal scoli well developed, at least 3X longer than wide, without dolichasters; abdomen with weak row of clumped dolichasters; pretarsal claw with basal tooth; mesothoracic spiracle borne on tubercle that is longer than wide; abdominal spiracles small, dark, but somewhat elevated.

Included species: Only *porteri* (Brethes) (= *dealbatus* (Navas)).

Distribution: Central Chile.

Discussion: The female terminalia (Fig. 27) of this genus are apomorphic and highly modified. Tergite IX has a large ventral lobe not duplicated elsewhere in the tribe. Also, the median process of sternite VII is unique. The very pale larvae live in *Puya* plants and were collected by Miller, Solervicens, and Stange (1989) by beating the dead leaves and bracts. The larvae move fairly fast and have elongate abdominal scoli (Brethes 1908:15, larva). The type species is based on a larva which was misidentified as an ascalaphid. The pale adults rest on *Puya* plants during the day and are attracted to lights.

23. *Sical* Navás (Fig. 67)

Sical Navás, 1928. Rev. chilena Hist. Nat. 31:317. **Type species:** *Sical peralinius* Navás, by original designation.

=*Neteta* Navás, 1934. Rev. chilena Hist. Nat. 38:10. New synonym. **Type species:** *Neteta barrosi* Navás, by original designation.

=*Chiloleon* Navás, 1934. Rev. chilena Hist. Nat. 38:10. New synonym. **Type species:** *Chiloleon stuardinus* Navás, by original designation.

Adult Description: Antennal fossae separated by about width of pedicel; distal palpomere of labium slender; profemur without white bristles on exterior face except subapically; profemur sense hair moderately long, about one-half length of femur, about equal to that of mesofemur; pretarsal claws longer than pro-basitarsus, shorter or longer than tibial spurs; tibial spurs usually shorter in males; forewing costal area simple; forewing radial sector arises well basad of cubital fork, about equivalent to the distance between radial sector and medial fork in hindwing; hindwing about same length as forewing, in repose hindwing extends beyond forewing; anterior banksian line of forewing weakly developed; male sternite IX much wider than long, weakly produced medially; male ectoproct simple, without lobes or processes; male genitalia with arched gonarchus, mediuncus present; female terminalia with sternite VII not produced; tergite IX not produced ventrally; pregenital plate sclerotized, without median tooth; anterior gonapophysis lobe-like; posterior gonapophysis swollen, but relatively short; ectoproct and lateral gonapophysis without digging setae.

Larval Description (based on *peralinius*): Head capsule wider than long with many dolichasters and fine white hair; mandible nearly uniform dark brown; first 3 pairs of thoracic scoli longer than wide; abdominal scoli present but wider than long; all scoli with fine, white hair; abdomen with row of tufted black setae; pretarsal claw without basal tooth; mesothoracic spiracle borne on tubercle that is about as long as wide; abdominal spiracles enlarged, borne on tubercles.

Included species: *barrosi* (Navás), *peralinius* Navás, and *stuardinus* (Navás).

Distribution: Central Chile.

Discussion: This genus is sustained mostly by the larval stage which has moderately developed abdominal scoli in contrast to *Elicura* and *Lemolemus*. The female terminalia are most similar to

Lemolemus but the pregenital plate lacks the median tooth. The larva lives in soil and carries debris held by long white setae and scoli. At least one additional species is found in this genus. Autapomorphies for this genus are the long, white setae on the scoli and the lack of a median tooth on the female pregenital plate.

Acknowledgements

The author is grateful to Robert Bruce Miller for the photographs of the larvae and for many constructive ideas. John Oswald made a vigorous critique of the manuscript. Although the selection of the characters used in the cladistic analysis was done solely by the author, special thanks are due to David Wahl who spent many hours analyzing data. Thanks are also due to the typists of the manuscript, Michelle M. Faniola and Brenda J. Lovelace. The illustrations are original except for Figures 9-19, 22, 30-32, 36, 38-46, and 50-59 which are taken from Stange (1970), 23 from Stange, (1969) and Fig. 8 (Adams, 1957).

References

- Adams, Phillip A.** 1957. New antlions from the southwestern United States. *Psyche* 63:82-108.
- Adams, Phillip A.** 1958. Studies in the Neuroptera, with special reference to wing structure and evolution in the Osmyloidea. Ph. D. Thesis, Harvard University, 105 pp., 79 Figs. (unpublished).
- Banks, Nathan.** 1899. A classification of the North American Myrmeleonidae. *Canadian Entomologist* 31:67-71.
- Banks, Nathan.** 1901a. A new genus of Myrmeleonidae. *Canadian Entomologist* 32:329-330.
- Banks, Nathan.** 1901b. A list of neuropteroid insects from Mexico. *Transactions of the American Entomological Society* 27:361-371.
- Banks, Nathan.** 1909. New genera and species of tropical Myrmeleonidae. *Journal of the New York Entomological Society* 17:1-4.
- Banks, Nathan.** 1913a. Synopses and descriptions of exotic Neuroptera. *Transactions of the American Entomological Society* 39:201-242.
- Banks, Nathan.** 1913b. The genus *Brachynemurus* (Neuroptera). *Entomological News* 24:63-65.
- Banks, Nathan.** 1924. Descriptions of new neuropteroid insects. *Bulletin Museum of Comparative Zoology* 65:421-455.
- Banks, Nathan.** 1927. Revision of the Nearctic Myrmeleonidae. *Bulletin Museum of Comparative Zoology* 68:1-81.
- Banks, Nathan.** 1939. On some new and previously-known Neuroptera in the collection of the Academy of Natural Sciences of Philadelphia. *Notulae Naturae* 32:1-5.
- Banks, Nathan.** 1943. Neuroptera of northern South America. Part 2. Myrmeleonidae. *Boletín de entomología venezolana* 2:161-173.
- Brethes, Juan.** 1908. Descripción de una larva de Glyptobasis? de Chile. *Revista chilena de entomología* 12:15-17, pl. II.
- Carpenter, J. M.** 1988. Choosing among multiple equally parsimonious cladograms. *Cladistics* 4:291-296.
- Currie, Rollo.** 1901. A dwarf ant-lion fly. *Proceedings Entomological Society of Washington* 4:435-437.
- Esben-Petersen, Peter.** 1928. Neue und wenig bekannte Neuropteren des Hamburger museums. *Deutsche entomologische Zeitschrift* (1928):73-77.
- Farris, J. S.** 1969. A successive approximations approach to character weighting. *Systematic Zoology* 18:374-385.
- Farris, J. S.** 1989. Hennig86 reference: documentation for version 1. 5. Port Jefferson Station, New York.
- Fraser, F. C.** 1952. New species of Neuroptera in the Museum National d'Histoire naturelle, Paris. *Revue Française d'Entomologie* 19:55-64.
- Hagen, Hermann.** 1888. Stray notes on Myrmeleonidae. Part 4. *Canadian Entomologist* 20:34-38.

- Henry, Charles S.** 1978. An unusual ascalaphid larva (Neuroptera: Ascalaphidae) from southern Africa, with comments on larval evolution within the Myrmeleontoidea. *Psyche* 85:265-274.
- MacLeod, Ellis G.** 1970. The Neuroptera of the Baltic amber. I. Ascalaphidae, Nymphidae, and Psychopsidae. *Psyche* 77:147-180.
- Miller, Robert B.** 1990. Reproductive characteristics of some western hemisphere ant-lions (Insecta: Neuroptera: Myrmeleontidae). Proceedings of the Third international symposium on Neuropterology (Berg en Dal, Kruger National Park), pp. 171-179.
- Navás, Longinos.** 1911. Neuropteros chilenos (Series 2). *Revista chilena de Historia Natural* 15:121-128.
- Navás, Longinos.** 1912a. Notas sobre Mirmeleonidos. *Broteria (Serie Zoológica)* 10:29-97.
- Navás, Longinos.** 1912b. Sinopsis de los Ascalafidos. *Arxius de l'Institut de Ciencies, Barcelona* 1(3):45-143, 11 Figs. , 2 pls.
- Navás, Longinos.** 1913. Mirmeleonido e Chile. *Revista chilena de Historia natural* 17:243-244.
- Navás, Longinos.** 1914a. Neuropteros sudamericanos (Serie 1). *Broteria (Serie Zoológica)* 12:45-56.
- Navás, Longinos.** 1914b. New Neuroptera from the United States. *Bulletin of the Brooklyn Entomological Society* 9:13-20.
- Navás, Longinos.** 1915a. Neuropteros nuevos o poco conocidos. *Memoria della R. Academia Ciencias y Artes Barcelona* (3) 11:373-398, 455-480.
- Navás, Longinos.** 1915b. Neuropteros Sudamericanos (Serie 2). *Broteria (Serie Zoológica)* 13:5-13.
- Navás, Longinos.** 1918. Insectos chilenos. *Boletín de la Sociedad aragonesa de Ciencias Naturales* 17:212-230.
- Navás, Longinos.** 1919. Algunos insectos neuropteros de República Argentina. *Revista de la real Academia de ciencias exactas, Físicas y naturales de Madrid* 17:288-305.
- Navás, Longinos.** 1920. Sur des Neuropteres nouveaux ou critiques (Serie 2). *Annales Societe Scientifique de Bruxelles* 39:189-203.
- Navás, Longinos.** 1922. Insectos Sudamericanos (Series 4). *Revista de la real Academia de ciencias exactas, Físicas y naturales de Madrid* 19:255-267.
- Navás, Longinos.** 1924. Insectos de la America central. *Broteria (Serie Zoológica)* 21:55-86.
- Navás, Longinos.** 1926a. *Insecta nova (Series XI). Memorie dell'Accademia pontifica dei Nuovi Lincei, Rome* 9:101-110.
- Navás, Longinos.** 1926b. Algunos insectos del Brasil (Series 3). *Broteria (Serie Zoológica)* 23:5-15.
- Navás, Longinos.** 1927. *Insecta nova (Series XII). Memorie dell'Accademia pontifica dei Nuovi Lincei, Rome* 10:1-10.
- Navás, Longinos.** 1928. Insectos neotropicos (Series 3). *Revista chilena de historia natural* 31:316-325.
- Navás, Longinos.** 1932. Alcuni insetti del museo di zoologia della R. Università di Torino. *Bollettino dei Musei di Zoologia e di Anatomia Comparata della R. Università di Torino* (3)42:1-38.
- Navás, Longinos.** 1934a. Algunos insectos de Chile (6a Serie). *Revista chilena de historia natural* 38:9-12.
- Navás, Longinos.** 1934b. Insectos suramericanos (8 Serie). *Revista de la real Academia de Ciencias exactas, Físicas y naturales de Madrid* 31:9-28.
- New, T. R.** 1981. A revision of the Australian Nymphidae (Insecta: Neuroptera). *Australian Journal of Zoology* 29:707-750, Figs. 1-188.

- New, T. R.** 1982. A reappraisal of the status of the Stilbopterygidae (Neuroptera: Myrmeleontoidea). *Journal of the Australian Entomological Society* 21:71-75.
- Nixon, K. C.** 1992. Clados reference: documentation for version 1. 1. Trumansburg, New York.
- Oswald, J. O.** 1993. Phylogeny, taxonomy, and biogeography of extant silky lacewings (Insecta: Neuroptera: Psychopsidae). *Memoirs of the American Entomological Society* 40:1-65.
- Stange, Lionel A.** 1969. Myrmeleontidae of the Galapagos Islands. *Acta zoologica Lilloana* 25:187-198.
- Stange, Lionel A.** 1970. Revision of the ant-lion tribe Brachynemurini of North America. University of California Publications in Entomology 55:1-192.
- Stange, L. A. , & R. B. Miller** 1990. Classification of the Myrmeleontidae based on larvae. *Proceedings of the third International Symposium on Neuropterology*. (Berg en Dal, Kruger National Park), pp. 151-169.
- Tillyard, R. J.** 1915. Studies in Australian Neuroptera. No. 1. The wing-venation of the Myrmeleonidae. *Proceedings of the Linnean Society of New South Wales* 40(4):734-751.
- Tjeder, Bo.** 1977. Distal abdominal segments and sclerotized parts of genitalia in Ascalaphidae (Neuroptera). *Annales Entomologici Fennici* 43:61-65.
- Withycombe, C. L.** 1925. Some aspects of the biology and morphology of the Neuroptera, with special reference to the immature stages and their possible phylogenetic significance. *Transactions of the Entomological Society of London* (1924):303-411.

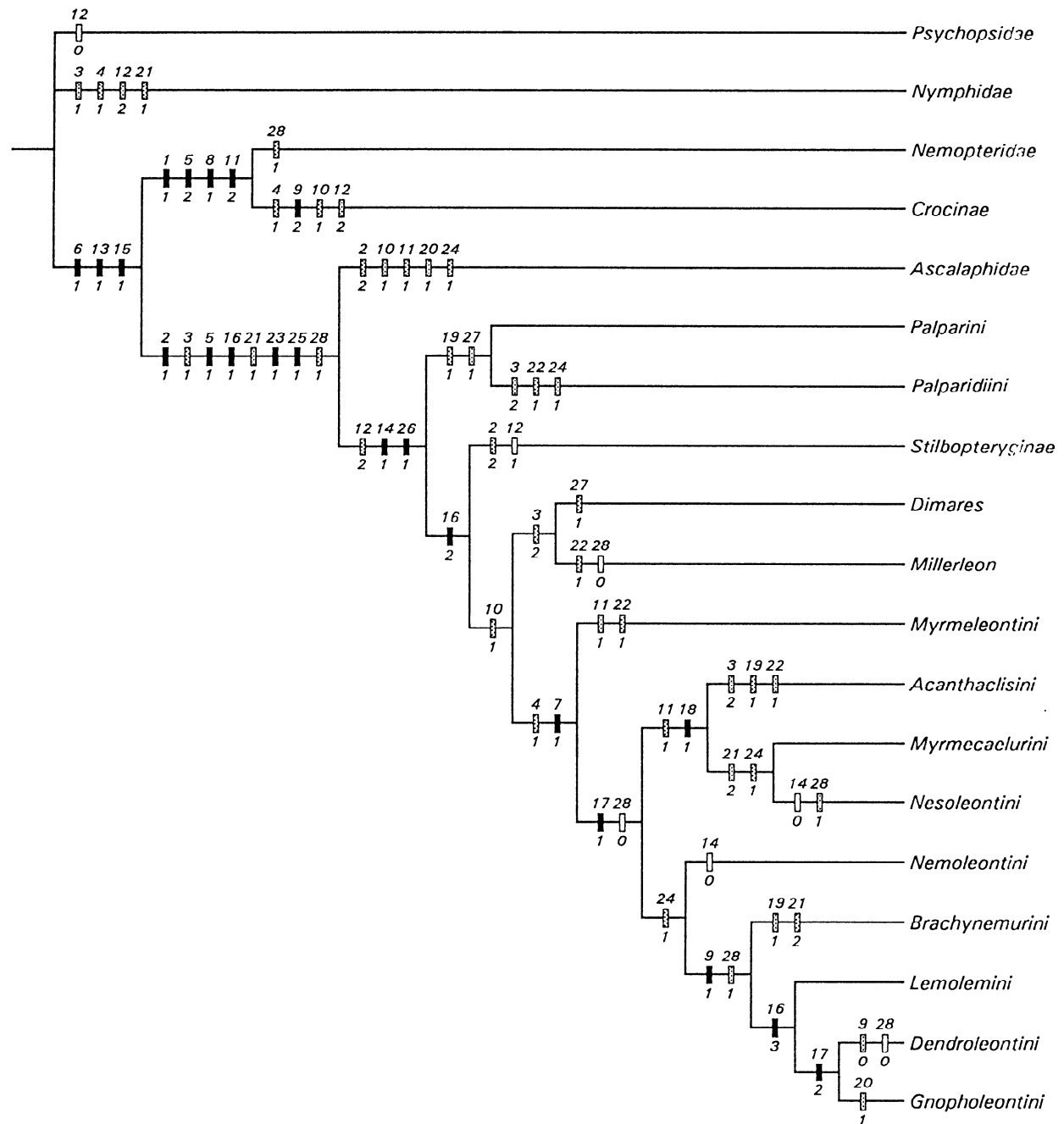

Figure 1. One of 2 cladograms showing group relationships within the Myrmeleontoidea based on adult and larval characters. Black bar = apomorphy; shaded bar = parallelism; white bar = reversal. This cladogram and others were made with the Clados program by Nixon (1992).

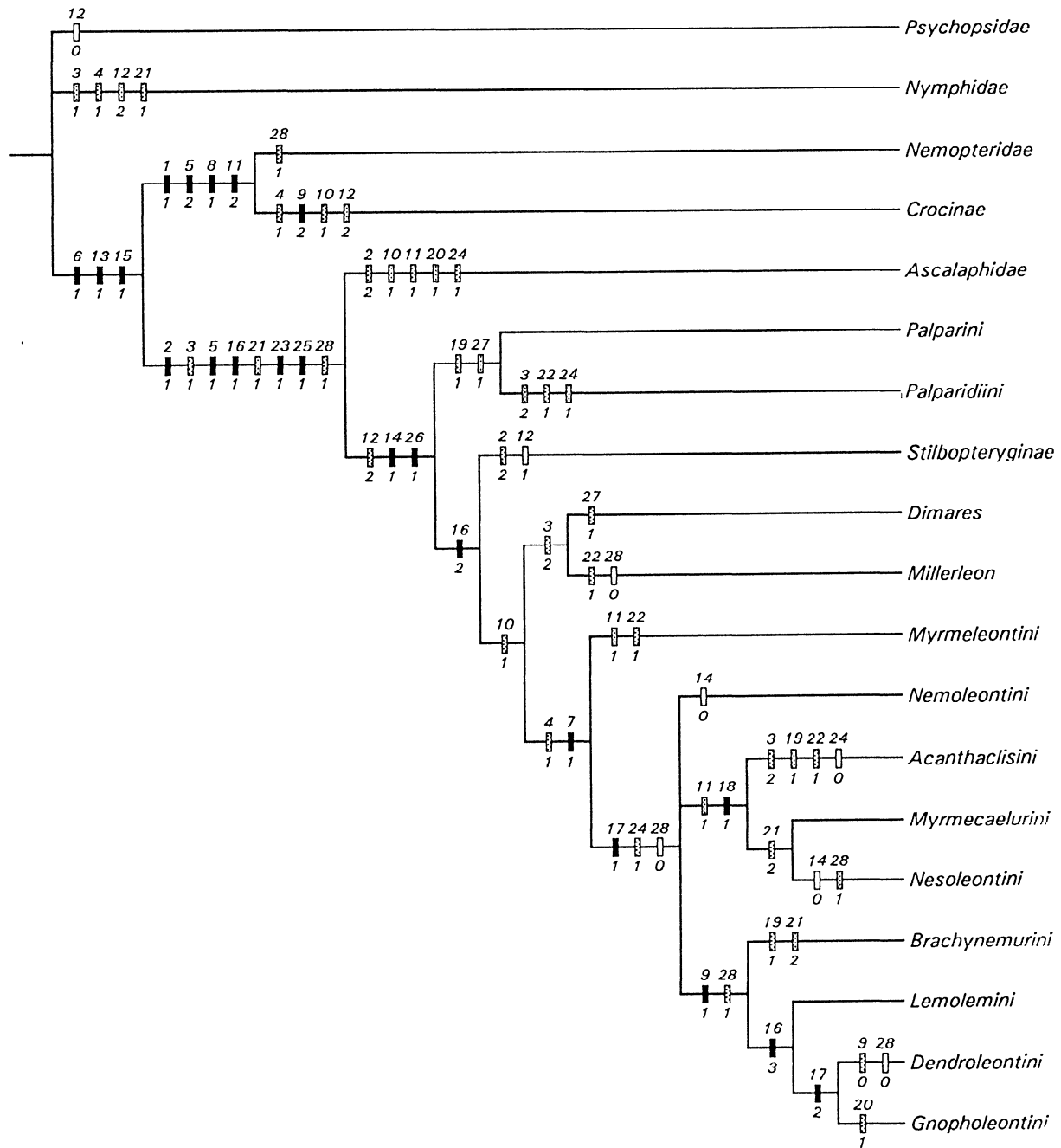

Figure 2. One of 2 cladograms showing group relationships within the Myrmeleontoidea based on adult and larval characters.

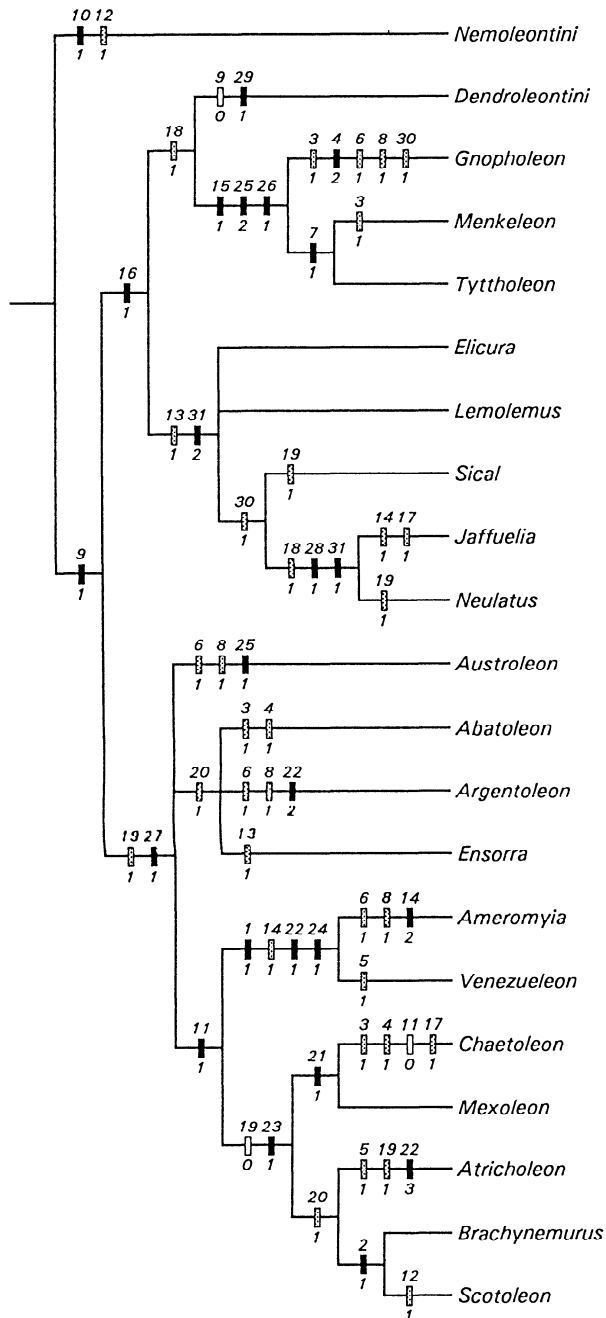

Figure 3. One of 2 weighted cladograms of the genera formerly included in the Brachynemurini, based on adult and larval characters.

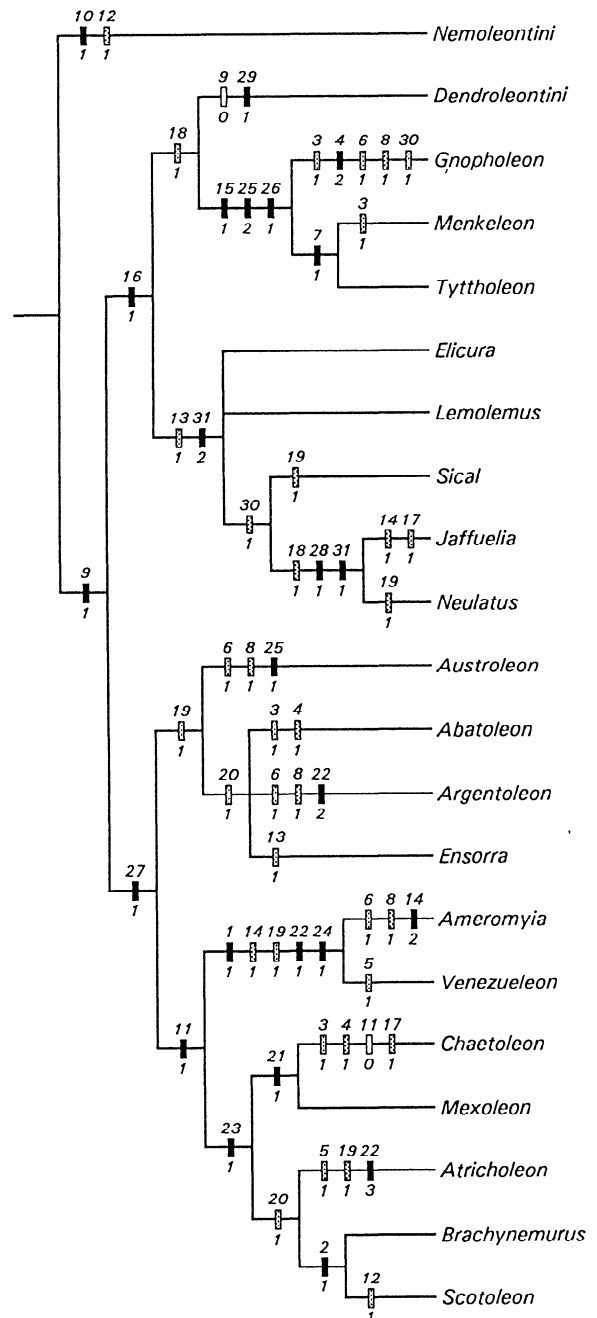

Figure 4. One of 2 weighted cladograms of the genera formerly included in the Brachynemurini, based on adult and larvae characters.

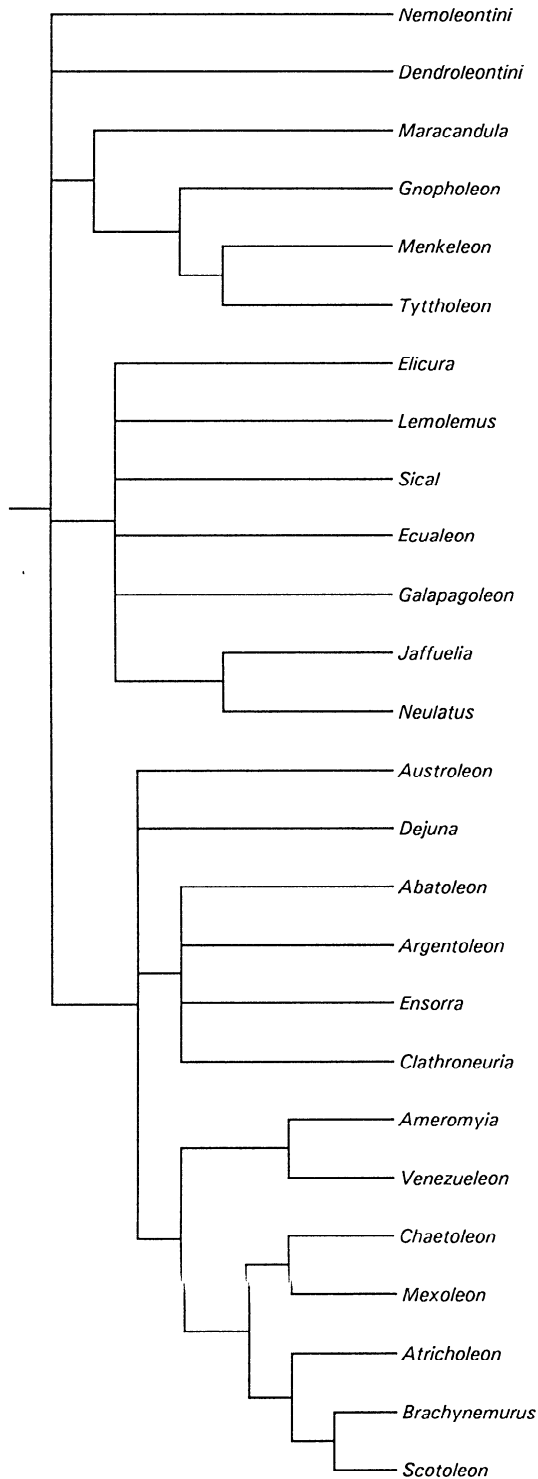

Figure 5. Strict consensus tree of 341 cladograms of the genera of the Brachynemurini & Myrmecaelurini, based on adult and larval characters.

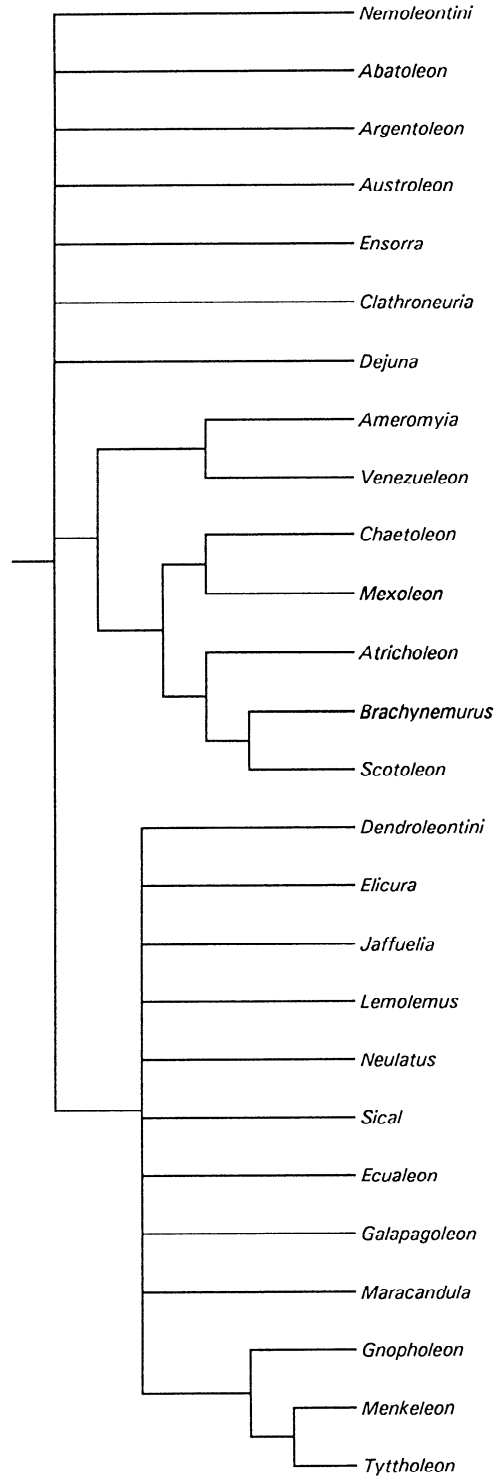
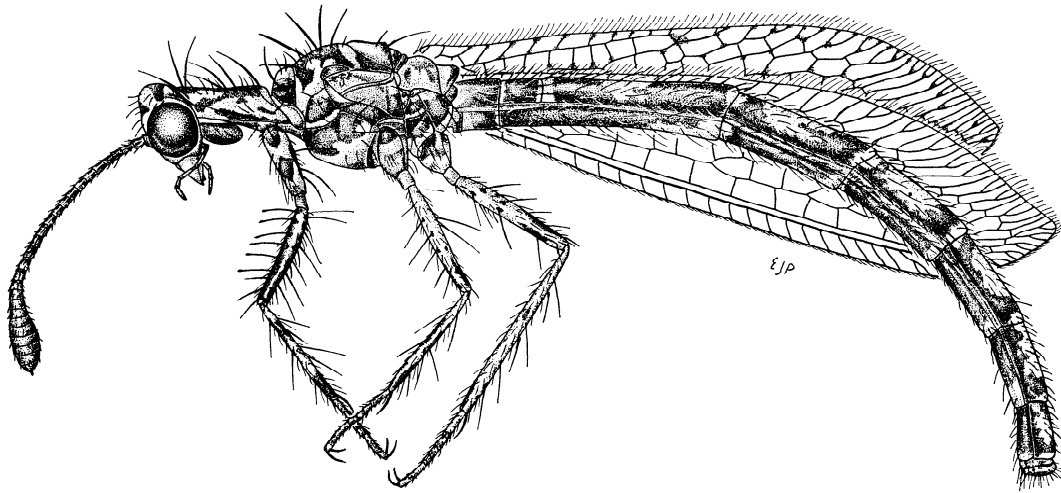
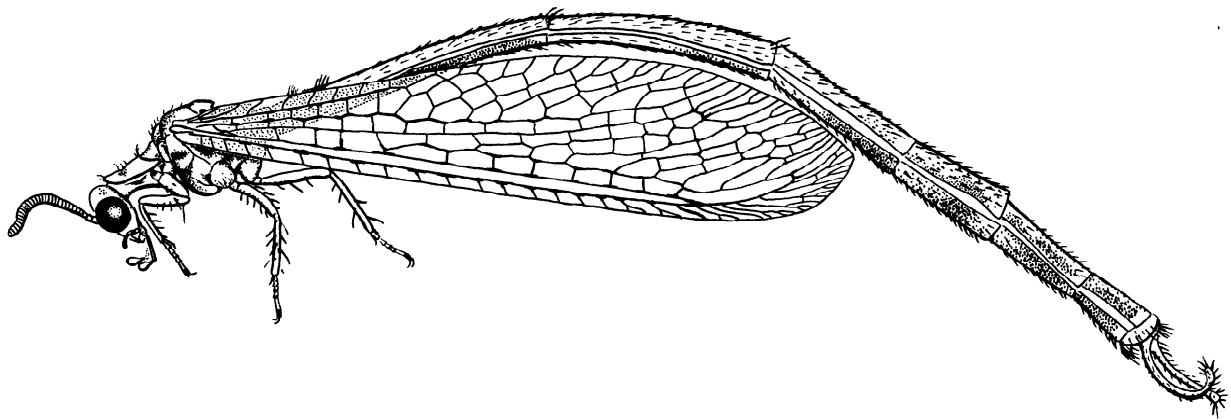

Figure 6. Strict consensus tree of 353 trees showing relationships of the genera formerly included in the Brachynemurini, based on adult characters.



7 - *Chaetoleon pusillus* (Currie)



8 - *Scotoleon deflexus* (Adams)

Figure 7 - 8. 7) Adult habitus drawing of *Chaetoleon pusillus* (Currie) (male). 8) Adult habitus drawing of *Scotoleon deflexus* (Adams) (male).

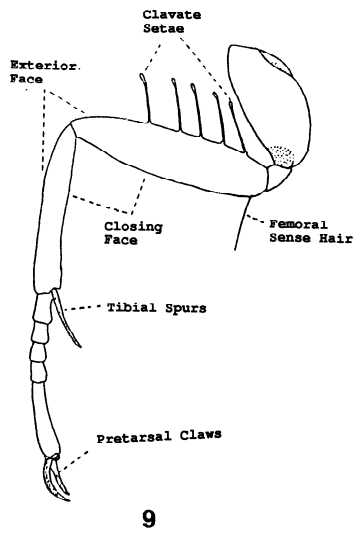

9

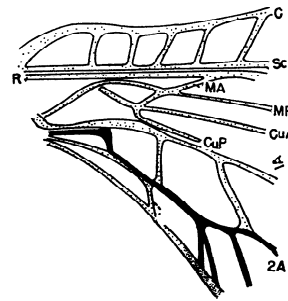

10 - Myrmeleon sp.

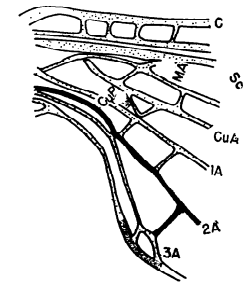

11 - Brachynemurus sp.

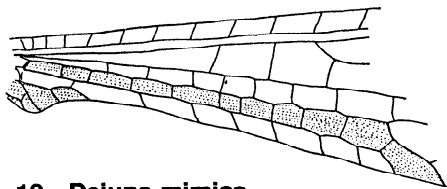

12 - Dejana mimica

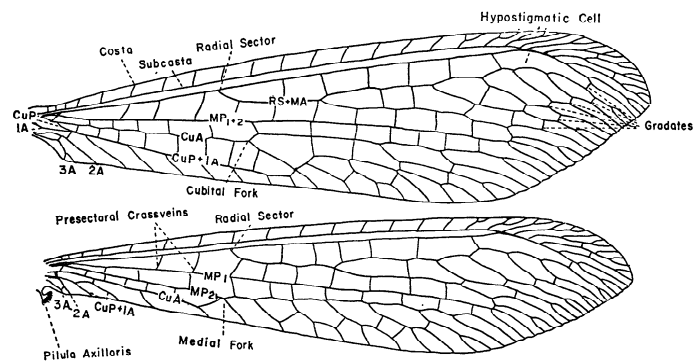

15 - Gnopholeon delicatulus

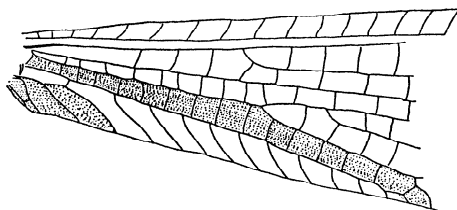

13 - Brachynemurus divisus

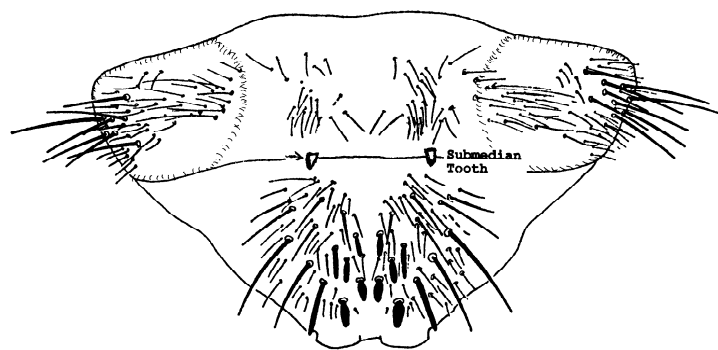

16 - Brachynemurus ferox

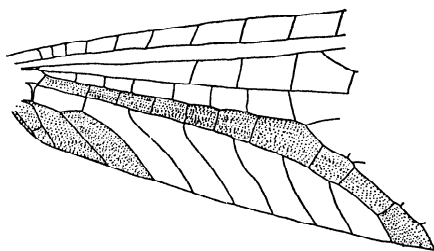

14 - Scotoleon nigrilabris

Figures 9-16. 9) Proleg; 10-11) Base of forewing; 12-14) Base of hindwing; 15) Wings; 16) Ventral apex of larva

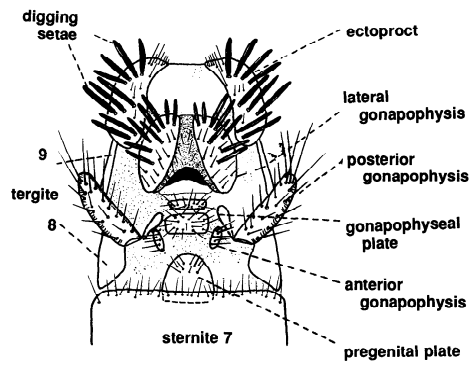

17 - *Brachynemurus* sp.

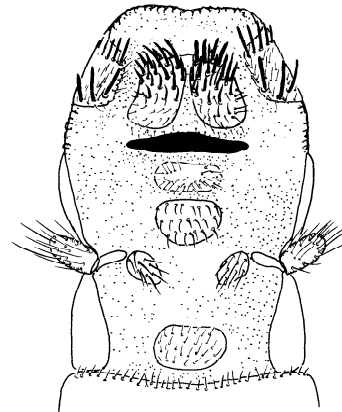

18 - *Scotoleon eiseni*

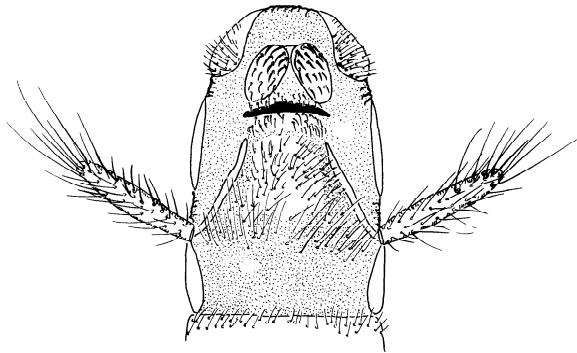

19 - *Abatoleon dorsalis*

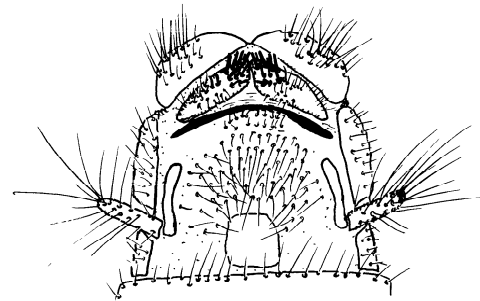

20 - *Ensorra verticalis*

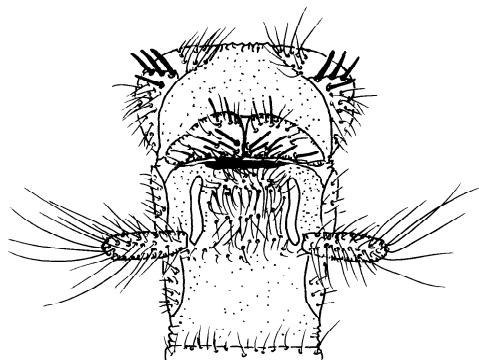

21 - *Venezueleon guaricus*

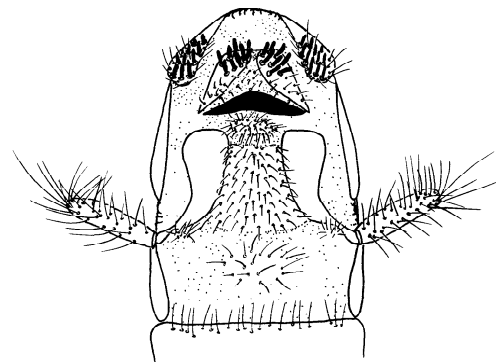

22 - *Dejuna persimilis*

Figures 17-22. Ventral view of female terminalia.

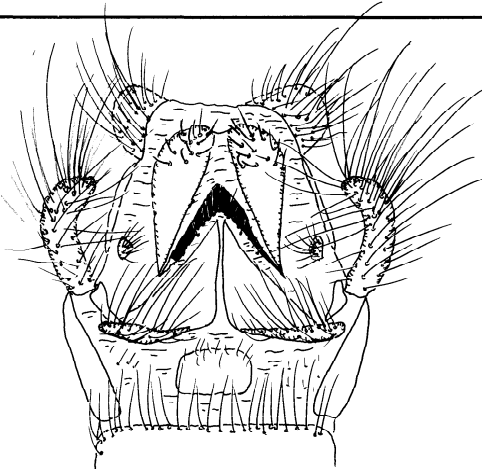

23 - Galapagoleon darwini

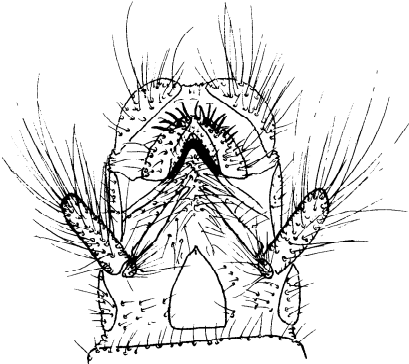

24 - Eilicura litigator

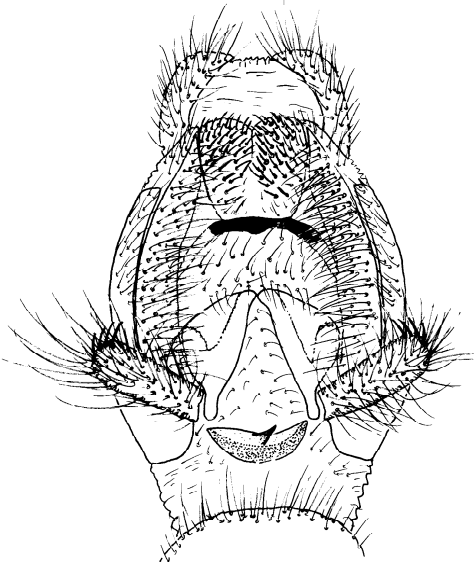

25 - Jaffuelia chilense

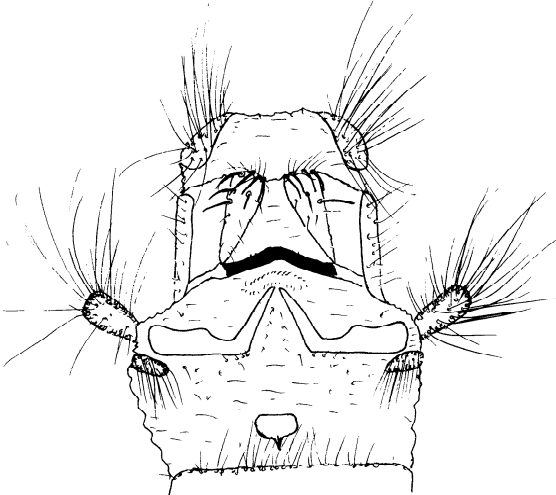

26 - Lemolemus nectator

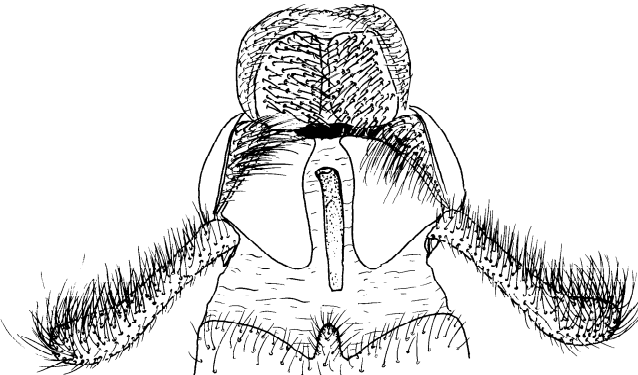

27 - Neulatus porteri

Figures 23-27. Ventral view of female terminalia.

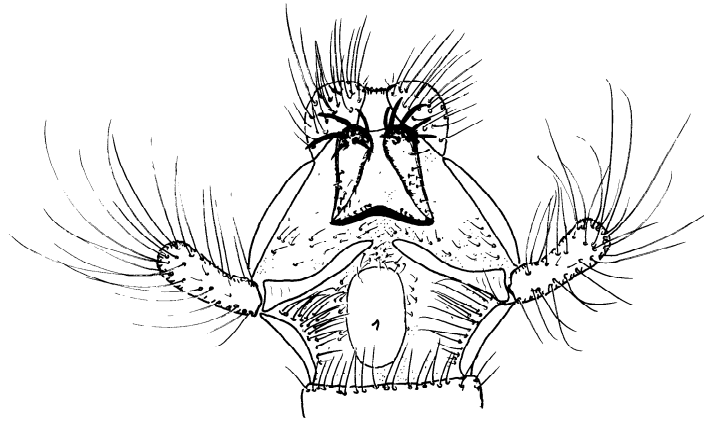

28 - *Nannoleon michaelseni*

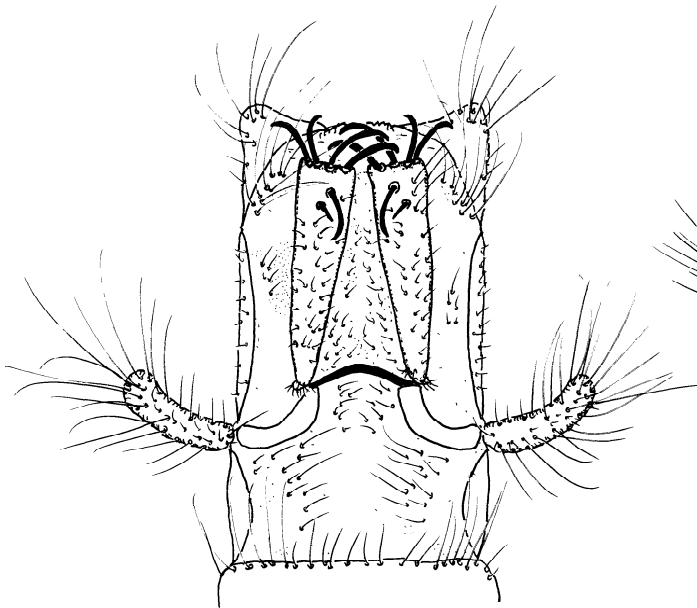

29 - *Myrmecaelurus* sp.

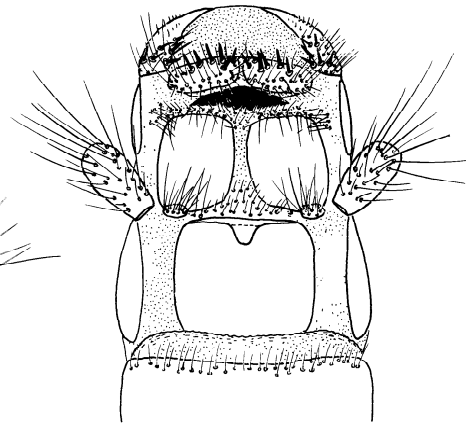

30 - *Tytholeon puerilis*

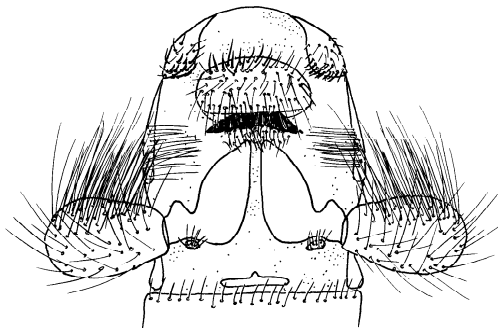

31 - *Maracandula apicalis*

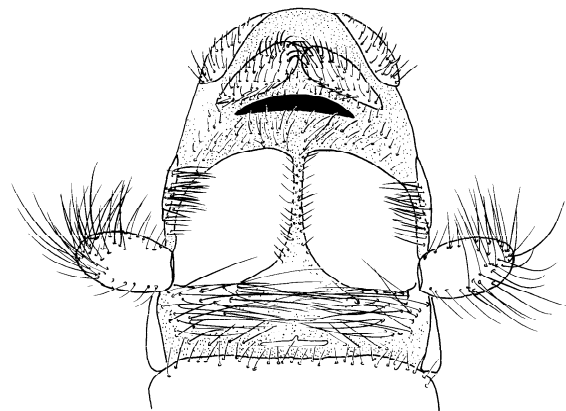

32 - *Gnopholeon delicatulus*

Figures 28-32. Ventral view of female terminalia.

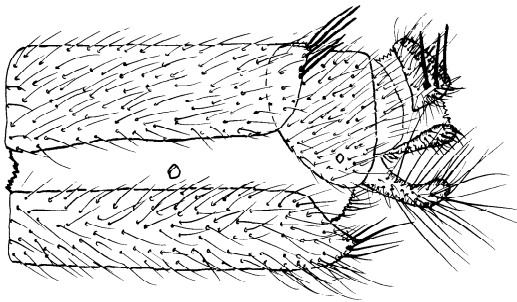

33 - *Ecualeon ovispargus*

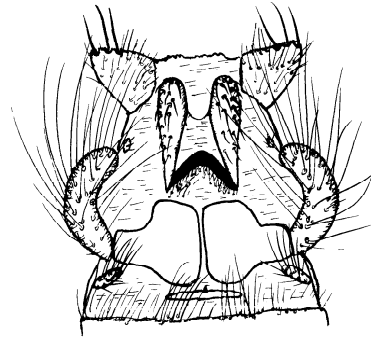

34 - *Ecualeon ovispargus*

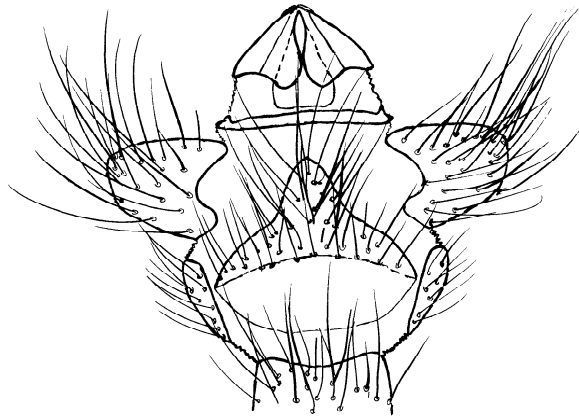

35 - *Ecualeon ovispargus*

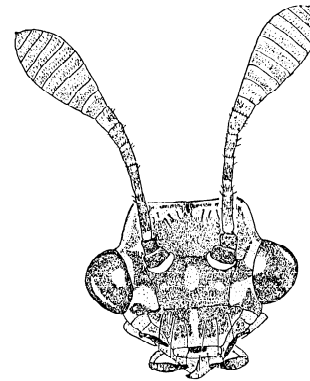

36 - *Maracandula apicalis*



38 - *Mexoleon papago*

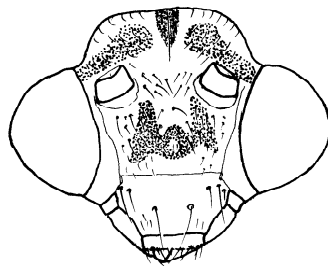

37 - *Ameromyia nigri ventris*

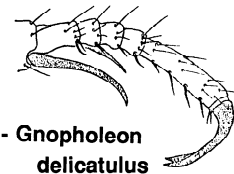

39 - *Gnopholeon delicatulus*

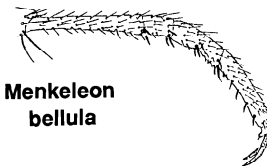

40 - *Menkeleon bellula*

Figures 33-40. 33) Lateral view of female terminalia; 34) Ventral view of female terminalia; 35) Ventral view of male terminalia and genitalia; 36-37) Frontal view of head; 38-40) Hind tarsus.

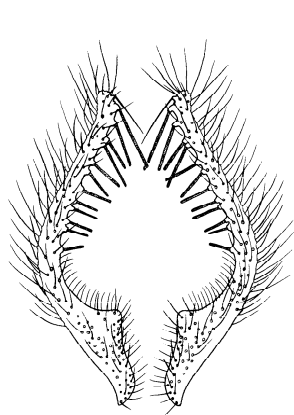

41 - *Atricholeon tuberculatus*

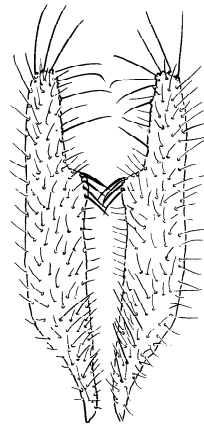

42 - *Brachynemurus seminolae*

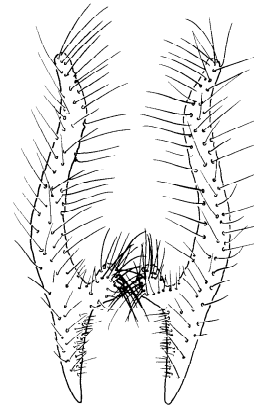

43 - *Clathroneuria schwarzi*

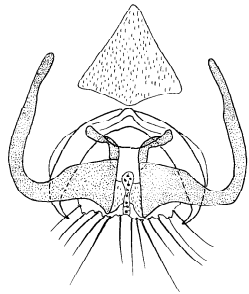

44 - *Atricholeon tuberculatus*

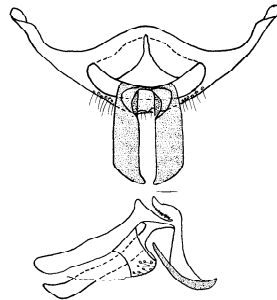

45 - *Dejuna persimilis*

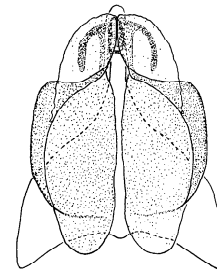

46 - *Clathroneuria schwarzi*

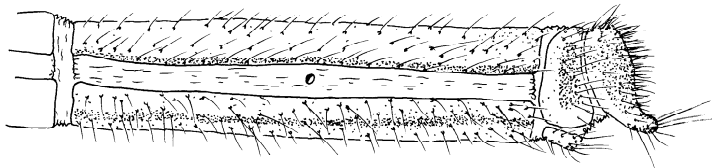

47 - *Venezueleon guaricus*

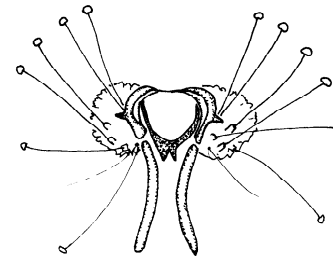

48 - *Venezueleon guaricus*

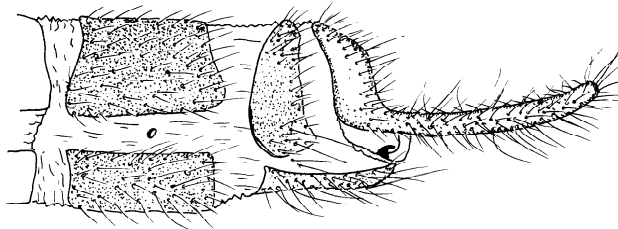

49 - *Ensorra verticalis*

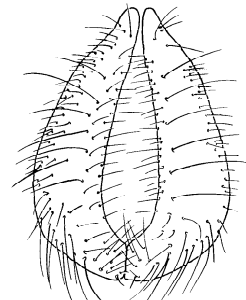

50 - *Tytholeon puerilis*

Figures 41-50. 41-43) Ventral view of male ectoproct; 44-46) Ventral view of male genitalia; 47) Lateral view of male terminalia; 48) Male genitalia; 49) Lateral view of male terminalia; 50) Posterior view of male ectoprocts.

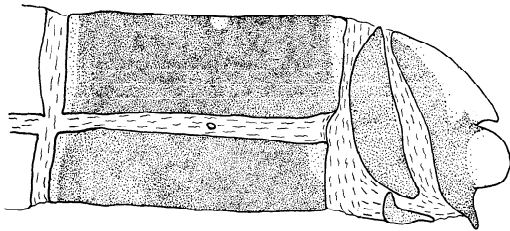

51 - *Mexoleon papago*

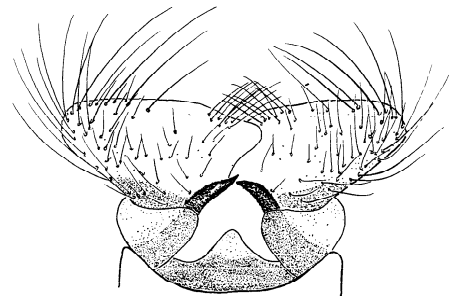

52 - *Mexoleon papago*

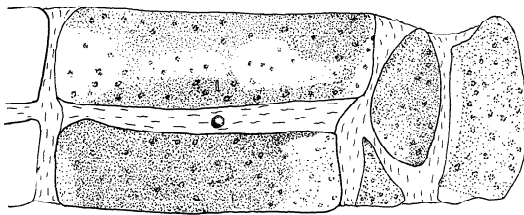

53 - *Chaetoleon pusillus*

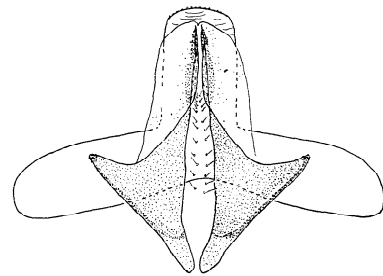

54 - *Chaetoleon pusillus*

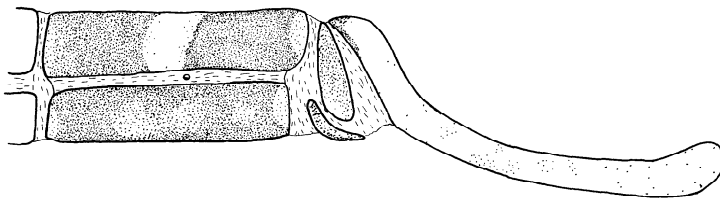

55 - *Brachynemurus pulchellus*

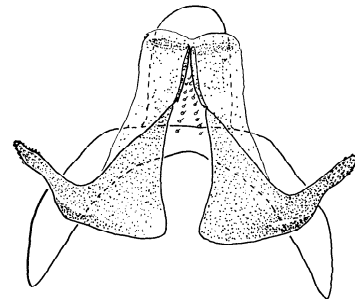

56 - *Brachynemurus pulchellus*

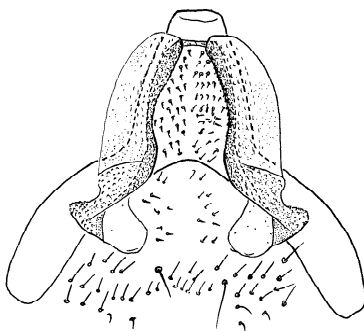

57 - *Tyttholeon puerilis*

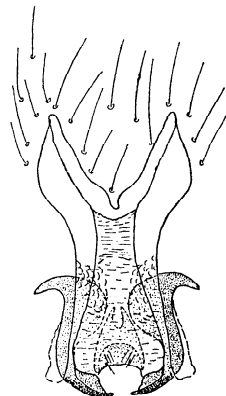

58 - *Abatoleon dorsalis*

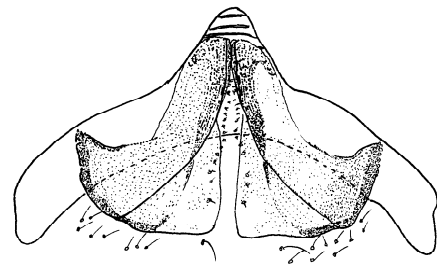

59 - *Maracandula apicalis*

Figures 51-59. 51, 53, 55) Lateral view of male terminalia. 52, 54, 56-59) Posterior view of male genitalia.

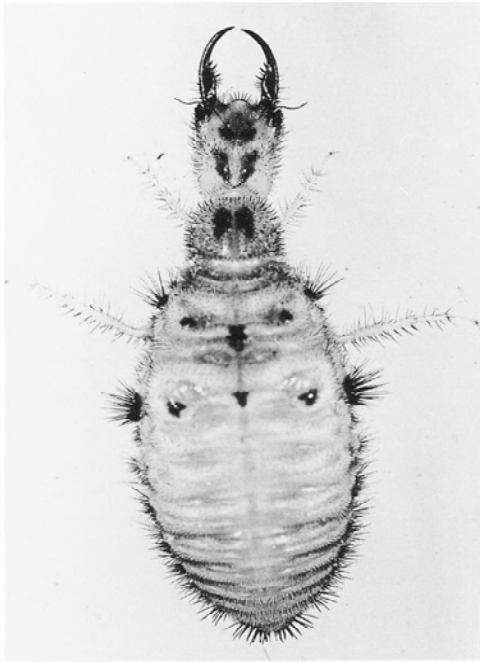

60 - *Scotoleon fidelitas*



61 - *Scotoleon fidelitas*



62 - *Scotoleon pallidus*



63 - *Scotoleon eiseni*

Figures 60-63. Third instar larvae of Brachynemurini.

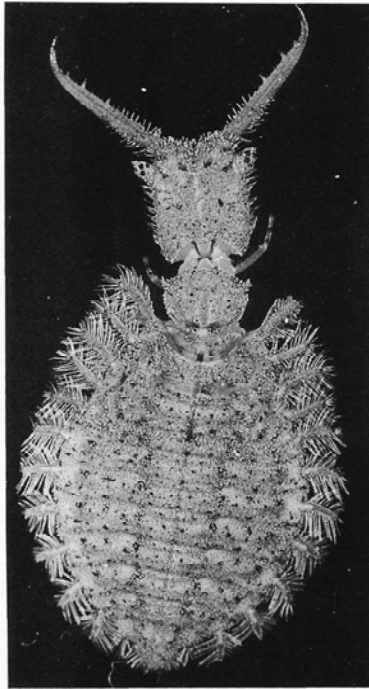

64 - *Neulatus porteri*

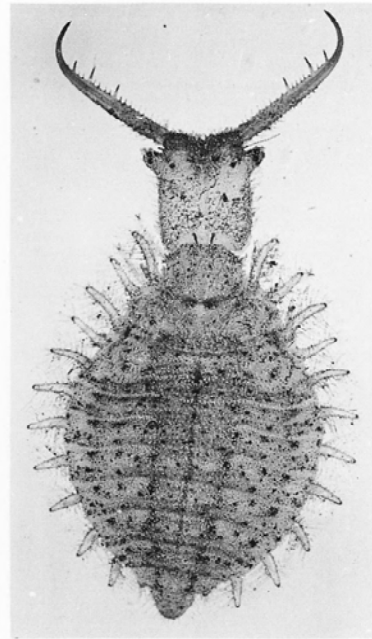

65 - *Neulatus porteri*

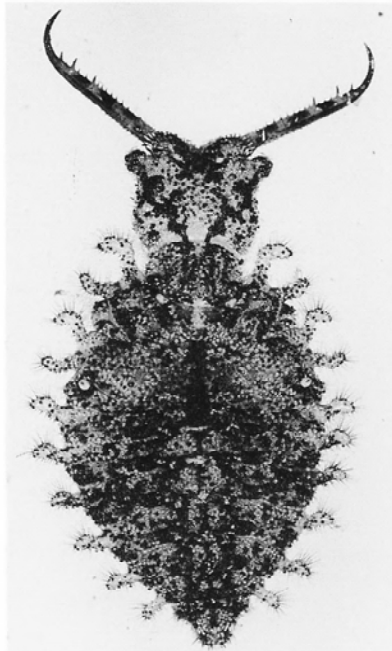

66 - *Jaffuelia chilense*

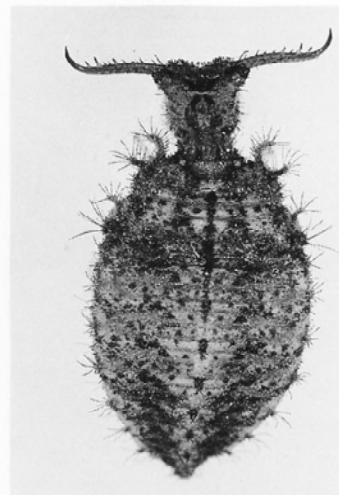

67 - *Sical peralinius*

Figures 64-67. Third instar larvae of Lemolemini.

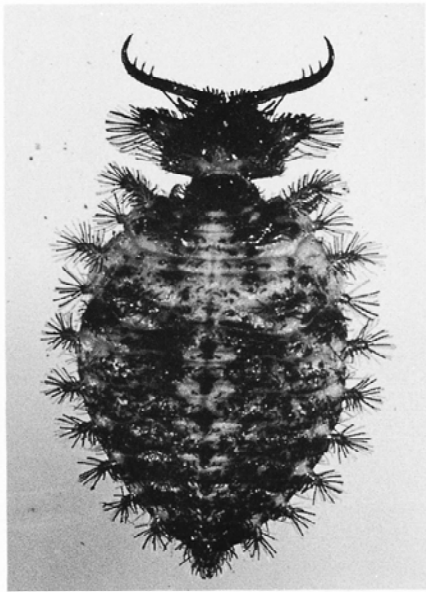

68 - *Gnopholeon barberi*

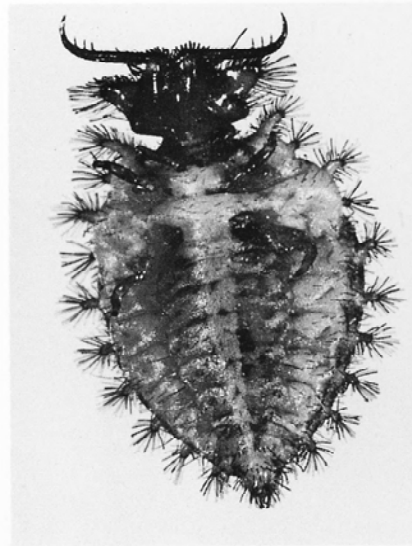

69 - *Gnopholeon barberi*

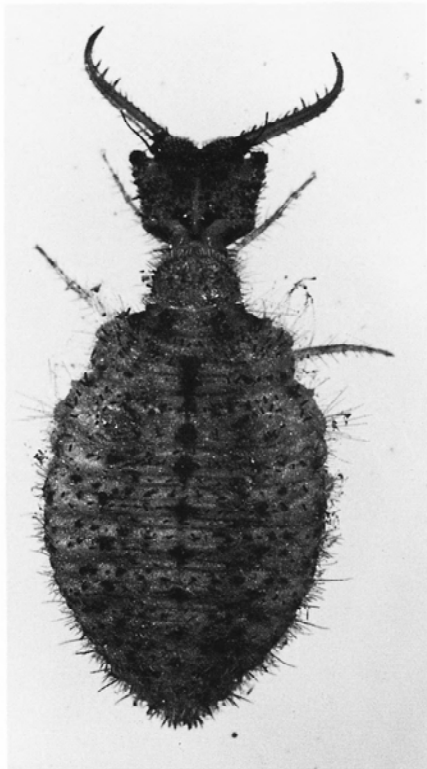

70 - *Menkeleon bellula*



71 - *Tytholeon puerilis*

Figures 68-71. Third instar larvae of Gnopholeontini.

APPENDIX 1. Data Matrix for Tribal Relationships

	Character Number									1 1 1 1 1 1 1 1 1									2 2 2 2 2 2 2 2 2										
	1	2	3	4	5	6	7	8	9	0	1	2	3	4	5	6	7	8	9	0	1	2	3	4	5	6	7	8	
Psychopsidae	0	0	0	0	0	0	0	0	0	0	0	0	0	0	0	0	0	0	0	0	0	0	0	0	0	0	0		
Nymphidae	0	0	1	1	0	0	0	0	0	0	0	2	0	0	0	0	0	0	0	0	0	1	0	0	0	0	0	0	
Nemopterinae	1	0	0	0	2	1	0	1	0	0	2	1	1	0	1	0	0	0	0	0	0	0	0	0	0	0	0	1	
Crocinae	1	0	0	1	2	1	0	1	2	1	2	2	1	0	1	0	0	0	0	0	0	0	0	0	0	0	0	0	
Ascalaphidae	0	2	1	0	1	1	0	0	0	1	1	1	1	0	1	1	0	0	?	1	1	0	1	1	1	0	0	1	
Stilbopterygini	0	2	1	0	1	1	0	0	0	0	0	1	1	1	1	2	0	0	0	0	1	0	1	0	1	1	0	1	
Palparini	0	1	1	0	1	1	0	0	0	0	0	2	1	1	1	1	0	0	1	0	1	0	1	0	1	1	1	1	
Palparidiini	0	1	2	0	1	1	0	0	0	0	0	2	1	1	1	1	0	0	1	0	1	1	1	1	1	1	1	1	
Dimares	0	1	2	0	1	1	0	0	0	1	0	2	1	1	1	2	0	0	0	0	1	0	1	0	1	1	1	1	
Millerleon	0	1	2	0	1	1	0	0	0	1	0	2	1	1	1	2	0	0	0	0	1	1	1	0	1	1	0	0	
Dendroleontini	0	1	1	1	1	1	0	0	0	1	0	2	1	1	1	3	2	0	0	0	1	0	1	1	1	1	0	0	
Nemoleontini	0	1	1	1	1	1	0	0	0	1	0	2	1	0	1	2	1	0	0	0	1	0	1	1	1	1	0	0	
Brachynemurini	0	1	1	1	1	1	0	1	0	1	0	2	1	1	1	2	1	0	1	0	2	0	1	1	1	1	0	1	
Gnopholeontini	0	1	1	1	1	1	0	1	0	1	0	2	1	1	1	3	2	0	0	1	1	0	1	1	1	1	0	1	
Lemolemini	0	1	1	1	1	1	0	1	0	1	0	2	1	1	1	3	1	0	0	0	1	0	1	1	1	1	0	1	
Myrmecaelurini	0	1	1	1	1	1	0	0	0	1	1	2	1	1	1	2	1	1	0	0	2	0	1	1	1	1	0	0	
Nesoleontini	0	1	1	1	1	1	0	0	0	1	1	2	1	0	1	2	1	1	0	0	2	0	1	1	1	1	0	1	
Myrmeleontini	0	1	1	1	1	1	0	0	0	1	1	2	1	1	1	2	0	0	0	0	1	1	1	0	1	1	0	1	
Acanthaclisini	0	1	2	1	1	1	1	0	0	1	1	2	1	1	1	2	1	1	1	0	0	1	1	1	0	1	1	0	0
Maulini	0	1	2	1	1	1	1	0	1	1	1	2	1	1	1	3	0	0	0	?	?	?	?	?	?	?	?	?	
Pseudimarini	0	1	1	1	1	1	0	0	0	0	0	2	0	1	1	1	0	0	0	?	?	?	?	?	?	?	?	?	

APPENDIX 2: Data Matrix for Brachynemurini, Lemolemini and Gnopholeontini

	Character Number									1 1 1 1 1 1 1 1 2									2 2 2 2 2 2 2 2 2 3									3 3				
	1	2	3	4	5	6	7	8	9	0	1	2	3	4	5	6	7	8	9	0	1	2	3	4	5	6	7	8	9	0	1	
Nemoleontini	0	0	0	0	0	0	0	0	0	1	0	1	0	0	0	0	0	0	0	0	0	0	0	0	0	0	0	0	0	0		
Dendroleontini	0	0	0	0	0	0	0	0	0	0	0	0	0	0	0	1	0	1	0	0	0	0	0	0	0	0	0	1	0	0		
Brachynemurini																																
Abatoleon	0	0	1	1	0	0	0	0	1	0	0	0	0	0	0	0	0	0	1	1	0	0	0	0	1	0	0	0	0	0		
Ameromyia	1	0	0	0	0	1	0	1	1	0	1	0	0	2	0	0	0	0	0	1	0	0	1	0	0	1	0	0	0	0	0	
Argentoleon	0	0	0	0	0	1	0	1	1	0	0	0	0	0	0	0	0	0	1	1	0	2	0	0	0	0	1	0	0	0	0	
Atricholeon	0	0	0	0	1	0	0	0	1	0	1	0	0	0	0	0	0	0	1	1	0	3	1	0	0	0	1	0	0	0	0	
Austroleon	0	0	0	0	1	0	1	1	0	0	0	0	0	0	0	0	0	0	1	0	0	0	0	0	1	0	1	0	0	0	0	
Brachynemurus	0	1	0	0	0	0	0	0	1	0	1	0	0	0	0	0	0	0	0	1	0	0	1	0	0	0	1	0	0	0	0	
Chaetoleon	0	0	1	1	0	0	0	0	1	0	0	0	0	0	0	0	1	0	0	0	1	0	1	0	0	0	1	0	0	0	0	
Ensorra	0	0	0	0	0	0	0	0	1	0	0	0	1	0	0	0	0	0	1	1	0	0	0	0	0	0	1	0	0	0	0	
Mexoleon	0	0	0	0	0	0	0	0	1	0	1	0	0	0	0	0	0	0	0	0	1	0	1	0	0	0	1	0	0	0	0	
Scotoleon	0	1	0	0	0	0	0	0	1	0	1	1	0	0	0	0	0	0	0	1	0	0	1	0	0	0	1	0	0	0	0	
Venezueleon	1	0	0	0	1	0	0	0	1	0	1	0	0	1	0	0	0	0	1	0	0	1	0	1	0	0	1	0	0	0	0	
Gnopholeontini																																
Gnopholeon	0	0	1	2	0	1	0	1	1	0	0	0	0	0	1	1	0	1	0	0	0	0	0	2	1	0	0	0	0	1	0	
Menkeleon	0	0	1	0	0	0	1	0	1	0	0	0	0	0	1	1	0	1	0	0	0	0	0	2	1	0	0	0	0	0	0	
Tyltholeon	0	0	0	0	0	0	1	0	1	0	0	0	0	0	1	1	0	1	0	0	0	0	0	2	1	0	0	0	0	0	0	
Lemolemini																																
Elicura	0	0	0	0	0	0	0	0	1	0	0	0	1	0	0	1	0	0	0	0	0	0	0	0	0	0	0	0	0	0	2	
Jaffuelia	0	0	0	0	0	0	0	0	1	0	0	0	1	1	0	1	1	0	0	0	0	0	0	0	0	0	1	0	1	1	1	
Lemolemus	0	0	0	0	0	0	0	0	1	0	0	0	1	0	0	1	0	0	0	0	0	0	0	0	0	0	0	0	0	0	2	
Neulatus	0	0	0	0	0	0	0	0	1	0	0	0	1	0	0	1	0	1	1	0	0	0	0	0	0	0	1	0	1	1	1	
Sical	0	0	0	0	0	0	0	0	1	0	0	0	1	0	0	1	0	0	1	0	0	0	0	0	0	0	0	0	0	0	1	2
Unknown Larvae:																																
Clathroneuria	0	0	0	0	0	1	0	0	1	0	0	0	0	0	0	0	0	1	0	1	0	0	0	0	0	?	?	?	?	?	?	
Dejuna	0	0	0	0	0	0	0	0	1	0	0	0	0	0	0	0	0	1	1	0	0	0	0	0	0	?	?	?	?	?	?	
Ecualeon	0	0	0	0	0	0	0	0	1	0	0	0	1	0	0	1	0	0	0	0	0	0	0	0	?	?	?	?	?	?	?	
Galapagoleon	0	0	0	0	0	0	0	0	1	0	0	0	1	0	0	1	0	0	1	0	0	0	0	0	?	?	?	?	?	?	?	
Maracandula	0	0	0	0	0	0	1	0	1	0	0	0	2	1	1	0	0	0	0	0	0	0	0	0	?	?	?	?	?	?	?	

APPENDIX 3. Successive Approximation Weights for Tribal Analysis

WEIGHT CHARACTER

 0 12, 20, 22, 28
 1 3, 19, 24
 2 4, 10, 14, 21, 27
 3 9, 11
 5 2
 10 1, 5-8, 13, 15-18, 23, 25, 26

APPENDIX 4. Successive Approximation Weights for New World Brachynemurini. Generic Analysis with 5 genera with missing larval data deleted.

WEIGHT CHARACTER

 0 3, 4, 5, 6, 8, 9, 12, 17
 1 .19
 3 14, 30
 4 11, 13, 18, 20
 5 25
 10 1, 2, 7, 10, 15, 16, 21-24, 26-29, 31

APPENDIX 5. Successive Approximation Weights for New World Brachynemurini. Generic Analysis with genera added with missing larval data.

WEIGHT CHARACTER

 0 3, 4, 5, 6, 8, 12, 17
 1 14, 19
 2 18
 3 30
 4 11, 13, 20
 5 25
 10 1, 2, 7, 9, 10, 15, 16, 21-24, 26-29, 31

APPENDIX 6. Successive Approximation Weights for New World Brachynemurini. Generic Analysis of all genera but only adult characters.

WEIGHT CHARACTER

 0 3-6, 8, 9, 12, 17
 1 14, 19
 4 11, 13, 20
 5 25
 10 1, 2, 7, 15, 16, 18, 21-24