



This work is licensed under a Creative Commons Attribution License (CC BY 4.0).

Research article

[urn:lsid:zoobank.org:pub:B08C59C9-6F91-4F3B-B595-5C6E7E6710D0](https://zoobank.org/pub/B08C59C9-6F91-4F3B-B595-5C6E7E6710D0)

A revision of the genus *Rudolfina* Roháček (Sphaeroceridae: Limosiniinae)

Steven Mark PAIERO^{1,*} & Stephen A. MARSHALL²

^{1,2}University of Guelph Insect Collection and Insect Systematics Laboratory, School of Environmental Sciences, University of Guelph, Guelph, Ontario, N1G 2W1, Canada.

*Corresponding author: paieros@uoguelph.ca

²Email: samarsha@uoguelph.ca

¹[urn:lsid:zoobank.org:author:B172670C-2159-4D6B-9542-53406F315DC7](https://zoobank.org/author/B172670C-2159-4D6B-9542-53406F315DC7)

²[urn:lsid:zoobank.org:author:0BBC95DD-0E89-49DC-80BE-E40261E9F5FE](https://zoobank.org/author/0BBC95DD-0E89-49DC-80BE-E40261E9F5FE)

Abstract. The genus *Rudolfina* Roháček, 1987 is revised and redefined with the description of the following nine new species, all from the New World: *R. bucki* sp. nov. (Mexico), *R. exuberata* sp. nov. (widespread, from USA to Brazil), *R. howdeni* sp. nov. (Mexico), *R. megepandria* sp. nov. (Mexico), *R. newtoni* sp. nov. (Mexico), *R. pauca* sp. nov. (Guatemala, Mexico), *R. pilosa* sp. nov. (Mexico), *R. remiforma* sp. nov. (Mexico) and *R. tumida* sp. nov. (Mexico, USA). *Rudolfina* is compared to closely related genera in the *Archiceroptera* genus complex, which in turn is recognized as part of a large, mostly Neotropical clade including *Robustagramma* Marshall & Cui, 2005, *Pterogramma* Spuler, 1924, *Aptilotella* Duda, 1924, *Bitheca* Marshall, 1987, *Bromeloecia* Spuler, 1924 and *Archiceroptera* Papp, 1977.

Keywords. Sphaeroceridae, *Rudolfina*, Limosiniinae, Nearctic, Neotropical.

Paiero S.M. & Marshall S.A. 2020. A revision of the genus *Rudolfina* Roháček (Sphaeroceridae: Limosiniinae). *European Journal of Taxonomy* 593: 1–48. <https://doi.org/10.5852/ejt.2020.593>

Introduction

The genus *Rudolfina* Roháček, 1987 was introduced as a new name for the pre-occupied *Rudolfia* Roháček, 1982, which was originally described for a single Palaearctic species, *Limosina rozkosnyi* Roháček, 1975. Three species have since been described: *R. digitata* Marshall, 1991 and *R. cavernicola* Marshall & Fitzgerald, 1997 from North America (Marshall 1991; Marshall & Fitzgerald 1997) and *R. zhangii* Su, 2017 from China (Su *et al.* 2017). Marshall (1982) also recognized several undescribed species of *Rudolfina* s. str. from Mexico, but deferred publishing descriptions of those species until adequate material was available to properly treat the Neotropical fauna and to determine the limits between *Rudolfina* and superficially similar Neotropical species in the *Archiceroptera* genus complex.

We here redefine the genus *Rudolfina* and describe nine new species following the examination of approximately 2000 specimens of *Rudolfina* and over 6000 specimens of other genera in the *Archiceroptera* genus complex.

Rudolfina is diagnosed by the following characters: (1) mid tibia with 1 proximal anterodorsal seta, 1 medial anterodorsal seta, 1 distal anterodorsal seta and 1 distal posterodorsal seta; (2) costa with 1 well-developed costagial seta; (3) male sternite 5 posteromedially emarginate with darkened lobe or process on each side of the emargination; (4) female tergite 8 tripartite, middle part articulating or fused with the epiproct; (5) epiproct medially weakened; (6) female cercus strap-like, with strong, flattened apical seta; and (7) female abdomen with paired bisetose sclerites posterior to sternite 8. All *Rudolfina* except *R. cavernicola* have the female cercus partially fused with the epiproct. Most of these diagnostic characters are also defining characters that support the genus *Rudolfina*, as defined here, as a monophyletic group. The strongest synapomorphies for the genus are the characters of the female terminalia listed above (characters 4–7), along with the costagial seta (character 2) and the male sternite 5 (character 3).

Material and methods

Collection and storage

Most specimens were collected into soapy water, transferred to alcohol for storage, and later dried and point-mounted. Abdomens of some specimens were removed and cleared in hot 10% potassium hydroxide for 6–10 minutes before being neutralized with 10% acetic acid for 10 minutes, rinsed in deionized water, and then placed in glycerin for examination. Dissected genitalia were stored in glycerin-filled microvials pinned below the specimens.

Specimen data

All label data are presented in a consistent manner, not verbatim from the labels; in a few cases, obvious spelling errors were corrected. Short-forms or abbreviations used on specimen labels are normally interpreted and given in full. Elevations and geographical coordinates are given only if present on the original label. All specimens were given unique identifiers (debu followed by an 8-digit number) and their collection data were captured within the University of Guelph Insect Collection database; these are not repeated in the text except for holotypes or for image reference. The specimen data will ultimately be hosted on Canadensys (<https://www.canadensys.net/>). Collection data for paratypes and other specimens examined were organized alphabetically by country, state/province, and locality name. Distribution maps are given for all New World species (Fig. 21) and were generated using SimpleMappr (Shorthouse 2010). The abbreviation FIT is used to indicate ‘flight intercept trap’.

Terminology

The terminology for external morphology largely follows Cumming & Wood (2010) with a few modifications given below; terminology for male and female genitalia follows Smith & Marshall (2004) with modifications from Cumming & Wood (2010). Figures 1–4 illustrate head chaetotaxy, wing venation, and male and female genitalia. Seta(e) and setula(e) are large and small (respectively) socketed macrotrichia. The CuA_1 and M_1 stub veins are the short portions of these veins that project distally beyond cell dm. The subanal plate connects the posteroventral angles of the epandrium. The female abdomen has a pair of small bisetose sclerites posterior to sternite 8. These bisetose sclerites are homologous with the posterior portion of sternite 8 in related taxa (e.g., *Pterogramma* Spuler, 1924 and *Robustagramma* Marshall & Cui, 2005; see Smith & Marshall 2004 and Marshall & Cui 2005) and reflect a general desclerotization of sternite 8, leaving a distinct transverse anterior portion and the paired posterior sclerites.

Measurements

Body length was measured from the anterior portion of the frons to the tip of the abdomen. Measurements were made using a Leica M2 125 with an ocular micrometer.

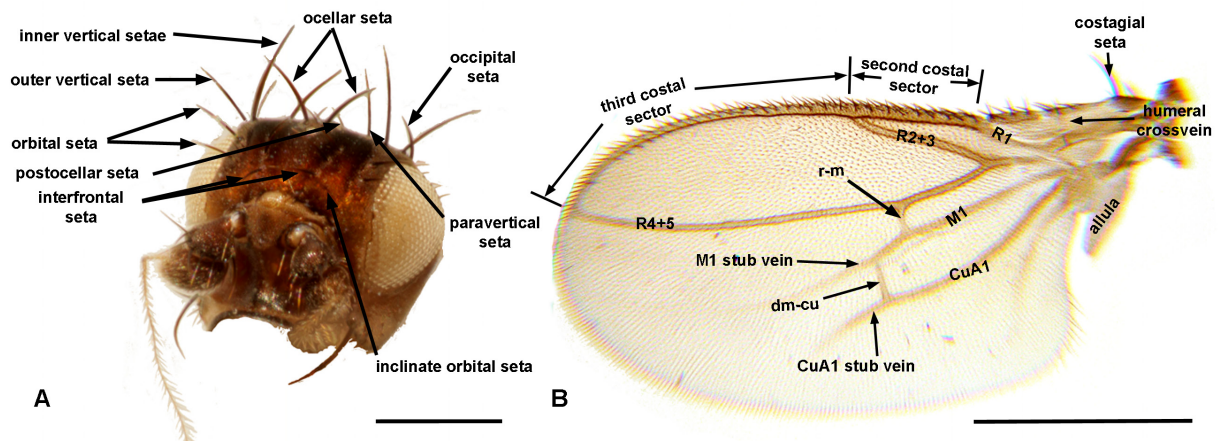

Fig. 1. **A.** *Rudolfina howdeni* sp. nov., head (debu01086104). **B.** *R. exuberata* sp. nov., wing (debu00276674). Scale bars: A = 0.20 mm; B = 0.35 mm.

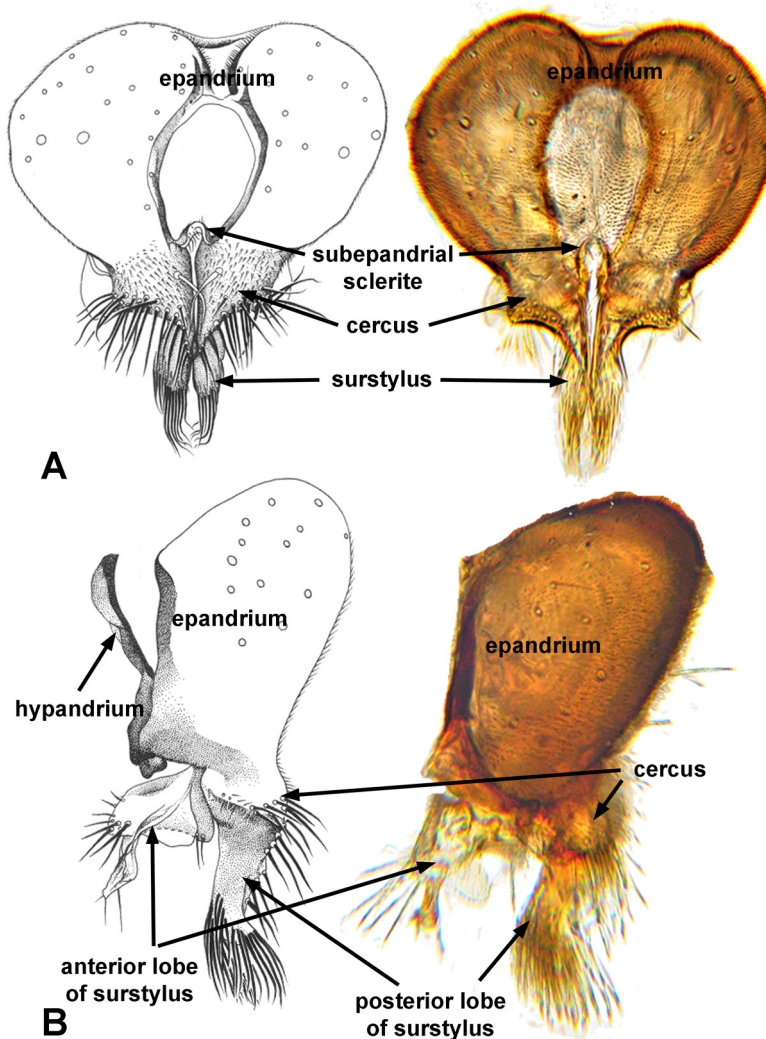

Fig. 2. *Rudolfina tumida* sp. nov. **A.** Male epandrium, cerci and surstyli, posterior view. **B.** Male epandrium, cercus and surstylus, lateral view. Illustrations and photographs from debu01086083. Scale bar: A–B = 0.10 mm.

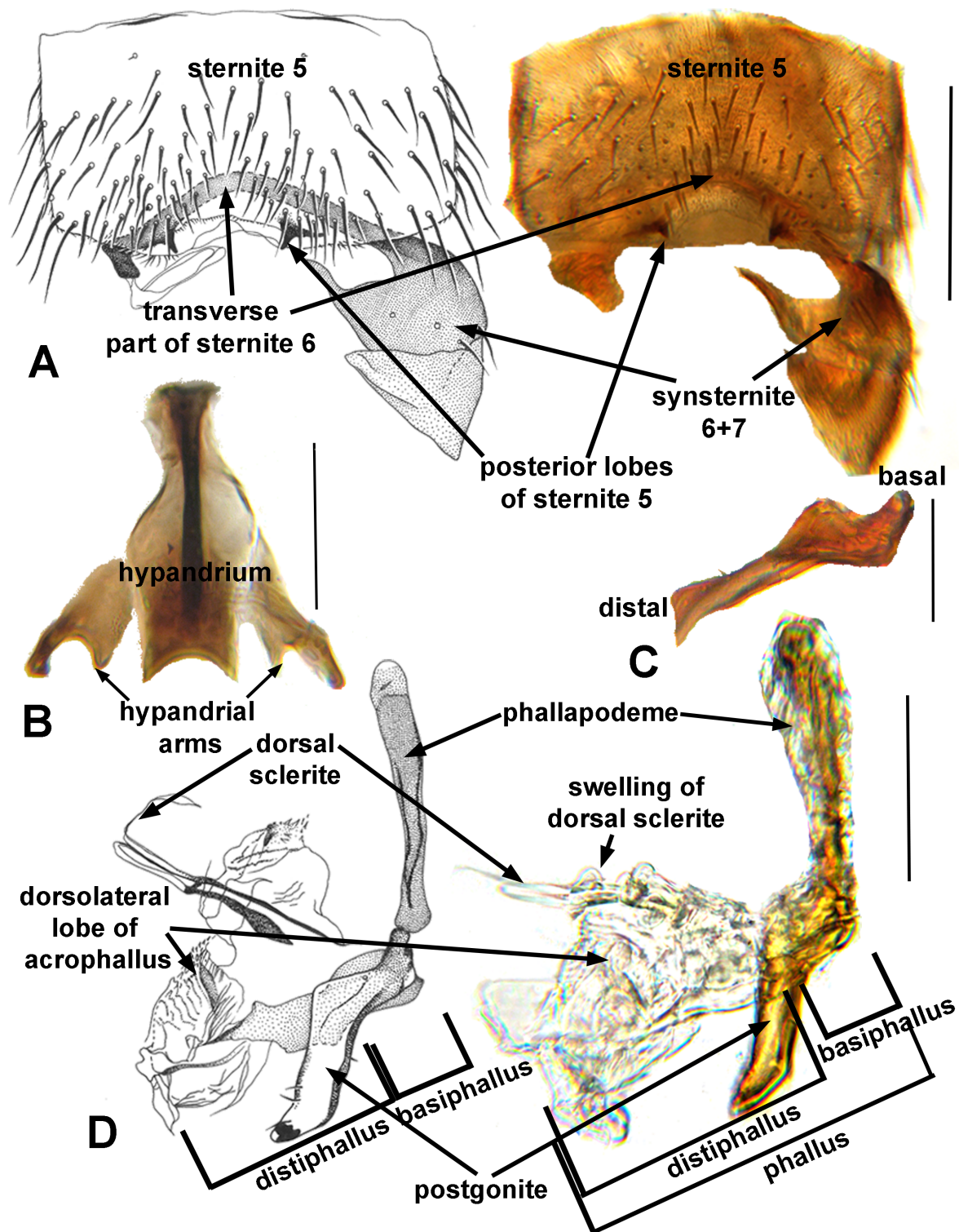

Fig. 3. Male morphology. **A.** *Rudolfina tumida* sp. nov., sternite 5, ventral view (debu01086083). **B.** *R. exuberata* sp. nov., hypandrium (debu00242299). **C.** *R. cavernicola* Marshall & Fitzgerald, 1997, postgonite, lateral view (debu01086077). **D.** *R. tumida* sp. nov., phallus (including the basiphallus and distiphallus), postgonite and phallapodeme, lateral view (debu01086083). Scale bars: A = 0.15 mm; B = 0.05 mm; C = 0.05 mm; D = 0.10 mm.

Depositories

Material examined for this study is deposited in the following institutions:

- ABSC = Archbold Biological Station, Venus, Florida, USA
- CASC = California Academy of Sciences, San Francisco, California, USA
- CNCI = Canadian National Collection, Ottawa, Ontario, Canada
- DEBU = School of Environmental Sciences, University of Guelph, Guelph, Ontario, Canada
- FMNH = Field Museum of Natural History, Chicago, Illinois, USA
- INBC = Instituto Nacional de Biodiversidad, Santo Domingo de Heredia, Costa Rica; now part of the Museo Nacional de Costa Rica

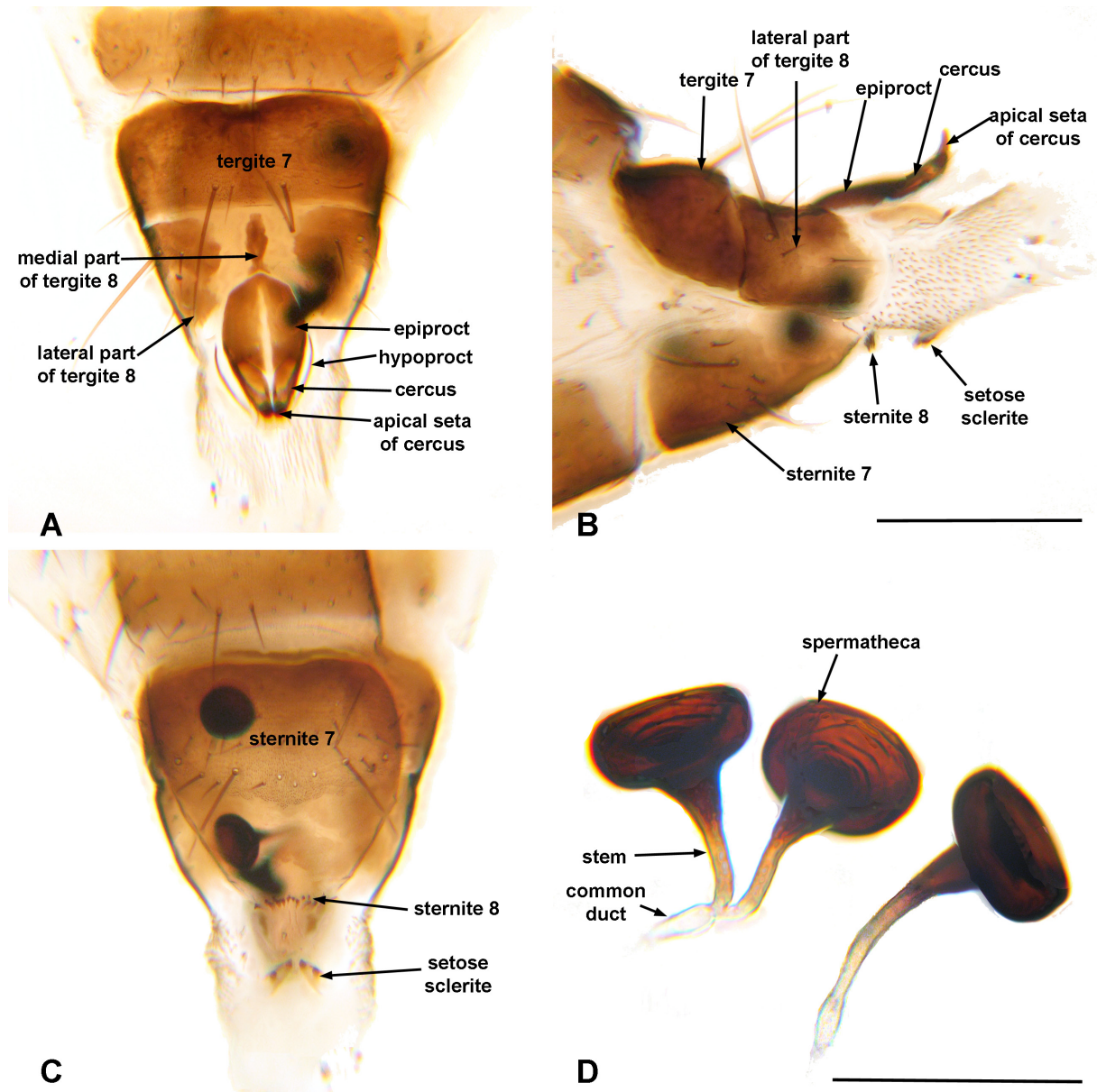

Fig. 4. *Rudolfina megepandria* sp. nov., female terminalia (debu01086086). **A.** Terminal abdominal segments, dorsal view. **B.** Same as preceding, lateral view. **C.** Same as preceding, ventral view. **D.** Spermathecae. Scale bars: A–C = 0.20 mm; D = 0.05 mm.

- MIZA = Museo del Instituto de Zoología Agrícola Francisco Fernández Yépez, Universidad Central de Venezuela, Maracay, Venezuela
MNNC = Museo Nacional de Historia Natural, Santiago, Chile
MZSP = Museu de Zoologia, Universidade de São Paulo, São Paulo, São Paulo, Brazil
NMNH = National Museum of Natural History, Smithsonian Institute, Washington DC, USA
QCAZ = Departamento de Biología, Pontífica Universidad Católica del Ecuador, Quito, Ecuador
ROME = Royal Ontario Museum, Toronto, Ontario, Canada
TAMU = Texas A&M University, College Station, Texas, USA
UASC = Museo de Historia Natural Noel Kempff Mercado, Santa Cruz de la Sierra, Bolivia
UCFC = University of Central Florida, Orlando, Florida, USA
UNAM = Universidad Nacional Autónoma de México, Mexico City, Mexico

Illustrations and photography

Microphotographs of male and female genitalia were obtained using a Canon PowerShot S51S mounted on a Leitz Laborlux 11 compound microscope. Series of images were aligned and combined using Zerene Stacker ver. 1.04 (Zerene Systems LLC, Richland, WA, USA) with the DMax algorithm. Additional editing with Adobe Photoshop CS5 (Adobe, San Jose, California, USA) was done to enhance clarity of the genitalic characters. All captions list the unique specimen identifier for the specimen(s) photographed.

Phylogenetic analysis

A character matrix (Table 1) was generated using Mesquite (ver. 3.10; Maddison & Maddison 2017) and exported for analysis in TNT (Goloboff *et al.* 2008) using Traditional Search, with 10 random seeds and 5000 replications with the tree bisection re-connection (TBR) swapping algorithm. Trees were optimized in WINCLADA (Nixon 2002).

The following 36 morphological characters used in the phylogenetic analysis are organized by body region and sex. Character states were polarized using a hypothetical groundplan similar to *R. cavernicola* Marshall & Fitzgerald, 1997 and generated based on character states in the outgroup genera *Bitheca* Marshall, 1987 and *Bromeloecia* Spuler, 1924. *Rudolfina zhangii* Su, 2017 was only recently described and no material was available for study. This species was therefore excluded from the phylogenetic analysis, although the description suggests that it is closely related to *R. rozkosnyi* Roháček, 1975, the only other Palaearctic species in the genus. Table 1 gives the character states for each species.

Character states

Head

1. Eye height:genal height ratio: (0) 1:1; (1) 1.5:1; (2) 2:1; (3) 2.5:1.

Thorax

2. Acrostichal setulae – number of rows anterior to suture: (0) 6 rows; (1) 8 rows.

Wings

3. Costagial seta length: (0) short, apex not surpassing humeral break; (1) long, apex surpassing humeral break but not reaching subcostal break; (2) very long, apex reaching or surpassing subcostal break.

Legs

4. Mid tibia (male) with apical ventral setal comb: (0) well developed; (1) reduced.
5. Mid femur (male) – ventral cluster of setae at base: (0) well developed, with 5 or more robust setae present; (1) reduced, with < 5 robust setae present.

Table 1. Character states used in the phylogenetic analysis of *Rudolfina* Roháček, 1987.

Character	01	02	03	04	05	06	07	08	09	10	11	12	13	14	15	16	17	18	19	20	21	22	23	24	25	26	27	28	29	30	31	32	33	34	35	36	
outgroup	2	0	0	0	0	0	0	0	0	0	0	0	0	0	0	0	0	0	0	0	0	0	0	0	0	0	0	0	0	0	0	0	0	0	0	0	
<i>R. bucki</i> sp. nov.	3	0	1	0	0	1	0	1	0	1	1	1	0	1	1	1	1	1	0	0	0	0	0	0	0	?	?	?	?	?	?	?	?	?	?	?	
<i>R. cavernicola</i> Marshall & Fitzgerald, 1997	2	0	1	0	0	1	1	1	0	0	1	0	0	0	0	0	0	0	0	1	1	0	0	1	1	0	0	1	1	0	0	1	0	1	0	1	
<i>R. digitata</i> Marshall, 1991	2	0	1	0	0	1	0	1	0	0	1	0	0	1	0	0	1	0	1	1	2	0	0	1	1	1	1	1	1	0	0	1	0	1	0	1	1
<i>R. exuberata</i> sp. nov.	2	1	0	1	1	1	0	2	0	0	0	0	1	1	1	1	0	1	1	0	0	0	1	0	1	1	1	1	1	0	1	1	1	1	1	1	
<i>R. howdeni</i> sp. nov.	2	0	2	0	0	1	0	1	1	0	1	0	0	1	1	1	0	1	1	0	0	0	0	0	1	1	1	1	1	1	0	1	0	1	1	1	
<i>R. megepandria</i> sp.nov.	3	0	2	0	0	1	0	1	0	1	1	0	1	1	1	0	1	1	1	0	0	0	0	0	1	1	1	1	1	0	0	1	0	1	0	1	1
<i>R. newtoni</i> sp. nov.	1	1	1	0	0	1	0	2	1	0	0	0	1	0	0	0	1	0	1	0	0	0	1	0	1	0	1	1	1	1	1	1	0	1	1	1	
<i>R. pauca</i> sp. nov.	1	1	0	0	0	1	0	2	0	0	1	0	1	1	1	1	0	1	1	0	0	1	1	0	1	1	1	1	1	0	1	1	1	1	1	1	
<i>R. pilosa</i> sp. nov.	3	0	1	0	0	1	0	2	1	0	1	0	1	0	0	1	0	1	0	0	0	1	0	0	0	?	?	?	?	?	?	?	?	?	?	?	
<i>R. remiforma</i> sp. nov.	2	0	0	1	1	1	0	1	0	0	0	0	1	1	1	1	0	1	0	0	0	0	1	0	1	1	1	1	1	0	1	1	1	1	1	1	
<i>R. rozkosnyi</i> Roháček, 1975	2	0	1	0	0	1	0	1	0	0	1	0	0	0	1	0	1	0	1	1	2	0	0	1	1	1	0	1	1	0	0	1	0	1	0	1	1
<i>R. tumida</i> sp. nov.	0	0	1	0	0	1	0	1	0	1	0	0	0	1	1	1	0	1	0	1	21	1	0	1	?	?	?	?	?	?	?	?	?	?	?	?	

Male abdomen

6. Sternite 5 – posterior lobes: (0) absent; (1) present.
7. Sternite 5 – medial process: (0) absent; (1) present.
8. Sternite 5 – depth of posteromedial emargination: (0) $< \frac{1}{4}$ length of sclerite or more; (1) $\frac{1}{3}$ – $\frac{1}{4}$; (2) $> \frac{1}{3}$. The length (depth) of the emargination is treated here as a linear transformation series.
9. Sternite 5 – clusters of setae flanking posteromedial emargination: (0) absent; (1) present.
10. Epandrium – prominence: (0) regular, equal in width to tergite 5; (1) swollen, wider than tergite 5.
11. Epandrium – subanal plate: (0) incomplete; (1) complete.
12. Subepandrial sclerite: (0) transverse; (1) arched.
13. Cercus – development: (0) well developed, prominent; (1) reduced.
14. Cercus – general shape: (0) pad-like, weakly conical; (1) elongate conical.
15. Cercus – projecting posteriorly: (0) no; (1) yes.
16. Cercus – distal seta: (0) regular; (1) robust and enlarged.
17. Surstylus – posterior lobe: (0) rounded, not projecting; (1) elongate, extending posteriorly.
18. Surstylus – flattened/modified seta on posterior surface of posterior lobe: (0) absent; (1) present.
19. Surstylus – anterobasally distinctly rounded: (0) no; (1) yes.
20. Surstylus – anterior laminate lobe well-developed: (0) no, (1) yes.
21. Surstylus – anterior laminate lobe modified: (0) no; (1) weakly modified; (2) strongly modified.
22. Postgonite – shape at mid length: (0) parallel sided; (1) narrowed.
23. Postgonite – apical morphology: (0) simple; (1) with distinct apical setula.
24. Distiphallus – dorsal sclerite with distinct swellings along length: (0) absent; (1) present.

Female abdomen

25. Median part of tergite 8: (0) absent; (1) present.
26. Median part of tergite 8 – shape: (0) wider than long; (1) longer than wide.
27. Sternite 8: (0) well developed, evenly sclerotized; (1) weakly sclerotized.
28. Bisetose sclerites posterior to sternite 8: (0) absent; (1) present.
29. Epiproct: (0) entire; (1) medially desclerotized.
30. Epiproct – anterior margin: (0) rounded; (1) straight.
31. Epiproct: (0) anteriorly truncate or rounded; (1) anteriorly produced.
32. Cercus – shape: (0) ovoid; (1) strap-like.
33. Cercus – development: (0) well-developed; (1) reduced.
34. Cercus – dorsal chaetotaxy: (0) evenly hirsute; (1) glabrous.
35. Cercus – anterolaterally fused with epiproct: (0) no; (1) yes.
36. Cercus – apical seta: (0) unmodified; (1) flattened.

Results

Genus redescription, relationships, biology, distribution and phylogeny

Class Insecta Linnaeus, 1758
Order Diptera Linnaeus, 1758
Superfamily Sphaeroceroidea Macquart, 1835
Family Sphaeroceridae Macquart, 1835
Subfamily Limosininae Macquart, 1835

Genus *Rudolfia* Roháček, 1987

Rudolfia Roháček, 1982: 225 (feminine, a junior homonym of *Rudolfia* Wilson, 1924 (Crustacea: Copepoda); type species: *Limosina rozkosnyi* Roháček, 1975, by monotypy).

Rudolfia Roháček, 1987: 474 (feminine, nom. nov. for *Rudolfia* Roháček, 1982; type species: *Limosina rozkosnyi* Roháček, 1975, automatic).

Rudolfia – Roháček 1982: 225 [formal diagnosis, phylogeny]; 1983: 152–154 [full description, phylogenetic notes]; 1987: 474 [homonymy]. — Marshall & Richards 1987: 999–1000 [diagnosis in key, illustr.].

Rudolfia – Roháček 1998: 483 [diagnosis, illustration]. — Marshall & Buck 2010: 1180–1183 [diagnosis in key, phylogenetic notes, biology]. — Su *et al.* 2017: 392–393 [key].

Redescription

BODY. Colour light to dark brown. Length 1.4–2.3 mm.

HEAD. With 3–5 interfrontal setae (of equal length or the foremost shorter), 1 (rarely 2) inclinate orbital setula and 4–10 small orbital setulae inside and below 2 strong, exclinate orbital setae; ocellar triangle with pair of strong setae and 3–5 additional small setulae; outer vertical seta strong, exclinate; inner vertical seta inclinate; occipital and paraverticilar setae inclinate, well-developed; postocellar seta inclinate, weakly developed. Eye-to-gena height ratio variable between species (1.5:1 to 3.5:1). Vibrissa strong. Gena with 1–2 strong subvibrissal setae and 4–9 smaller setulae.

THORAX. Surface pruinose. Postpronotal lobe with 2–3 setae, outer seta strong, inner seta(e) reduced. Notopleural seta, 2 supra-alar setae and prescutellar dorsocentral seta strong. Acrostichal setulae in 4–8 rows, with 1 enlarged prescutellar acrostichal seta (almost as long as dorsocentral). Katepisternum with strong elongate posterior seta and reduced anterior seta.

LEGS. Fore femur with 3–5 elongate setae dorsally (except *R. exuberata* sp. nov.). Fore tibia with 3–5 elongate setae ventrally. Mid femur with row of 3–10 anterodorsal setae extending from base, row of 2–5 dorsal setae on apical $\frac{1}{4}$, and basal cluster of 4–21 small setae ventrally; males usually with additional ventral seta (often in ventrobasal cluster). Mid tibia with 4 dorsal setae (basal anterodorsal, medial anterodorsal, distal anterodorsal and distal posterodorsal); males with ventral comb of 4–13 setae on apical $\frac{1}{2}$ or less (*R. exuberata* sp. nov. and *R. remiforma* sp. nov. with setae of ventral comb weakly developed); females usually with midventral seta (absent in *R. megepandria* sp. nov.). Hind tibia with small apical ventral spur.

WING. Always fully developed, with wing tip reaching or exceeding apex of abdomen. Costa extending to or just beyond end of R_{4+5} , and with single costagial seta $> 2.0 \times$ length of nearby setae. R_{4+5} slightly curved towards costa distally. Cell dm with short stub veins of M_1 and Cu-A1 extending beyond dm-cu. Alula narrow, posterior margin straight.

ABDOMEN. Sternites and tergites well sclerotized and setose (posterior and lateral margins more densely setose). Male sternite 4 usually simple (rarely densely setose medially).

MALE ABDOMEN. Posterior margin of sternite 5 with lobe on each side of medial emargination (shape and size of emargination and lobes vary among species). Transverse (ventral) portion of sternite 6 narrow; straight or weakly arcuate. Ring sclerite (in the right membrane of segment 7, possibly derived from a spiracle) large and distinct. Epandrium setose, often with larger setae lateral to anal opening, and with right anteroventral corner drawn out into a finger-like process that extends to the hypandrium. Male cercus usually distinct, fused with the epandrium (reduced and obscured beneath the epandrium in a few species; e.g., *R. pilosa* sp. nov., *R. remiforma* sp. nov.). Hypandrium (Fig. 3B) Y-shaped with emarginate posteromedial extension; hypandrial arms posteriorly deeply bilobed posteriorly, with lateral lobe articulating with the epandrium and the medial lobe articulating with posterolateral corner of hypandrium. Pregonite distinct, small, near anterior base of postgonite. Postgonite generally simple and slender, with 3–4 setulae on anterior margin but modified in some species; ejaculatory apodeme small and finger-like, with small globular sperm pump, usually close to the basiphallus (easily lost during dissection); basiphallus simple (without an epiphallus); distiphallus with distinct elongate dorsal sclerite; acrophallus with dorsolateral lobes and a single ventral sac (often reduced).

FEMALE ABDOMEN. Tergite 8 apparently tripartite, with two lateral triangular sclerites and a medial sclerite (reduced in several species). Epiproct bare except for usual pair of small setae and a few scattered setulae, strongly sclerotized, and fused laterally with cerci (except in *R. cavernicola*). Cercus with single flattened apical seta. Sternite 7 variable. Sternite 8 weak, transverse, covered in small setulae; pair of small, bispinose plates along posterior margin. Hypoproct very narrow, forming horseshoe-shaped band immediately below the cerci. Spermathecae (1 pair + 1 single) generally disc-shaped or lenticular, with thin, long sclerotized ducts.

Related and similar genera

All species of *Rudolfina* will key out to “*Rudolfia*” in the key to Nearctic Sphaeroceridae by Marshall & Richards (1987) but they will key out as “*Archiceroptera* genus complex, in part” at couplet 72 in the key of Marshall & Buck (2010) to Neotropical Sphaeroceridae. This previous treatment reflected uncertainty about the limits between *Rudolfina* and the many undescribed Neotropical species in the *Archiceroptera* genus complex. The *Archiceroptera* complex is part of a larger group of Limosiniinae (including *Aptilotella* Duda, 1924, *Archiceroptera* Papp, 1977, *Bitheca* Marshall, 1987, *Bromeoloecia* Spuler, 1924, *Pterogramma* Spuler, 1924 and *Robustagramma* Marshall & Cui, 2005) characterized by an unusual process extending medially from the lower right margin of the epandrium to the hypandrium. The relationships within this group need further study but the morphological analysis by Paiero (2017) suggests that *Rudolfina* is closely related to *Bromeoloecia*. Within this group, *Rudolfina* resembles *Archiceroptera* in characters of the female epiproct and cercus. However, in *Archiceroptera* the epiproct is completely desclerotized medially (anteriorly sclerotized in *Rudolfina*), the cercus is separate from the epiproct and has a partially concave inner margin, and sternite 8 is divided into a pair of elongate lateral sclerites without the paired setulose sclerites found in *Rudolfina*. *Archiceroptera* species also differ from *Rudolfina* in having M_1 extending as a pseudovein to the wing margin, CuA_1 rarely with a distinct stub vein, the male cercus free from the epandrium and with a distinct ventral process, and (in many, but not all species) five or more dorsal mid tibial setae and two or more inclinate orbital setulae.

Biology

Roháček (1987) recorded *R. rozkosnyi* from dung and occasionally from mud and decaying vegetation, but most of the new species considered here were collected in dung or carrion traps. Larvae remain unknown.

Distribution

Rudolfina has a mostly western Nearctic montane distribution, with high endemism in the southwest and the mountains of Mexico (Sierra Madre del Sur, Sierra Madre Oriental and Sierra Madre de Chiapas). Two widely separated species occur in the Palearctic region (*R. rozkosnyi* and *R. zhangii*) and one species (*R. exuberata* sp. nov.) is widespread at low elevations from the southern United States to South America. Other than *R. exuberata* sp. nov., no true species of *Rudolfina* are known from south of Guatemala. Other Neotropical species previously treated as *Rudolfina* are discussed below.

Results of the phylogenetic analysis

Twenty-seven most parsimonious trees were generated, summarized here as a strict consensus tree (Fig. 5) and a majority rules consensus tree (Fig. 6). Characters were optimized on one of the equal length trees (Fig. 7) which was selected based on the recovery of several groups supported by putatively higher weight characters. Shared male genitalic morphology supported a close relationship of *Rudolfina bucki* sp. nov. with *R. megepandria* sp. nov. and *R. tumida* sp. nov. with [*R. rozkosnyi* + *R. digitata* + *R. zhangii*]. The combined elongation of the epiproct and female cercus suggests that *R. newtoni* sp. nov. is closely related to [*R. exuberata* sp. nov. + *R. pauca* sp. nov. + *R. remiforma* sp. nov.], although the form of the epiproct in *R. newtoni* sp. nov. is apparently intermediate between the strongly elongated form found in the *R. exuberata* clade and the shorter epiproct of other *Rudolfina*. All trees recovered *R. cavernicola* as a sister taxon to the remaining species, which form a monophyletic group characterized by the fusion of the female cercus with the posterolateral corner of the epiproct, the elongation of the medial part of tergite 8 and by characters of the male cercus and surstylus. This tree suggests a New World origin for *Rudolfina*.

Within *Rudolfina* excluding *R. cavernicola*, *R. rozkosnyi*, *R. digitata* and *R. tumida* sp. nov. appear to be a basal grade predating the origin of a clade comprising the Mexican-Guatemalan species. These four

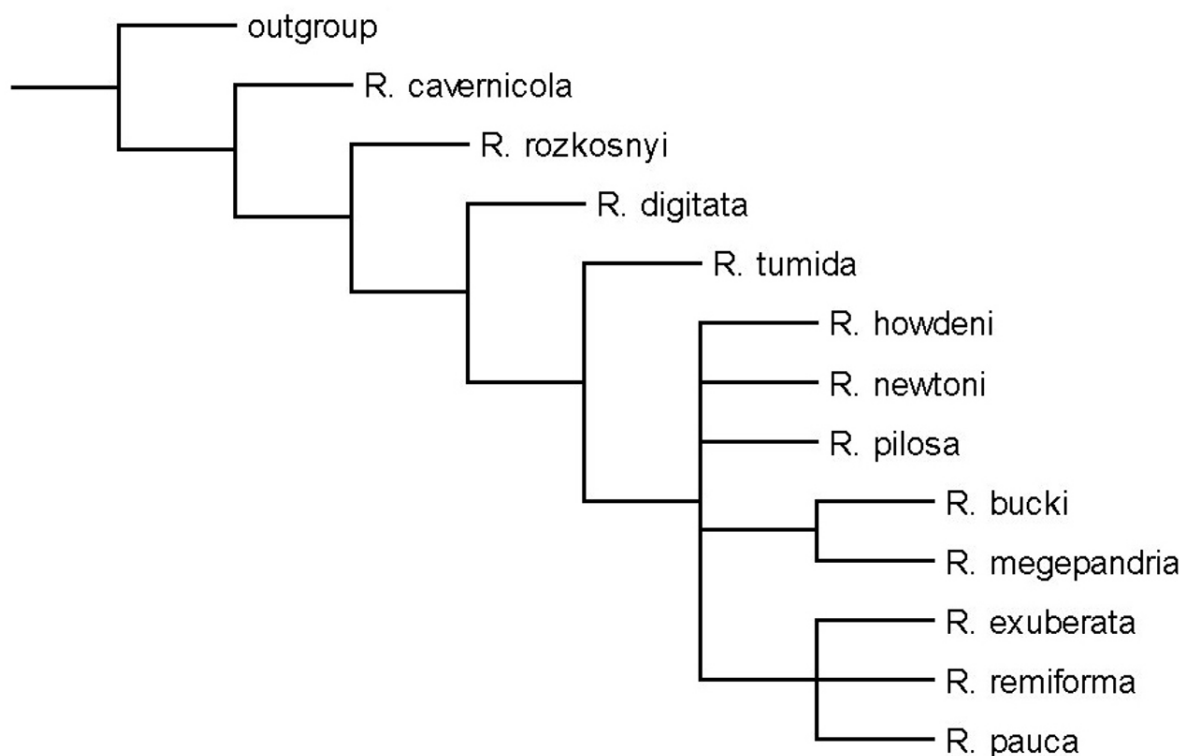

Fig. 5. Strict Consensus Tree for the 27 recovered trees obtained from Traditional Search (TNT).

species all have a laminate lobe on the surstylus, apparently derived from the simple laminate margin of *R. cavernicola* (absent in other species). The largely Mexican-Guatemalan clade can be recognized by the simple, rounded anterior lobe of the male surstylus and the absence of dorsal swellings on the dorsal sclerite of the distiphallus. The *R. exuberata* group (including *R. exuberata* sp. nov., *R. remiforma* sp. nov. and *R. pauca* sp. nov.) is characterized by a small elongate male cercus, tulip-shaped epiproct, and reduction of the female cercus. *Rudolfina remiforma* sp. nov. and *R. pauca* sp. nov. are known from only a few localities at higher elevations, as is typical of the genus, but the widespread *R. exuberata* sp. nov. occurs at much lower elevations than its more localized congeners.

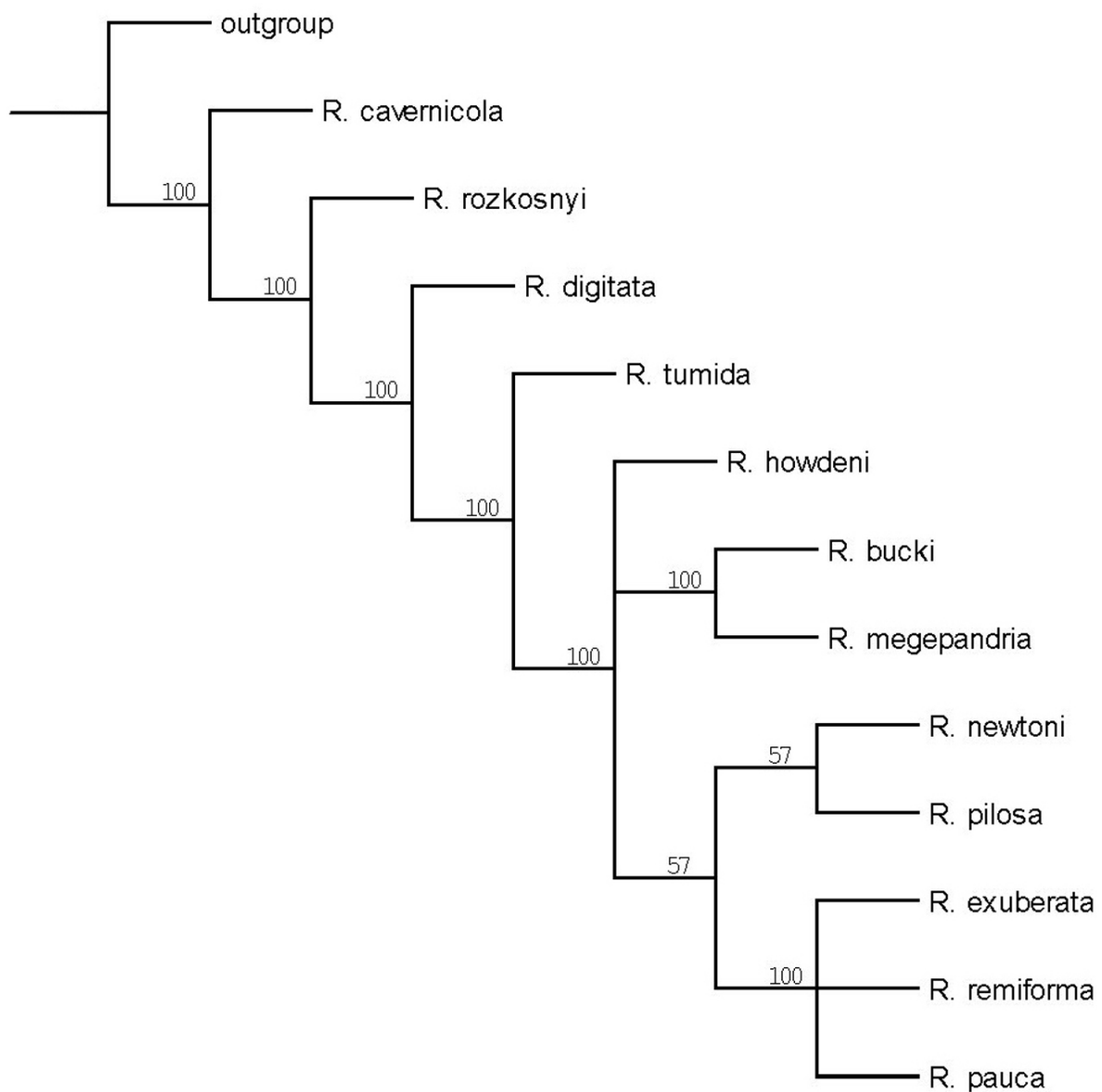

Fig. 6. Majority Rules Consensus Tree from the 27 recovered trees retained from Traditional Search (TNT).

Key to the New World *Rudolfina*

Accurate identification of species of *Rudolfina* is largely dependent on examination of male sternite 5 and genitalic characters of both sexes; dissection may be required. Females of *R. tumida* sp. nov., *R. bucki* sp. nov., *R. pilosa* sp. nov. and *R. zhangii* are unknown.

1. Males 2
 - Females 14
2. Sternite 5 with dense clusters of setae on each side of posteromedial emargination (Figs 14C, 18C) 3
 - Sternite 5 evenly setose, without distinct clusters of setae 4
3. Eye height $\sim 2.5 \times$ genal height. Sternite 4 medially with cluster of long setae (denser along posterior margin, Fig. 18C). Sternite 5 with triangular lobe on each side of triangular medial emargination on posterior margin; emargination extending anteriorly $\frac{1}{2}$ length of sternite. Surstylus (in lateral view) boot-like, with 4–6 long setae originating from median knob on posterior surface; distal $\frac{1}{3}$ evenly covered in small setulae. Postgonite with distinct apical swelling *R. pilosa* sp. nov.
 - Eye height $\sim 1.5 \times$ genal height. Sternite 4 evenly setose (Fig. 14C). Sternite 5 with small nipple-like lobe on each side of medial emargination on posterior margin; emargination extending anteriorly almost to base of sternite. Surstylus (in lateral view) strap-like, elongate and narrow; relatively bare except for small scattered setae. Postgonite simple apically, uniformly narrow *R. newtoni* sp. nov.
4. Posterior margin of sternite 5 with elongate, parallel-sided lobes (e.g., Fig. 9C) on each side of medial emargination; pair of long setulae on margin of desclerotized area adjacent to base of the lobes. Length of M_1 between crossveins dm-cu and r-m $< 1.4 \times$ dm-cu 5
 - Posterior margin of sternite 5 with an acutely angled lobe on each side of medial emargination (e.g., Fig. 19C); emargination without long setulae. Length of M_1 between crossveins dm-cu and r-m usually $> 1.5 \times$ dm-cu 6

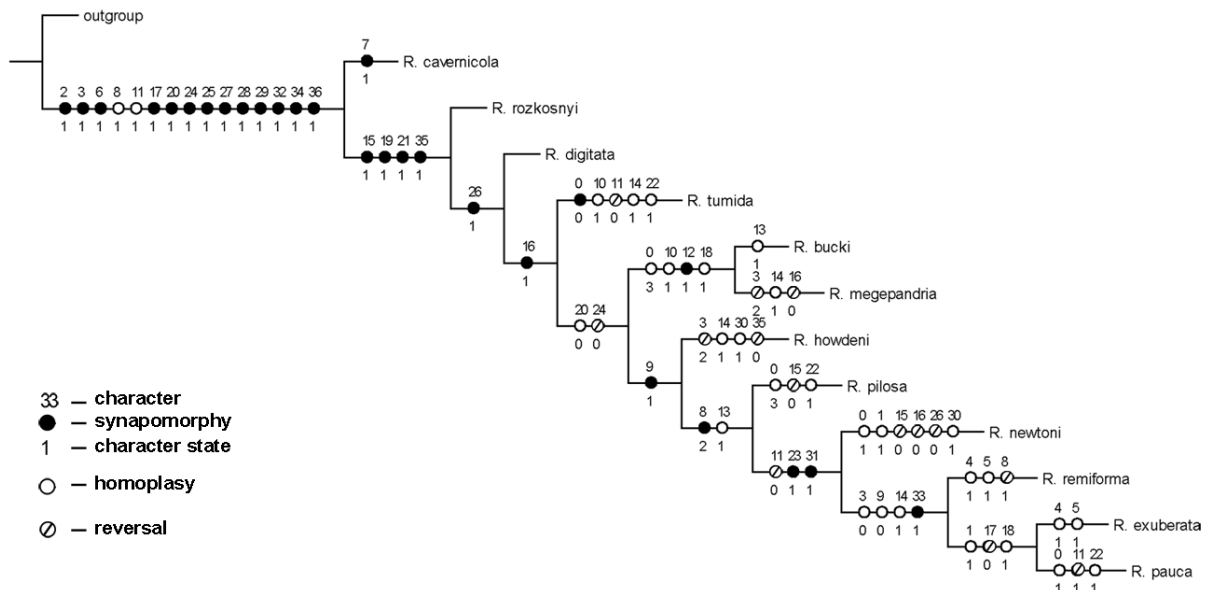

Fig. 7. Phylogeny of species of *Rudolfina* Roháček, 1987. Characters and character states refer to those given in Table 1. Tree selected from among 27 equal length trees. Length = 72, Ci = 56, Ri = 58.

5. Second costal sector $< 0.4 \times$ third costal sector. Mid tibia with ventral comb of seta weakly developed, with only 1 strong seta at midlength and 1 long preapical seta. Mid femur with single distinct ventrobasal setae *R. exuberata* sp. nov.
 – Second costal sector $\sim 0.6 \times$ third costal sector. Mid tibia with ventral comb composed of 11–13 setae on apical $\frac{1}{2}$. Mid femur with 4–5 small setae ventrobasally *R. pauca* sp. nov.
6. Sternite 5 with small medial triangular lobe (Marshall & Fitzgerald 1997: fig. 5). Surstylus strap-like, with base $\sim 1.5 \times$ as wide as distal margin; anterior margin weakly lamellate (Marshall & Fitzgerald 1997: fig. 2) *R. cavernicola* Marshall & Fitzgerald, 1997
 – Sternite 5 without medial lobe. Surstylus variable but usually with long posterior lobe and small anterior lobe 7
7. Sternite 5 with broad ($> \frac{1}{4}$ width of sternite) emargination between posterior lobes. Subanal plate complete or incomplete 8
 – Sternite 5 with small ($< \frac{1}{5}$ width of sternite) emargination between posterior lobes. Subanal plate complete 12
8. Second costal sector $\sim 0.35 \times$ third costal sector. Subanal plate narrowly complete (Fig. 19A). Sternite 5 posterior margin lateral to posterior lobes straight (Fig. 19C). Cercus elongate, small. Surstylus with long, glabrous, oar-like posterior lobe and small rounded anterior lobe with 4–5 long setae on surface *R. remiforma* sp. nov.
 – Second costal sector $0.8\text{--}1.0 \times$ third costal sector. Subanal plate broadly complete or incomplete. Sternite 5 posterior margin lateral to posterior lobes emarginate (e.g., Fig. 3A–B). Cercus ovoid, large. Surstylus with posterior lobe variable; anterior lobe complex 9
9. Eye small, height $\sim 1.0 \times$ genal height. Length of M_1 between crossveins dm–cu and r–m $\sim 4.0 \times$ dm–cu. Epandrium swollen, distinctly wider than two preceding abdominal segments (Fig. 2A). Subanal plate incomplete. Subepandrial sclerite distinctly arcuate *R. tumida* sp. nov.
 – Eye larger, height $> 1.2 \times$ genal height. Length of M_1 between crossveins dm–cu and r–m $< 2.5 \times$ dm–cu. Epandrium unmodified, as wide as two preceding abdominal segments. Subanal plate broadly complete. Subepandrial sclerite transverse 10
10. Second costal sector equal to third costal sector. Surstylus with posterior lobe elongate, with irregular pectinate anterior surface (Marshall 1991: figs 4–5) *R. digitata* Marshall, 1991
 – Second costal sector $< 1.0 \times$ third costal sector. Surstylus not as above, with posterior lobe either hoe-shaped or with 3 elongate processes 11
11. Eye height $2.0\text{--}2.3 \times$ genal height. Mid tibia distinctly arcuate in anterior view. Length of M_1 between crossveins dm–cu and r–m $\sim 1.5 \times$ dm–cu. Sternite 5 posterior margin with tips of medial lobes not reaching level of posterior margin adjacent to medial emargination (Roháček 1985: fig. 1084). Surstylus with posterior lobe hoe-shaped (Roháček 1985: fig. 1085)
 *R. rozkosnyi* Roháček, 1975
 – Eye height $\sim 1.3 \times$ genal height. Mid tibia weakly arcuate in anterior view. Length of M_1 between crossveins dm–cu and r–m $\sim 2.0 \times$ dm–cu. Sternite 5 posterior margin with tips of medial lobes extending beyond level of posterior margin adjacent to medial emargination (Su *et al.* 2017: fig. 1F). Posterior lobe of surstylus with 3 elongate projections (Su *et al.* 2017: fig. 1C)
 *R. zhangi* Su, 2017
12. Posteromedial emargination of sternite 5 with dark margin; emargination deep, extending anteriorly $\sim \frac{1}{6}$ sternite length, and nearly closed posteriorly by inwardly directed lateral lobes (Fig. 11C). Epandrium simple, not distinctly wider than preceding abdominal segments. Surstylus with anterior lobe small but well-developed, knob-like; posterior lobe elongate, clavate, with numerous long setae on distal third. Cercus clavate, almost as long as surstylus, projecting ventrally
 *R. howdeni* sp. nov.
 – Posterior emargination of sternite 5 without dark sclerotized margin; emargination shallow ($< \frac{1}{10}$ sternite length) and broadly open with short posteriorly projecting lateral lobes (Figs 8C, 13C).

- Epandrium swollen, distinctly wider than preceding abdominal segments. Surstylus with anterior lobe reduced and indistinct; posterior lobe either elongate and narrow (*R. megepandria* sp. nov.) or weakly clavate (*R. bucki* sp. nov.); setae more widely dispersed over apical ½. Cercus either elongate and projecting posteriorly, or small and not distinctly projecting 13
13. Sternite 5 with small nipple-like lobes on posterior margin; posterior margin lateral to lobes entire (Fig. 13C). Epandrium (in lateral view) with dorsal surface as long as posterior surface; setae below anal opening typical, not elongated. Surstylus with posterior lobe narrow and elongate, weakly constricted on distal ¼, with small rounded swelling near midlength. Cercus elongate, projecting posteriorly. Postgonite apically acute *R. megepandria* sp. nov.
- Sternite 5 with lobes on posterior margin triangular, obtuse; posterior margin lateral to lobes emarginate (Fig. 8C). Epandrium (in lateral view) with dorsal surface ~½ length of posterior surface; 4–6 pairs of long cruciate setae adjacent to cercus (usually obscuring cercus in caudal view). Surstylus with posterior lobe weakly clavate, with long thickened seta on posterior margin (near midlength). Cercus obscure, small, indistinct. Postgonite apically truncate ... *R. bucki* sp. nov.
14. Epiproct tulip-shaped, with narrow anterior elongation broadening near midlength into rounded posterior ‘bulb’ (Figs 10A, 17A, 20A). Length of M_1 between crossveins dm-cu and r-m $< 1.5 \times$ dm-cu. Medial portion of tergite 8 small, weakly sclerotized. Cercus shorter than flattened apical seta 15
- Epiproct triangular or trapezoidal. Length of M_1 between crossveins dm-cu and r-m $> 1.5 \times$ dm-cu. Medial portion of tergite 8 distinct, well sclerotized. Cercus as long as or longer than flattened apical seta 17
15. Sternite 7 with posterior margin entire. Spermathecae ovoid (Fig. 20D)..... *R. remiforma* sp. nov.
- Sternite 7 with posterior margin broadly emarginate (Fig. 10C). Spermatheca bilobed 16
16. Eye height $2.0 \times$ genal height. Second costal sector $< 0.5 \times$ third costal sector *R. exuberata* sp. nov.
- Eye height $2.5 \times$ genal height. Second costal sector $> 0.5 \times$ third costal sector *R. pauca* sp. nov.
17. Eye height $\sim 1.5 \times$ genal height. Medial part of tergite 8 posteromedially emarginate (Fig. 15A). Epiproct triangular. Spermathecae mushroom-shaped *R. newtoni* sp. nov.
- Eye height $\geq 1.75 \times$ genal height. Medial part of tergite 8 posteriorly entire or desclerotized. Epiproct either trapezoidal or anteriorly rounded. Spermathecae variable 18
18. Eye height $2.5 \times$ genal height. Length of M_1 between crossveins dm-cu and r-m $3.0 \times$ dm-cu. Medial part of tergite 8 elongate, rectangular (Fig. 4A) *R. megepandria* sp. nov.
- Eye height $\leq 2.3 \times$ genal height. Length of M_1 between crossveins dm-cu and r-m $2.0 \times$ dm-cu. Medial part of tergite 8 variable 19
19. Second costal sector shorter than third costal sector. Epiproct diamond-shaped, with anterolateral margins almost straight (Fig. 12A)..... *R. howdeni* sp. nov.
- Second costal sector equal in length to third costal sector. Epiproct with anterolateral margins broadly rounded 20
20. Medial part of tergite 8 wider than long, with posterior margin weakly emarginate (Marshall & Fitzgerald 1997: fig. 5). Epiproct triangular *R. cavernicola* Marshall & Fitzgerald, 1997
- Medial part of tergite 8 as long as or longer than wide; posterior margin entire. Epiproct diamond-shaped 21
21. Medial part of tergite 8 longer than wide (Marshall 1991: fig. 1). Epiproct with surface even, smooth; anterior margin broadly rounded *R. digitata* Marshall, 1991
- Medial part of tergite 8 as long as wide (Roháček 1985: fig. 1079). Epiproct with surface wrinkled on posterior half; anterior margin weakly trilobed *R. rozkosnyi* Roháček, 1975

Species descriptions (in alphabetical order)

***Rudolfina bucki* sp. nov.**

urn:lsid:zoobank.org:act:2405E619-5A06-42BB-A033-00E43C70A5B6

Figs 8, 21B

Etymology

The specific name is a patronym for Dr. Matthias Buck, a friend and previous sphaerocerid taxonomist.

Material examined

Holotype

MEXICO • ♂; Oaxaca, 4.1 mi. W of Jct. Mex. and 175-Yuvila Rd; 9300 ft a.s.l.; 8–19 Aug. 1973; A. Newton leg.; oak-fir-pine forest; FMNH debu01086238.

Paratype

MEXICO • 1 ♂; same collection data as for holotype; DEBU.

Description

Male

BODY. Length 1.6mm. Eye height $2.5 \times$ genal height. Head with 3–4 interfrontal setae and 4–5 small setae on inner margin of orbital plate. Gena with 2 strong setae and 7–8 smaller setulae. Acrostichal setulae in 4–6 rows. Costagial seta extending to midpoint between humeral and subcostal break. Second costal sector $0.7\text{--}0.8 \times$ third costal sector; length of M_1 between crossveins dm-cu and r-m $3.5 \times$ dm-cu; CuA_1 stub vein $\sim 3.0 \times$ M_1 stub vein. Male mid femur with 5–7 strong ventral setae and a circular cluster of 5–10 weaker setae ventrobasally. Male mid tibia with ventral comb of 4–5 robust setae on apical $\frac{1}{3}$, without an enlarged midventral seta.

MALE ABDOMEN (Fig. 8). Sternite 5 with pair of medial triangular lobes on posterior margin, distance between lobes $> 1.0 \times$ basal width of single lobe, lobe length $\sim \frac{1}{5}$ length of remainder of sternite. Transverse part of sternite 6 weakly arcuate. Epandrium strongly convex, with irregular cluster of 6–8 long, inclinate posterolateral setae (appearing fan-like in posterior view); subanal plate broad, complete. Surstylus with anterior lobe reduced to small basal swelling; posterior lobe elongate, clavate, weakly bent anteriorly on apical $\frac{1}{3}$; apical half of posterior lobe covered in small setae, with 1 robust elongate seta on posterior margin and 4–5 strong setae on inner surface. Cercus small, conical, with strong preapical seta. Postgonite apically truncate. Dorsal sclerite of distiphallus (Fig. 8E–G) without distinct swellings.

Female

Unknown.

Remarks

The male abdomen is similar to that of *R. megepandria* sp. nov., but males can be separated from that species by the shorter cercus and less pronounced epandrium.

***Rudolfina cavernicola* Marshall & Fitzgerald, 1997**

Fig. 21A

Material examined

The original type series from Kremmer's Cave was re-examined along with the following material.

MEXICO • 1 ♂; San Luis Potosí, Cueva de Cinquenta y Ocho, 5 km S of San Francisco, 40 km E of San Luis Potosí, Municipio de Zaraqoza; 3000 m a.s.l.; 18 May 1972; Elliott, Ralph and Lynn leg.; DEBU.

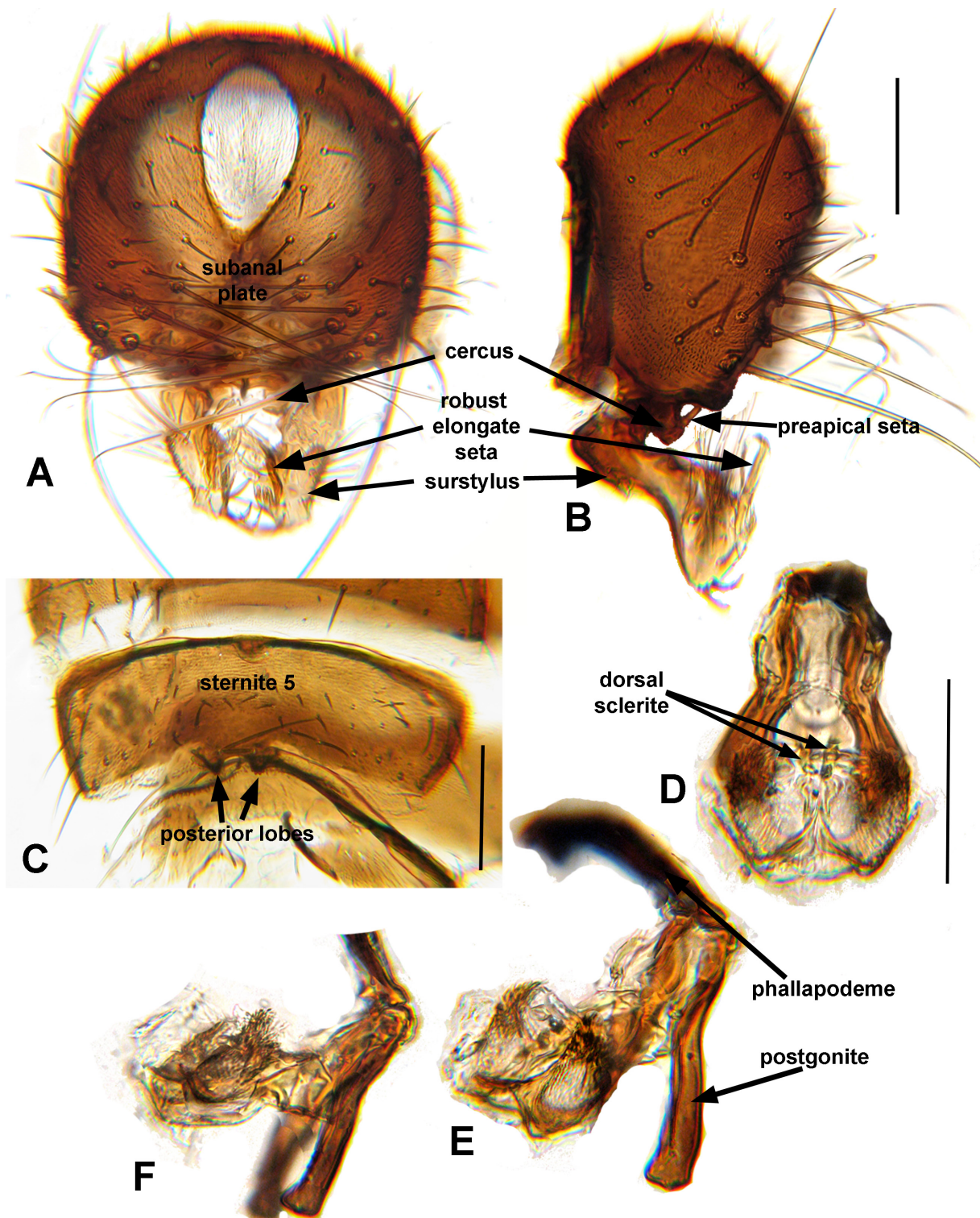

Fig. 8. *Rudolfina bucki* sp. nov., male terminalia (debu01086239). **A.** Epandrium, surstylus and cercus, caudal view. **B.** Same as preceding, lateral view. **C.** Sternite 5, ventral view. **D.** Phallus, dorsal view. **E.** Phallus, postgonite and phallapodeme, dorsolateral view. **F.** Same as preceding, lateral view. Scale bars: A–B = 0.10 mm; C = 0.10 mm; F = 0.10 mm.

Description

See Marshall and Fitzgerald 1997.

Distribution

Nearctic: United States of America (AZ, CO); Mexico (San Luis Potosí, newly recorded here).

Remarks

This species is newly recorded from Mexico. The illustration of this species that accompanied the original description (Marshall & Fitzgerald 1997: fig. 1) includes what appears to be a large seta coming off the anterior base of the surstylus; this is an unsocketed laminate lobe.

Rudolfina digitata Marshall, 1991

Fig. 21A

Material examined

In addition to the original type material, the following material was examined:

CANADA – **Alberta** • 1 ♀; Coleman; 24–26 Jul. 1980; S.A. Marshall leg.; DEBU • 1 ♀; Hailstone Butte, 60 km W of Nanton; 21–23 Jul. 1987; S.A. Marshall leg.; dung cup, under cow parsnip; DEBU. – **British Columbia** • 1 ♀; Kootenay Land District, Ainsworth, Woodbury Creek; 5 Jul. 1980; S.A. Marshall leg.; dung; DEBU • 1 ♂; Okanagan–Similkameen, Mount Kobau; 1760 m a.s.l.; 29 May–3 Jun. 1991; Blades and Maier leg.; DEBU • 1 ♂; Peace River Land District, Pink Mountain; 16 Jul. 1987; S.A. Marshall leg.; marmot dung, dwarf willow; DEBU. – **Ontario** • 1 ♀; Agnes River; Jul. 1994; A.P. Applejohn leg.; SP2, plot 18; DEBU.

MEXICO – **México** • 2 ♀♀; 3 mi. SW of Tenancingo, km 52¼; 2164 m a.s.l.; 31 Aug.–6 Sep. 1971; A. Newton leg.; oak–juniper, human dung; DEBU.

UNITED STATES OF AMERICA – **New Hampshire** • 1 ♂; Coos Co., 1 mi. NE of East Inlet Dam; 25 Jun.–9 Jul. 1986; D.S. Chandler leg.; F.I.T.; DEBU. – **New York** • 1 ♂; Greene Co., Cairo; 1 Jul. 1980; S.A. Marshall leg.; DEBU. – **Wyoming** • 2 ♂♂, 1 ♀; Sheridan Co., Antelope Butte Rec. Area, 20.3 km W of Burgess Jct.; 5–20 Aug. 1990; J.E. Swann leg.; along stream, pans, cow dung; DEBU • 1 ♂; Sheridan Co., Black Mountain, off Hwy 14; 5–20 Aug. 1990; J.E. Swann leg.; pine forest, pans, cow dung; DEBU • 2 ♂♂, 1 ♀; Sheridan Co., Black Mountain, off Hwy 14; 5–20 Aug. 1990; J.E. Swann leg.; pines, lupines, pans; DEBU • 1 ♂; Sheridan Co., Black Mountain, off Hwy 14; 5–20 Aug. 1990; J.E. Swann leg.; pines, pans, cow dung; DEBU.

Description

See Marshall (1991).

Distribution

Nearctic: Canada (AB, BC, YT, ON), U.S.A. (AK, CO, NH, NY, WY), Mexico (MEX).

Remarks

Rudolfina digitata, the second species to be described in this originally Palearctic genus, is widely distributed in western North America and also occurs in a few eastern North American sites, including Mount Washington, New Hampshire. Mount Washington is known to have other species with disjunct western Cordilleran and eastern Appalachian distributions (e.g., *Oeneis melissa* (Fabricius, 1775)

(Lepidoptera: Nymphalidae)), and the apparently disjunct population of *R. digitata* there suggests it may have once had a more extensive range. The other New Hampshire locality is also one of two known localities for the rare monotypic sphaerocerid genus *Volumosina* Roháček & Marshall, 2017, otherwise known from one old growth forest in Ontario.

The male abdomen is most similar that of the Palearctic *R. zhangi*.

Rudolfina exuberata sp. nov.

[urn:lsid:zoobank.org:act:C4509588-8528-4024-A87C-67A845A8157E](https://zoobank.org/urn:lsid:zoobank.org:act:C4509588-8528-4024-A87C-67A845A8157E)

Figs 1B, 9–10, 21D

Etymology

The specific name, which has been a manuscript name since Marshall (1982), is from the Latin for ‘abundant’: of the 1933 specimens examined for this study, 1649 were *R. exuberata* sp. nov.

Material examined

Holotype

UNITED STATES OF AMERICA • ♂; Florida, Marion Co., Ocala National Forest; 14–18 Jun. 1984; S.A. Marshall leg.; creekside, dung; DEBU debu01087005.

Paratypes

ARGENTINA • 4 ♂♂; Misiones, 5 km E of Puerto Iguazú; 2–7 Feb. 1992; S.A. Marshall leg.; FIT/pans/dung pans; DEBU.

BELIZE – **Cayo** • 4 ♂♂, 2 ♀♀; Caves Branch; 23–29 Aug. 1972; S. and J. Peck leg.: forest, dung; DEBU • 2 ♂♂; Belmopan; 26–30 Jul. 1972; S. and J. Peck leg.; palm forest, carrion; DEBU • 2 ♂♂, 3 ♀♀; San Ignacio, Maya Mountain Lodge; 17°09' N, 89°04' W; 2 Jan. 1991; S.A. Marshall leg.; *Atta* mound trail; DEBU • 1 ♂, 2 ♀♀; San Ignacio, Maya Mountain Lodge; 17°09' N, 89°04' W; 7–8 Jan. 1991; S.A. Marshall leg.; dung trap; DEBU • 1 ♂; San Ignacio, Maya Mountain Lodge; 17°9' N, 89°4' W; 7 Jan. 1991; S.A. Marshall leg.; Malaise; DEBU • 1 ♂, 11 ♀♀; Mountain Pine Ridge, Hidden Valley Inst.; 2500 ft a.s.l.; 10–15 Jan. 1991; S.A. Marshall leg.; broadleaf forest, dung traps; DEBU • 1 ♀; Mountain Pine Ridge, Hidden Valley Inst.; 2500 ft a.s.l.; 14 Jan. 1991; S.A. Marshall leg.; pine–jungle edge, sweep; DEBU • 1 ♂, 1 ♀; Mountain Pine Ridge, Hidden Valley Inst.; 2500 ft a.s.l.; 14 Jan. 1991; S.A. Marshall leg.; dung traps in pine; DEBU • 10 ♂♂, 18 ♀♀; Mountain Pine Ridge, Hidden Valley Inst.; 2500 ft a.s.l.; 10–15 Jan. 1991; S.A. Marshall leg.; grass–pine dung traps; DEBU • 3 ♂♂, 1 ♀; Beaver Dam, 39 mi. W of Belize City; 6–10 Aug. 1972; S. and J. Peck; swamp forest, dung trap; CNCI.

BOLIVIA – **La Paz** • 1 ♀; Heath River Wildlife Centre, ~21 km SSW of Puerto Heath; 12°40' S, 68°42' W; 5–7 May 2007; Marshall and Kits leg.; treefall, yellow pans; DEBU • 2 ♂♂, 1 ♀; Heath River Wildlife Research Centre; 12°40' S, 68°42' W; 5–9 May 2007; Paiero and Kits leg.; treefall, yellow pans; UASC • 1 ♀; San Antonio, ca 8 km S of Mapiri; 15°20'56" S, 68°13'31" W; 11 Apr. 2001; S.A. Marshall; secondary forest, dung pans; DEBU.

BRAZIL – **Minas Gerais** • 1 ♂, 1 ♀; 1 km E of Lavras; 18–20 Feb. 1990; S.A. Marshall leg.; dung traps in ditch; DEBU. – **Paraná** • 4 ♂♂, 2 ♀♀; Londrina; 1–2 Feb. 1990; S.A. Marshall leg.; carrion pan traps; MZSP • 2 ♂♂, 4 ♀♀; Londrina, Mata dos Godoy; 28–31 Jan. 1990; S.A. Marshall leg.; MZSP • 1 ♂, 1 ♀; 30 km SE of Curitiba, BR 277; 6–9 Feb. 1990; S.A. Marshall leg.; dung traps; DEBU. – **Rio de Janeiro** • 3 ♂♂, 1 ♀; Tijuca Forest Reserve; 1–28 Feb. 1990; S.A. Marshall leg.; Malaise; MZSP • 1 ♂; Nova Friburgo, Sítio Edelweiss; 26 Jan. 1990; S.A. Marshall leg.; Malaise; DEBU. – **São Paulo** • 1 ♂; Estación Biologica Boracea; 2 Dec. 2008; G.F.G. Miranda leg.; dung trap; MZSP • 1 ♀; Sao Paulo,

Jaragua; 8 Feb. 1990; S.A. Marshall leg.; DEBU • 8 ♂♂, 7 ♀♀; USP Biology Station; 5–6 Feb. 1979; R. Woodruff and J. Runnacles; human dung; MZSP.

CHILE • 2 ♀♀; Valparaíso, La Campana National Park; 22 Nov. 2006; S.A. Marshall leg.; MNNC.

COLOMBIA • 2 ♂♂, 2 ♀♀; N of Santander, 20 mi. S of Cucuta Quebrada de Honda; 2500 ft a.s.l.; 13–15 May 1974; S. Peck leg.; carrion trap; DEBU • 1 ♂, 1 ♀; 2 mi. N of Chinacota; 3000 ft a.s.l.; 12–14 May 1974; S. Peck leg.; carrion; DEBU.

COSTA RICA – **Alajuela** • 1 ♀; Volcán Tenorio, N slope near Bijagua Biological Station; 700 m a.s.l.; 18 Jun. 2000; Buck and Marshall leg.; pan traps in tree fall; DEBU • 1 ♀; Río Peñas Blancas; 700 m a.s.l.; 18 Aug. 1986; L. Masner; DEBU • 1 ♂; Florencia Forest; 28 Feb. 1980; H. Howden leg.; dung trap; DEBU. – **Cartago** • 7 ♂♂, 7 ♀♀; Turrialba, CATIE; 600 m a.s.l.; 26 Feb. 1980; H. and A. Howden leg.; CNCI • 6 ♂♂, 7 ♀♀; Turrialba, CATIE; 600 m a.s.l.; 26 Feb. 1980; H. and A. Howden leg.; INBC • 6 ♂♂, 9 ♀♀; Turrialba, CATIE; 600 m a.s.l.; 28 Feb. 1980; H. and A. Howden leg.; DEBU • 1 ♂; Turrialba, CATIE, Florence Forest; 600 m a.s.l.; 28 Feb. 1980; H. and A. Howden leg.; cup traps; DEBU. – **Guanacaste** • 1 ♂; Guanacaste Conservation Area, Pitilla Field Station; 29 Jan. 1996; J. Noyes leg.; Malaise; DEBU. – **Heredia** • 1 ♀; La Selva; 2 Feb. 1990; N. Grieg leg.; around dung ball rolled by *Canthon moniliatus* Bates, 1887; DEBU. – **Limón** • 4 ♀♀; Estrella Valley, Pandora; 20 Feb. 1984; H. Howden leg.; carrion trap; CNCI • 1 ♂, 1 ♀; 4 km NE of Bribri; 50 m a.s.l.; Dec. 1989–Mar. 1990; P. Hanson leg.; INBC.

CUBA • 1 ♀; Santiago, Gran Piedra Meteorological Radar; 1100 m a.s.l.; 6–17 Dec. 1995; S. Peck leg.; elfin forest, carrion traps; DEBU.

ECUADOR – **Napo** • 2 ♂♂; Tiputini Biodiversity Station, vicinity Yasuní National Park; 0°38' S, 76°0' W; 14–19 Feb. 1998; D.C. Darling leg.; human dung pitfalls; DEBU • 1 ♀; Yasuní National Park, Yasuní Research Station; 0°38' S, 76°36' W; 3–20 Nov. 1998; Pape and Viklund leg.; rain forest, Malaise trap; DEBU • 4 ♀♀; Jatun Sacha Reserve, 6 km E of Misahuallí; 1°04' S, 77°37' W; 450 m a.s.l.; 30 Apr.–7 May 2002; Buck *et al.* leg.; landslide in forest, Malaise trap; QCAZ • 2 ♂♂; Tena; 500 m a.s.l.; 21–27 May 1987; Brown and Coote leg.; secondary rainforest, Malaise head; DEBU • 3 ♂♂; 12 km SW of Tena; 500 m a.s.l.; 8–11 Aug. 1976; S. Peck leg.; dung trap; QCAZ • 1 ♂; S side of Río Piocullin, SW Puerto Napo, S of Limonchicta; 600 m a.s.l.; 23–27 May 1987; primary lowland rainforest, Malaise head; ROME. – **Pichincha** • 8 ♂♂, 8 ♀♀; Río Palenque Station, 47 km S of Santo Domingo; 250 m a.s.l.; 17–25 Feb. 1979; S.A. Marshall leg.; dung; DEBU • 7 ♂♂, 3 ♀♀; Río Palenque Station, 47 km S of Santo Domingo; 250 m a.s.l.; 17–25 Feb. 1979; S.A. Marshall leg.; QCAZ • 1 ♂; Río Palenque; 25 Feb. 1979; S.A. Marshall leg.; carrion; QCAZ • 1 ♀; Río Palenque; 27 Feb. 1979; S.A. Marshall leg.; carrion; DEBU • 1 ♂; Palenque; 24–25 Feb. 1975; S. Peck leg.; day 3, trap 35; DEBU • 13 ♂♂, 23 ♀♀; Río Palenque; 25 Feb. 1979; S.A. Marshall leg.; dung; DEBU • 4 ♂♂, 17 ♀♀; Río Palenque; 27 Feb. 1979; S.A. Marshall leg.; dung; DEBU • 5 ♂♂, 17 ♀♀; Río Palenque; 27 Feb. 1979; S.A. Marshall leg.; dung; QCAZ • 1 ♂; Río Palenque; 22–23 Feb. 1976; S. Peck leg.; dung trap; DEBU • 1 ♂; Río Palenque; 25–26 Feb. 1976; S. Peck leg.; dung trap; DEBU • 1 ♂; Río Palenque; 22 Feb. 1976; S. Peck leg.; DEBU.

GUATEMALA – **Baja Verapaz** • 2 ♂♂, 2 ♀♀; 6.6 km W of Chilasco; 1700 m a.s.l.; 30 May 1991; H. Howden leg.; dung; DEBU. – **Guatemala** • 1 ♂, 1 ♀; Santa Catarina Pinula; 1840 m a.s.l.; 11–13 Jun. 1991; B.D. Gill leg.; dung traps; DEBU. – **Petén** • 11 ♂♂, 7 ♀♀; Tikal; 28–30 Jul. 1978; Helava and Kukal leg.; dung trap; DEBU. – **Sacatepéquez** • 1 ♀; 5 km SE of Antigua; 14°32'14" N, 90°41'41" W; 2125 m a.s.l.; 10–13 Jun. 2009; hardwood forest, Malaise trap; DEBU. – **Zacapa** • 1 ♂; 3.5 km SE of La Unión; 1500 m a.s.l.; 26 Jun. 1993; R. Anderson leg.; cloud forest litter; DEBU • 3 ♀♀; same collection data as for preceding; 25–27 Jun. 1993; Ashe and Brooks leg.; FIT #128; DEBU.

GUYANA – **Mazaruni-Potaro** • 1 ♀; Takutu Mountains; 6°15' N, 58°55' W; 8–10 Dec. 1983; Perkins and Steiner leg.; window trap in montane rainforest near logging area; DEBU. – **Potaro-Siparuni** • 1 ♀; Mount Wokomung; 5°06'35" N, 59°49'15" W; 1234 m a.s.l.; 27 Oct.–1 Nov. 2004; B. Hubley leg.; primary rainforest, human dung, pitfall trap; ROME. – **Rupununi** • 3 ♂♂, 4 ♀♀; Kurupukari, Essequibo River; 200 ft a.s.l.; 9 Oct. 1990; B. Hubley leg.; primary forest, dung traps; ROME • 1 ♂, 1 ♀; Kabocalli, Iwokrama Forest Res.; 60 m a.s.l.; 3–5 Jun. 2001; Brooks and Falin leg.; FIT; DEBU.

HONDURAS • 1 ♀; Olancho; 23 May 1995; R. Cordire leg.; FIT; DEBU.

MEXICO – **Campeche** • 3 ♂♂, 1 ♀; Chicanna, 10 km W of Xbuzi; 300 m a.s.l.; 12–14 Jul. 1983; S. and J. Peck leg.; tropical seasonal forest, carrion traps; CNCI • 4 ♂♂, 2 ♀♀; Chicanna, 10 km W of Xbuzi; 300 m a.s.l.; 12–14 Jul. 1983; S. and J. Peck leg.; tropical seasonal forest, carrion traps; UNAM • 3 ♂♂, 7 ♀♀; 53 mi. E of Escárcega; 500 ft a.s.l.; 8–14 Aug. 1971; A. Newton leg.; tropical semi-evergreen, dung; DEBU • 3 ♂♂, 7 ♀♀; same collection data as for preceding; FMNH • 7 ♂♂, 9 ♀♀; 87 mi. E of Escárcega; 800 ft a.s.l.; 8–14 Aug. 1971; A. Newton leg.; semi-evergreen, human dung; DEBU • 10 ♂♂, 14 ♀♀; same collection data as for preceding; UNAM • 2 ♂♂, 2 ♀♀; same collection data as for preceding; FMNH. – **Chiapas** • 2 ♀♀; 21 mi. N of Bochil; 5500 ft a.s.l.; 18–24 Aug. 1971; A. Newton leg.; pine, oak, *Liquidambar* L., human dung; DEBU • 1 ♀; 4 km SE of Custepec; 15°42'30" N, 92°55'51" W; 2100 m a.s.l.; 20 May 2008; cloud forest, Malaise trap; DEBU • 2 ♀♀; Playón de la Gloria; 16°08'53" N, 90°53'48" W; 180 m a.s.l.; 25 May 2008; mature wet forest, Malaise trap; UNAM • 1 ♀; Playón de la Gloria; 16°09'37" N, 90°54'7" W; 160 m a.s.l.; 25 May–24 Jun. 2008; mature wet forest, Malaise trap; UNAM • 2 ♂♂, 4 ♀♀; 8 km SE of Salto de Agua; 17°30'45" N, 92°17'40" W; 60 m a.s.l.; 14–17 Jun. 2008; secondary wet forest, Malaise trap; UNAM • 2 ♀♀; 8 km SE of Salto de Agua; 17°30'58" N, 92°18'05" W; 100 m a.s.l.; 14 Jun. 2008; wet forest edge, Malaise trap; UNAM • 5 ♂♂, 8 ♀♀; Palenque; 100 m a.s.l.; 6–9 Jul. 1983; S. and J. Peck leg.; rainforest, carrion trap; DEBU • 1 ♀; Parque Nacional Sumidero; 1000 m a.s.l.; 1 Jun. 1990; H. and A. Howden leg.; CNCI • 1 ♂, 2 ♀♀; 15 mi. NW of Ocozocoautla; 2800 ft a.s.l.; A. Newton leg.; rainforest, dung; DEBU • 5 ♂♂, 2 ♀♀; 11 mi. NW of Ocozocoautla; 3400 ft a.s.l.; 19–25 Aug. 1971; A. Newton leg.; oak-evergreen forest, human dung; FMNH • 6 ♂♂, 4 ♀♀; 4 mi. S of Palenque; 600 ft a.s.l.; 7–15 Aug. 1971; A. Newton leg.; rainforest, human dung; DEBU • 10 ♂♂, 10 ♀♀; same collection data as for preceding but 700 ft a.s.l.; DEBU • 11 ♂♂, 10 ♀♀; same collection data as for preceding; FMNH • 1 ♂; Palenque; 80 m a.s.l.; 2–23 Jul. 1983; S. and J. Peck leg.; secondary vegetation; FIT; DEBU • 1 ♂; Laguna Belgica, 16 km NW of Ocozocoautla; 970 m a.s.l.; 13 Jun. 1990; H. and A. Howden and B. Gill leg.; F.I.T.; DEBU. – **Guerrero** • 1 ♂, 1 ♀; 9 mi. NE of Iguala; 4400 ft a.s.l.; 29 Aug.–4 Sep. 1971; A. Newton leg.; deciduous forest, human dung; FMNH. – **Oaxaca** • 5 ♂♂, 9 ♀♀; 5 mi. S of Valle Nacional; 1600 ft a.s.l.; 20 Jul.–1 Aug. 1971; A. Newton leg.; tropical-oak-evergreen, dung; DEBU • 3 ♂♂, 2 ♀♀; 12 mi. S of Valle Nacional; 3200 ft a.s.l.; 22–31 Jul. 1971; A. Newton leg.; tropical montane forest, shrimp carrion; DEBU. – **Pueblo** • 1 ♂; 1 mi. S of Honey; 6800 ft a.s.l.; 1–6 Aug. 1971; A. Newton leg.; *Pinus* L., *Quercus* L., human dung; DEBU. – **Tabasco** • 6 ♂♂, 5 ♀♀; 46 mi. SE of Villa Hermosa, km74; 150 ft a.s.l.; 8–15 Aug. 1971; A. Newton leg.; secondary veg. rainforest, human dung; FMNH. – **Tamaulipas** • 8 ♂♂, 17 ♀♀; Municipio Casas, 47 mi. E of Ciudad Victoria; Nov.–Dec. 1986; R. Jones leg.; carrion pitfall trap; TAMU. – **Veracruz** • 1 ♂; 33 km NE of Catemaco, Los Tuxtlas Biological Station; 160 m a.s.l.; 6 Jul.–1 Aug. 1983; S. Peck leg.; ridge rainforest, FIT; DEBU • 2 ♂♂, 4 ♀♀; Fortin, SW of Rio Metlas; 3250 ft a.s.l.; 13–18 Jul. 1971; A. Newton leg.; human dung, FMNH • 3 ♂♂, 2 ♀♀; 10 mi. SW of Teocelo; 4400 ft a.s.l.; 11 Jul. 1971; A. Newton leg.; oak, wet, human dung, FMNH • 7 ♂♂, 4 ♀♀; 8 mi. NNW of Sontecomapan; Jul.–Aug. 1971; A. Newton leg.; rainforest, dung; DEBU. – **Yucatán** • 1 ♀; 9 mi. SE of Santo Roso, km 137¼; 100 ft a.s.l.; Aug. 1971; A. Newton leg.; tropical sub-deciduous forest, human dung; DEBU.

PARAGUAY – **Caazapá** • 18 ♂♂, 12 ♀♀; Hermosa, San Rafael Reserve, prop. Lopez family; 26°18'29" S, 55°45'03" W; 80 m a.s.l.; 1–3 Dec. 2000; Z.H. Falin leg.; FIT; DEBU • 2 ♂♂, 1 ♀; Hermosa, San Rafael Reserve, prop. Lopez family; 26°19'15" S, 55°44'55" W; 90 m a.s.l.; 3–6 Dec. 2000; Z.H. Falin leg.; FIT; DEBU. – **Itapúa** • 1 ♀; Karonay, 17 km W of San Rafael Reserve; 26°45'53" S, 55°50'37" W; 90–110 m a.s.l.; 18–21 Nov. 2000; Z.H. Falin leg.; FIT; DEBU.

PERU – **Junín** • 2 ♀♀; Pampa Hermosa lodge, 22 km N of San Ramón; 10°59'18" S, 75°25'30" W; 1220 m a.s.l.; 24–27 Nov. 2007; D. Brzoska leg.; FIT; DEBU. – **Cusco** • 1 ♀; Cock-of-the-Rock Lodge, NE of Paucartambo; 13°03'18" S, 71°32'42" W; 1120 m a.s.l.; 4–9 Nov. 2007; D. Brzoska leg.; FIT; DEBU. – **Lima** • 1 ♂; Huaral, Chancay; 15 Mar. 1951; Ross and Michelbacher leg.; river valley; CASC. – **Loreto** • 1 ♂; Teniente López; 24 Jul. 1993; R. Leschen leg.; FIT; DEBU. – **Madre de Dios** • 3 ♂♂, 3 ♀♀; Zona Reserva Manu, Pakitza; 11°57' S, 71°17' W; 400 m a.s.l.; 13–18 Feb. 1992; B. Brown and D. Feener leg.; Malaise trap; DEBU • 3 ♀♀; Pantiacolla Lodge, Alto Madre de Dios River; 12°39'18" S, 71°13'54" W; 420 m a.s.l.; 14–19 Nov. 2007; D. Brzoska leg.; FIT; DEBU. 4 ♂♂, 5 ♀♀; Amazonas Lodge, N of Atalaya; 12°52'12" S, 71°22'36" W; 480 m a.s.l.; 10–13 Nov. 2007; D. Brzoska leg.; FIT; DEBU • 1 ♀; Los Amigos Biological Station; 3–13 Jun. 2006; Paiero and Klymko leg.; Malaise; DEBU.

TRINIDAD AND TOBAGO – **Tobago** • 1 ♂; 10 km NE of Roxborough, Gilpin Trail; 450 m a.s.l.; 26–30 Jun. 1993; S. and J. Peck leg.; rainforest, carrion traps; DEBU. – **Trinidad** • 1 ♂; University of Santa Cruz, Gasparillo; 15 Nov. 1987; R. Borneo leg.; grassland/forest edge, Malaise trap; DEBU.

UNITED STATES OF AMERICA – **Alabama** • 22 ♂♂, 32 ♀♀; Baldwin Co., Bon Secour National Wildlife Refuge; 30°14'48" N, 87°49'45" W; 5–7 Jun. 1994; S.A. Marshall leg.; dung traps in oak; DEBU • 2 ♀♀; same collection data as for preceding; 5–7 May 1994; S.A. Marshall leg.; mushroom trap on oak; DEBU • 2 ♂♂; Jackson Co., Paint Rock; 7–13 Jul. 1973; S. Peck leg.; dung; DEBU. – **Arkansas** • 1 ♂; Johnson Co., Haw Creek Falls; 22 May 1991; B.J. Sinclair leg.; DEBU • 1 ♂, 2 ♀♀; Logan Co., Ozark National Forest, Magazine Mountain; 23 May 1991; J.E. Swann leg.; mushroom baited pans; DEBU • 2 ♀♀; Madison Co., 3 mi. S of Brashers; 1600 ft a.s.l.; 19 Jun.–12 Jul. 1972; A. Newton leg.; hardwood forest, dung; DEBU • 1 ♂; Polk Co., Rich Mountain, 13 mi. NW of Mena; 2800 ft a.s.l.; 1–3 Jun. 1979; S. and J. Peck leg.; mesic oak-hickory; DEBU • 4 ♂♂, 3 ♀♀; Washington Co., 3 mi. S of Devils Den State Park; 28–31 May 1979; S. and J. Peck leg.; oak-hickory; DEBU • 1 ♂, 3 ♀♀; Washington Co., Devils Den State Park, Devils Den Cave; 28–31 May 1979; S. and J. Peck leg.; DEBU. – **Florida** • 1 ♀; Alachua Co., Gainesville; 20–30 Nov. 1986; W.R.M. Mason leg.; hardwood forest, Malaise trap; DEBU • 1 ♀; Alachua Co., Rd 176; 10 May 1983; K.W. Vick leg.; carrion trap; DEBU • 1 ♀; Alachua Co., Gainesville, DPI; 25–27 May 1983; D.S. Chandler leg.; Malaise trap; DEBU • 1 ♀; Alachua Co., High Springs; 15–16 Dec. 1999; S.A. Marshall leg.; on dung; DEBU • 1 ♀; Alachua Co., Gainesville; 12 Oct. 1976; Choate and Woodruff leg.; DEBU • 16 ♂♂, 29 ♀♀; Alachua Co., Gainesville, Hogtown Creek; 12 Oct. 1976; Choate and Woodruff leg.; DEBU • 2 ♂♂, 5 ♀♀; Clay Co., Gold Head Branch State Park; 4–14 Apr. 1971; A. Newton leg.; carrion; DEBU • 2 ♂♂, 1 ♀; Clay Co., Gold Head Branch State Park; 14 Apr. 1971; A. Newton leg.; dung; DEBU • 1 ♀; Collier Co.; 28 Dec. 1979; S.A. Marshall leg.; DEBU • 3 ♀♀; Collier Co., Collier Seminole State Park; Apr. 1971; A. Newton; pine, palm, human dung; UCFC • 1 ♂, 6 ♀♀; Dade Co., Everglades National Park, 1.5 km NW of Royal Palm; 1 Nov. 1984–3 Mar. 1985; S. and J. Peck leg.; hardwood hammock forest, Malaise-FIT; UCFC • 7 ♀♀; same collection data as for preceding but 15 Nov. 1985–24 Feb. 1986; DEBU • 3 ♂♂, 4 ♀♀; same collection data as for preceding but 2 May–2 Aug. 1985; DEBU • 5 ♀♀; Dade Co., Chekika State Recreation Area, 50 km SW of Miami, Grossman Hammock Forest; 1 May–2 Aug. 1985; S. and J. Peck leg.; Malaise-FIT; DEBU • 1 ♀; De Land Co., Hwy. 40, near Barberville; 18–20 Jun. 1984; S.A. Marshall leg.; mushroom trap; DEBU • 1 ♂, 1 ♀; Hendry Co., La Belle, Captain Hendry Rd; Apr. 1971; pine, hardwood near river, human dung; A. Newton leg.; DEBU • 1 ♂, 3 ♀♀; Hernando Co., Withlacoochee State Forest, 1 mi. W of Croom; Apr. 1971, A. Newton leg.; pine and hardwood, human dung; DEBU •

1 ♂; Hernando Co., 1 mi. W of Croom; Apr. 1971; A. Newton leg.; mixed forest; DEBU • 1 ♀; Highlands Co., Archbold Biological Station; 12–18 Dec. 1985; S.A. Marshall leg.; mushroom bait on sand; ABSC • 2 ♂♂, 6 ♀♀; same collection data as for preceding but 17–21 Dec. 1985; scrub, dung; ABSC • 2 ♀♀; same collection data as for preceding but 12–16 Dec. 1985; scrub, dung pitfall; DEBU • 1 ♂; same collection data as for preceding; scrub-sand, dung pan; DEBU • 6 ♂♂, 12 ♀♀; same collection data as for preceding but 15–19 Dec. 1985; dung pan; DEBU • 1 ♂, 1 ♀; Highlands Co., Lake Placid, north shore; 14–16 Dec. 1985; S.A. Marshall leg.; palmetto, dung trap; DEBU • 3 ♂♂ 8 ♀♀; Highlands Co., Highlands Hammock State Park, Cypress Swamp; 15–21 Dec. 1985; S.A. Marshall leg.; dung pan; DEBU • 1 ♂; Highlands Co., Highland Hammock State Park; 13–17 Apr. 1989; S.A. Marshall leg.; pans/maggot bait; DEBU • 1 ♂, 6 ♀♀; same collection data as for preceding but 14–18 Jun. 1982; Woodruff and Rench leg.; orange grove, pig dung; UCFC • 30 ♂♂, 41 ♀♀; Lake Co., 1 mi. W of Howey-in-the-Hills; Apr. 1971; A. Newton leg.; mixed hardwood forest, human dung; DEBU • 5 ♂♂, 5 ♀♀; Lake Co., Howey-in-the-Hills; Apr. 1971; A. Newton leg.; dung; CASC • 5 ♂♂, 5 ♀♀; same collection data as for preceding; CNCI • 5 ♂♂, 5 ♀♀; same collection data as for preceding; NMNH • 1 ♂, 8 ♀♀; Liberty Co., Torreya State Park; 6 Jun. 1982; R.E. Woodruff leg.; pig dung trap; DEBU • 5 ♂♂, 6 ♀♀; Marion Co., Ocala National Forest; 14–18 Jun. 1984; S.A. Marshall leg.; creekside, dung; DEBU • 10 ♂♂, 10 ♀♀; same collection data as for preceding; FMNH • 10 ♂♂, 10 ♀♀; same collection data as for preceding; CNCI • 3 ♂♂, 6 ♀♀; same collection data as for preceding but 11–15 Jun. 1984; hardwood swamp, dung trap; DEBU • 2 ♂♂, 2 ♀♀; Marion Co., Ocala National Forest; 8–11 Jun. 1984; S.A. Marshall leg.; oak grove, mushroom trap; DEBU • 3 ♂♂, 4 ♀♀; Marion Co., Ocala National Forest; Apr. 1971; A. Newton leg.; dung; CNCI • 3 ♂♂, 3 ♀♀; same collection data as for preceding; NMNH • 3 ♂♂; Marion Co., Ocala National Forest, near Lynne; 20–24 Jun. 1984; S.A. Marshall leg.; palm–oak, dung trap; DEBU • 3 ♂♂, 12 ♀♀; Marion Co., Ocala National Forest, Oklawaha Swamp; 11–12 Jun. 1984; S.A. Marshall leg.; dung trap; DEBU • 2 ♀♀; Marion Co., Ocala National Forest, Road 65; 18–20 Jun. 1984; S.A. Marshall leg.; sand–pine, human dung; DEBU • 1 ♂, 6 ♀♀; Marion Co., Ocala National Forest, Road 65, 1.5 mi. W of State Road 19; 15–16 Mar. 1984; R.E. Woodruff leg.; dung; DEBU • 1 ♂; Marion Co., Ocala National Forest, Silver Springs Woods; 6–23 Jun. 1984; S.A. Marshall leg.; oak, FIT; DEBU • 1 ♀; Marion Co., Ocala National Forest, Silver Springs Woods; 12–14 Jun. 1984; S.A. Marshall leg.; sand–pine; human dung; DEBU • 2 ♂♂; Marion Co., Ocala National Forest, Silver Springs Woods; 11–15 Jun. 1984; S.A. Marshall leg.; carrion FIT; DEBU • 1 ♂, 1 ♀; same collection data as for preceding but 6–22 Jun. 1984; FIT; DEBU • 2 ♀♀; same collection data as for preceding but 10–15 Jun. 1984; DEBU • 1 ♂; Marion Co., Ocala National Forest, Zay Prairie; 14–18 Jun. 1984; S.A. Marshall leg.; carrion trap; DEBU • 7 ♂♂, 17 ♀♀; Marion Co., Route 316, nr Eureka; 15–16 Mar. 1984; R.E. Woodruff leg.; pig dung trap; DEBU • 1 ♂; Monroe Co., Everglades National Park, Royal Palm Hammock; 1 Nov. 1984–3 Mar. 1985; S. and J. Peck leg.; hammock forest, Malaise-FIT; DEBU • 6 ♂♂, 10 ♀♀; Nassau Co., golf course nr Amelia; 3–15 Apr. 1971; A. Newton leg.; oak forest, dung; NMNH • 2 ♂♂, 6 ♀♀; same collection data as for preceding; DEBU • 6 ♂♂, 10 ♀♀; Nassau Co., Jacksonville, Cary State Forest; 10–18 Apr. 1989; Marshall and Swann leg.; dead squirrel, pan trap; DEBU • 11 ♂♂, 10 ♀♀; Nassau Co., nr Amelia; 3–15 Apr. 1971; A. Newton leg.; dung; NMNH • 8 ♂♂, 6 ♀♀; same collection data as for preceding; DEBU • 1 ♂, 1 ♀; Okaloosa Co., Blackwater River National Forest, 1 mi. N of Holt, Turkey Oak; 23 Oct. 1978; L. Stange leg.; human dung trap; DEBU • 1 ♂; Polk Co., Route 27, 7 mi. N of Route 14; 2–3 Nov. 1983; R.E. Woodruff leg.; pig dung trap; DEBU • 3 ♂♂, 1 ♀; Polk Co., 2 mi. N of Lake Wales; 25–29 Apr. 1983; R.E. Woodruff leg.; pig dung trap; DEBU • 4 ♂♂, 23 ♀♀; Putnam Co., Ocala National Forest, Johnson Field Campground; Apr. 1972; A. Newton leg.; mixed hardwood, dung trap; DEBU • 5 ♂♂, 3 ♀♀; Sarasota Co., Myakka River State Park; 21 May 1982; R.E. Woodruff leg.; pig dung trap; DEBU • 3 ♂♂, 3 ♀♀; Putnam Co., Myakka River State Park; 22–23 May 1982; R.E. Woodruff leg.; pig dung trap; DEBU • 3 ♂♂, 1 ♀; Volusia Co., Tomoka State Park; 20 Jun. 1984; S.A. Marshall leg.; dung trap; DEBU • 9 ♂♂, 13 ♀♀; same collection data as for preceding but mushroom trap; DEBU • 1 ♀; Hernando/Sumter Cos, Withlacoochee St. Forest, Croom Reserve; 12 Apr. 1989; K.N. Barber leg.; dung; DEBU • 2 ♂♂, 1 ♀; Hernando/Sumter Cos, Withlacoochee

St. Forest, Croom Reserve; 12 Apr. 1989; K.N. Barber leg.; dung vacuum; DEBU. – **Georgia** • 15 ♂♂, 20 ♀♀; Charlton Co., 14 mi. N of Folkston; 10–18 Apr. 1989; J.E. Swann leg.; pan trap, human dung; DEBU • 1 ♂, 1 ♀; Clinch Co., US 441, 8 mi. S of Fargo; 5–25 Jun. 1984; S.A. Marshall leg.; dung trap; DEBU • 2 ♂♂; Rabun Co., Chatahoochee State Forest, US 441 N of Turnerville; 5–25 Jun. 1984; S.A. Marshall leg.; mushroom trap; DEBU • 8 ♂♂, 20 ♀♀; Wilkinson Co., Big Sandy Creek, 4 mi. S of Irwinton; 5–25 Jun. 1984; S.A. Marshall leg.; dung trap; DEBU • 13 ♂♂, 10 ♀♀; same collection data as for preceding; FIT nr dung; DEBU. – **Louisiana** • 1 ♂, 1 ♀; East Baton Rouge Parish; 9 Apr. 1999; E.J. Watson leg.; swine carrion pitfall; DEBU • 3 ♂♂, 1 ♀; Grant Parish, Stuart Lake Campground, 18 km N of Alexandria; 19 May–17 Aug. 1983; S. and J. Peck leg.; forest, FIT; DEBU • 1 ♂, 2 ♀♀; “Jackson Co., LA, 1.5 mi. SE Paint Rock Nat. Cave”; 9 Jul. 1967; S. Peck leg.; rat dung, Berlese #77; DEBU. – **Missouri** • 1 ♀; Texas Co., 10.5 mi. NW of Licking, unnamed cave #1; 14 May 1980; J.E. Gardner leg.; DEBU. – **Mississippi** • 5 ♂♂, 8 ♀♀; Claiborne Co., Owen’s Creek, mi. 52, 19 km NE of Port Gibson; 18 May–16 Aug. 1983; S. and J. Peck leg.; forest, FIT; DEBU • 37 ♂♂, 35 ♀♀; Forrest Co., Sweet Bay Bog, 6 mi. W of Wiggins; 5–8 May 1994; S.A. Marshall leg.; sphagnum, dung trap; DEBU • 1 ♂; Scott Co., Forest; 5–9 May 1994; S.A. Marshall leg.; pans in prairie edge; DEBU. – **North Carolina** • 2 ♀♀; Jackson Co., Cullowhee, Cane Creek; 2300 ft a.s.l.; 5–25 Jun. 1984; S.A. Marshall leg.; riparian dung trap; DEBU • 1 ♂; Jackson Co., Cullowhee; 5–28 Jun. 1984; S.A. Marshall leg.; FIT; DEBU • 1 ♂, 5 ♀♀; Samson Co., Falcon at I95; 28 Sep.–4 Oct. 1983; R. Woodruff leg.; pig dung; DEBU. – **New Mexico** • 1 ♀; Eddy Co., 30 mi. WSW of Carlsbad, Sitting Bull Falls; 4600 ft a.s.l.; 23–27 Jul. 1975; S. Peck leg.; dung; DEBU. – **Oklahoma** • 1 ♂; Lattimer Co., 5 mi. W of Red Oak; 5–11 Jun. 1977; K. Stephan leg.; dung trap; DEBU. – **South Carolina** • 1 ♂, 1 ♀; Barnwell Co., Barnwell State Park; 10–18 Apr. 1989; T.A. Wheeler leg.; near lake, dung trap; DEBU • 6 ♂♂, 8 ♀♀; same collection data as for preceding; S.A. Marshall leg.; mushroom traps in oak forest; DEBU • 1 ♂, 3 ♀♀; Colleton Co., Colleton State Park; 27 Sep.–5 Oct. 1983; R.E. Woodruff leg.; pig dung trap; DEBU • 1 ♂, 4 ♀♀; Georgetown Co., Hobcaw Barony, Belle Baruch Marine Field Lab, Crabhaul Road near Picnic Road; 33°21’22” N, 79°12’45” W; 28–29 Apr. 2004; S.A. Marshall leg.; cypress swamp, yellow pans; DEBU • 11 ♂♂, 18 ♀♀; Georgetown Co., Hobcaw Barony, Belle Baruch Marine Field Lab, Crabhaul Road near Picnic Road; 33°21’22” N, 79°12’45” W; 29–30 Apr. 2004; Cheung and Macleod leg.; on dung; DEBU • 10 ♂♂, 18 ♀♀; same collection data as for preceding; NMNH • 1 ♂; Neeses Co., 13 mi. W of Orangeburg; 27 Mar. 1980; S.A. Marshall leg.; DEBU. – **Tennessee** • 1 ♂; Henderson Co., Natchez Trace State Park; 1000 ft a.s.l.; 18 Jun.–13 Jul. 1972; A. Newton leg.; dung; FMNH. – **Texas** • 3 ♀♀; Angelina Co., Angelina National Forest, Boykin Cemetery; 13–17 Jun. 1993; S.A. Marshall leg.; spring fen, dung; DEBU • 1 ♂, 6 ♀♀; Angelina Co., Angelina National Forest, Bouton Lake Campground; 12–14 Jun. 1993; S.A. Marshall leg.; dung/vac traps; DEBU • 1 ♂; Brazos Co., College Station, Lick Creek Park; 30°33’44” N, 96°12’53” W; 5–9 Apr. 2000; M. Buck leg.; bottomland forest near creek, Malaise trap; DEBU • 1 ♂; same collection data as for preceding; post oak savanna by creek, Malaise trap; DEBU • 1 ♀; Montgomery Co., 4.5 mi. N of Montgomery; 2 May–17 Jun. 1987; R.S. Anderson; pine/black walnut forest, FIT; DEBU • 4 ♂♂, 3 ♀♀; San Jacinto Co., Coldspring, Double Lake Campground; 22 May–16 Aug. 1983; S. and J. Peck leg.; FIT; DEBU • 3 ♀♀; San Jacinto Co., Double Lake Campground, 5 km S of Coldspring; 22–24 May 1983; S. Peck leg.; forest, carrion trap; DEBU • 4 ♂♂, 14 ♀♀; same collection data as for preceding but 22 May–16 Aug. 1983; S. and J. Peck leg.; forest, FIT; TAMU • 11 ♀♀; Tyler Co., Kirby State Forest, dung traps; 12–17 Jun. 1993; S.A. Marshall leg.; DEBU • 4 ♀♀; Tyler Co., Bouton Lake; 13–17 Jun. 1993; S.A. Marshall leg.; dung/vac traps; DEBU.

VENEZUELA – **Aragua** • 1 ♀; Henri Pittier National Park, Rancho Grande, La Toma; 1150 m a.s.l.; 9 Apr. 1994; L. Masner leg.; DEBU • 3 ♀♀; Maracay, Rancho Grande; 1200 m a.s.l.; 1–10 Aug. 1987; Bordon and Peck leg.; cloud forest, FIT; MIZA • 2 ♂♂, 4 ♀♀; 20 km NE of San Cristobal; 4000 ft a.s.l.; 18–22 May 1974; S. Peck leg.; dung trap; MIZA. – **Bolívar** • 3 ♂♂; km 40 on Santa Elena Icabaru Road; 1000 m a.s.l.; 4–6 Aug. 1986; B.D. Gill leg.; DEBU • 1 ♂; same collection data as for preceding; CNCI

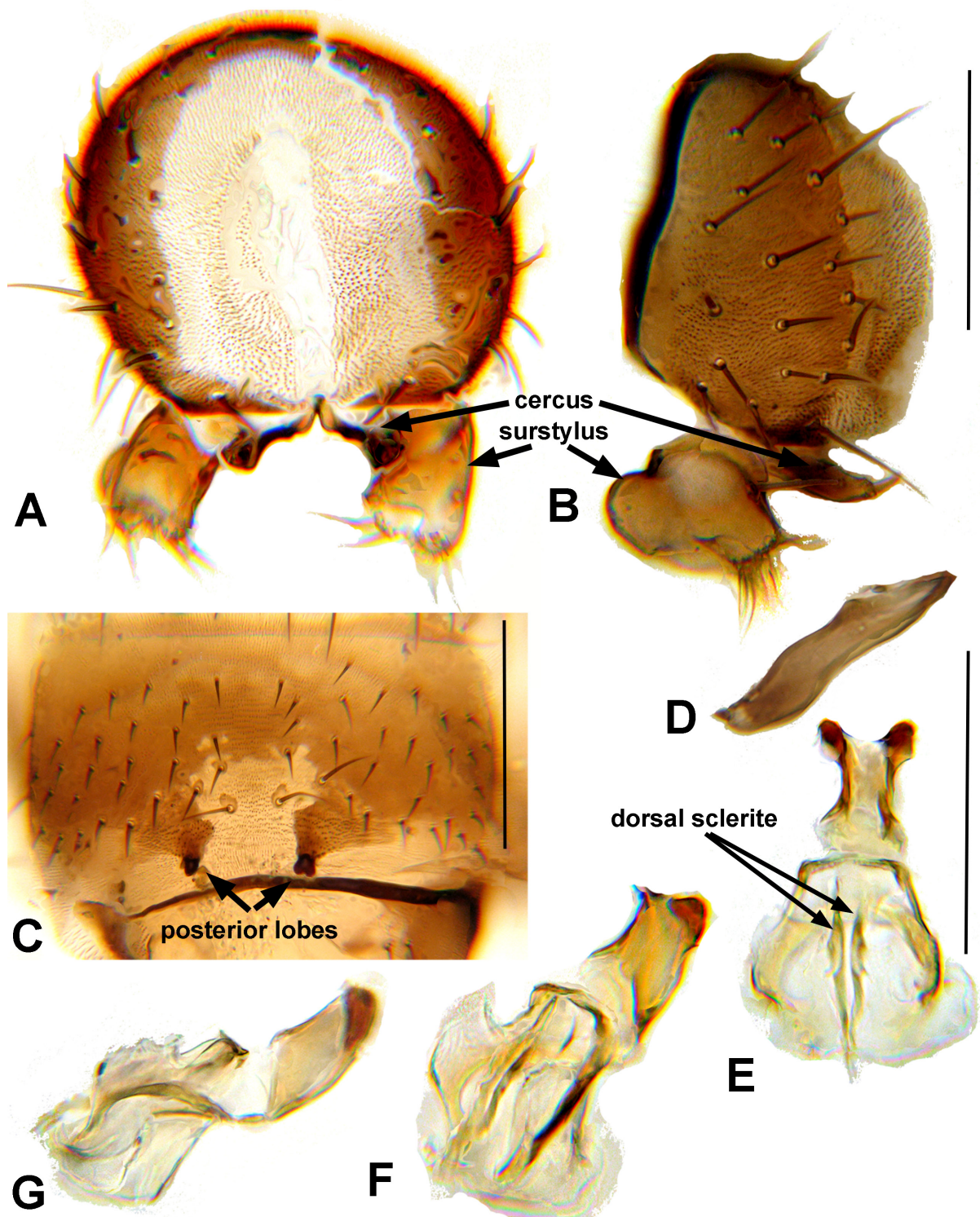

Fig. 9. *Rudolfina exuberata* sp. nov., male terminalia (debu00242299). **A.** Epandrium, surstylus and cercus, caudal view. **B.** Same as preceding, lateral view. **C.** Sternite 5, ventral view. **D.** Postgonite, close up lateral view. **E.** Phallus, dorsal view. **F.** Same as preceding, dorsolateral view. **G.** Same as preceding, lateral view. Scale bars: A–B = 0.10 mm; C = 0.10 mm; D–F = 0.10 mm.

• 3 ♀♀; 125 km S of El Dorado; 1100 m a.s.l.; 18 Jul.–7 Aug. 1986; B.D. Gill leg.; DEBU • 1 ♂, 2 ♀♀; 135 km S of El Dorado; 1400 m a.s.l.; 20 Jul.–7 Aug. 1986; B. Gill leg.; dung traps; CNCI • 1 ♂, 1 ♀; 10 km S of El Dorado; 200 m a.s.l.; 17 Jul.–7 Aug. 1986; B.D. Gill leg.; DEBU • 1 ♂; 33 km S of El Dorado; 220 m a.s.l.; 2–7 Aug. 1986; B.D. Gill leg.; CNCI • 1 ♀, km 40 on Santa Elena Icabaru Road; 220 m a.s.l.; 4–6 Aug. 1986; B.D. Gill leg.; MIZA • 1 ♀; 22 km S of El Dorado; 25 Jun.–12 Jul. 1987; S. and J. Peck leg.; lowland rainforest, FIT; DEBU.

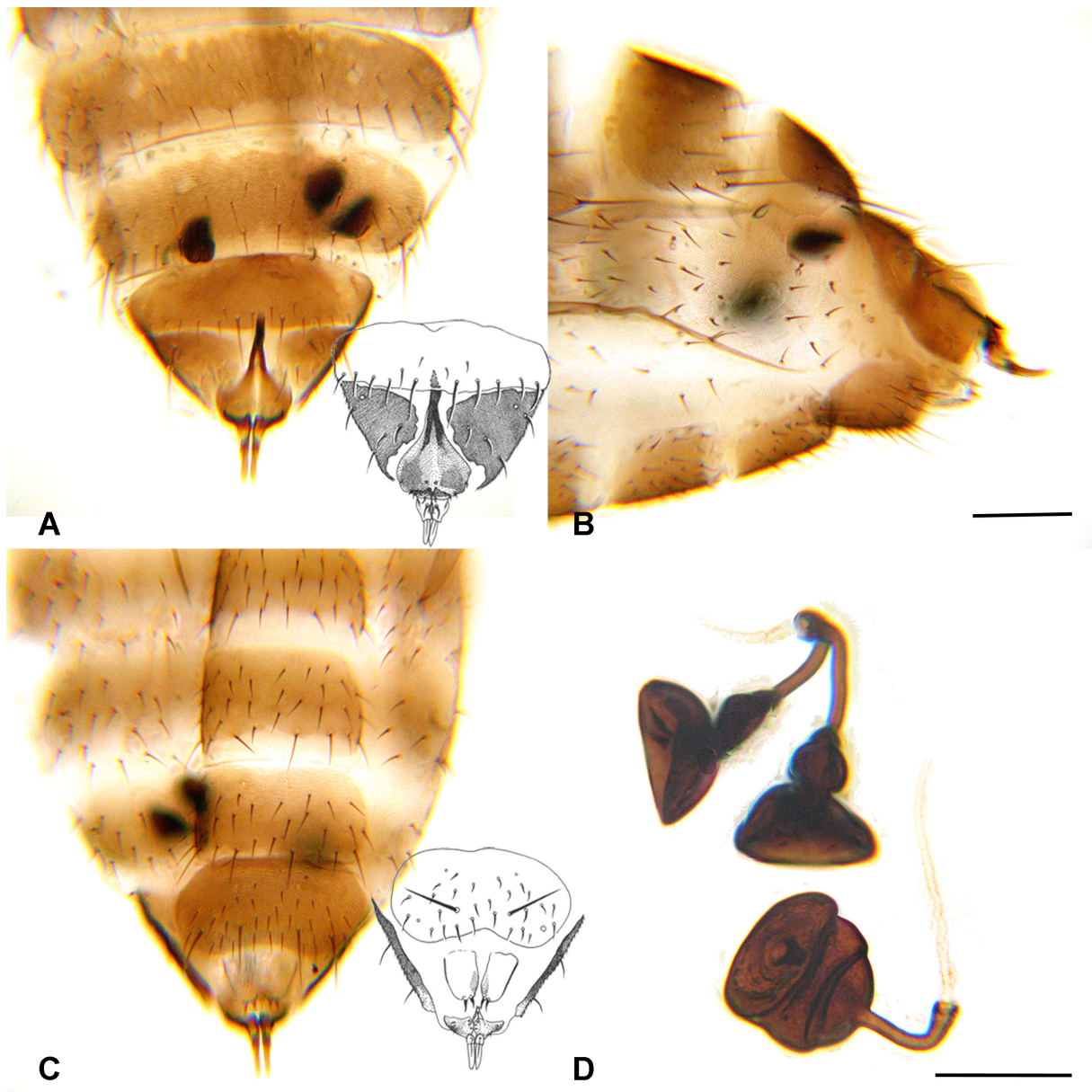

Fig. 10. *Rudolfina exuberata* sp. nov., female terminalia (A–C: debu00242299; D: debu00242286). A. Terminal abdominal segments, dorsal view. B. Same as preceding, lateral view. C. Same as preceding, ventral view. D. Spermathecae. Scale bars: A–C = 0.10 mm; D = 0.03 mm.

Description

BODY. Length 1.5–2.0 mm. Eye height $2.0\times$ genal height. Head with 4 interfrontal setae and row of 5–6 small setulae on inner margin of orbital plate. Gena with 1 strong seta and 5–7 smaller setulae. Acrostichal setulae in 6–8 rows. Costagial seta extending to humeral break. Second costal sector $0.3\text{--}0.4\times$ third costal sector. Length of M_1 between crossveins dm-cu and r-m $1.2\times$ dm-cu; CuA_1 stub vein $\sim 3.0\times$ M_1 stub vein. Male mid femur with single ventrobasal seta. Male mid tibia with as1 enlarged preapical seta and 1 smaller seta near midlength. Female mid tibia with midventral seta.

MALE ABDOMEN (Fig. 9). Sternite 5 with deep irregular posteromedial emargination flanked by blunt lobe on each side; emargination extending anteriorly $\frac{1}{3}$ length of sternite. Transverse part of sternite 6 straight. Surstylus (in lateral view) bilobed; anterior lobe rounded and bare; posterior lobe rounded but apically flattened and with 5–10 setae. Cercus projecting posteriorly, with apical seta. Postgonite simple, slightly sinuate, with small robust seta apically and 1–2 setulae along length. Dorsal sclerite of distiphallus (Fig. 9F–H) without distinct swellings.

FEMALE ABDOMEN (Fig. 10). Tergite 7 with posterior margin entire. Medial part of tergite 8 elongate, narrower anteriorly, posteriorly closely approximated with epiproct. Epiproct tulip-shaped, heavily sclerotized; longitudinally lightly sclerotized on apical half. Cercus strap-like, length $\sim 0.5\times$ epiproct. Sternite 7 wider than sternite 6; posterior margin with broad, shallow emargination. Spermathecae bilobed, constricted near midlength; distal portion cup-shaped, basal portion ovoid and narrowed before duct junction; spermatheca stem as long as spermathecal width.

Remarks

Rudolfina exuberata sp. nov. is the only species of *Rudolfina* that regularly occurs at low elevations and is widespread throughout South America, Central America and the southern United States.

Rudolfina exuberata sp. nov. resembles *R. pauca* sp. nov. in both sexes, but these species are distinguished by characters of the surstylus, male cercus and spermathecae.

Rudolfina howdeni sp. nov.

[urn:lsid:zoobank.org:act:0B9431DE-EFE1-41EC-B9B3-39303EDE435E](https://doi.org/10.3896/urn:lsid:zoobank.org:act:0B9431DE-EFE1-41EC-B9B3-39303EDE435E)

Figs 1A, 11–12, 21B

Etymology

This species name, which has been a manuscript name since Marshall (1982), is a patronym for Dr Henry Howden. Henry was a great entomologist and friend who advised SM during his M.Sc. at Carleton University; we regret that he did not live to see this beautiful species published.

Material examined

Holotype

MEXICO • ♂; Oaxaca, 6.6 mi. N of Ixtlan de Juarez; 8300 ft a.s.l.; 10–18 Aug. 1973; A. Newton leg.; oak woodland, human dung; FMNH debu01086096.

Paratypes

MEXICO – **Hidalgo** • 1 ♂; 7 mi. SW of Tenango de Doria; 7000 ft a.s.l.; 2–6 Jul. 1971; A. Newton leg.; cloud oak forest, human dung; DEBU. – **Jalisco** • 6 ♂♂, 1 ♀; 14 mi. W of Atenquique; 7900 ft a.s.l.; A. Newton leg.; hardwood forest, dung; CASC • 6 ♂♂; same collection data as for preceding; FMNH • 6 ♂♂; same collection data as for preceding; UNAM • 6 ♂♂; same collection data as for preceding; DEBU • 6 ♂♂, 4 ♀♀; 18 mi. W of Atenquique; 9300 ft a.s.l.; A. Newton leg.; fir forest, dung; CNCI •

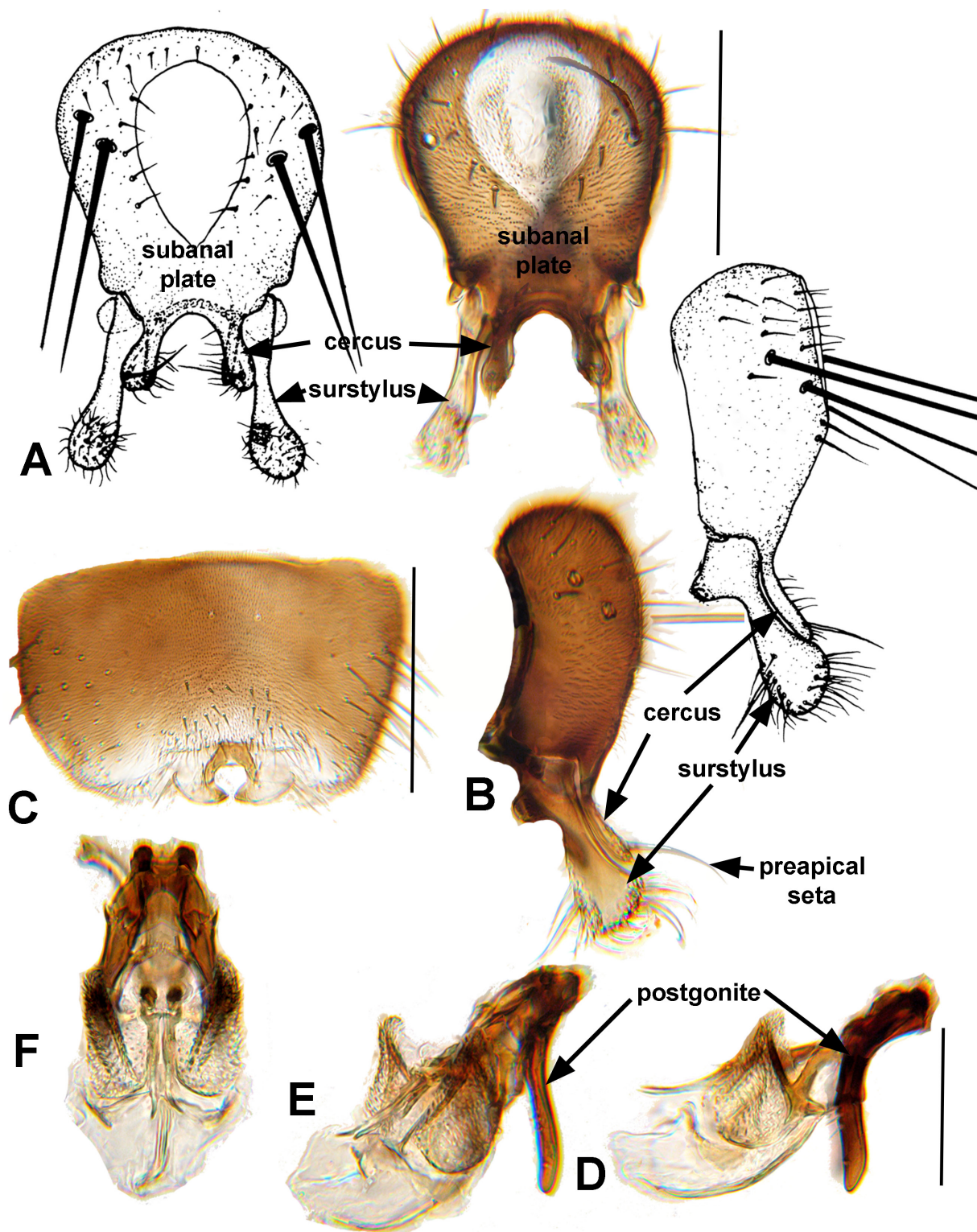

Fig. 11. *Rudolfina howdeni* sp. nov., male terminalia (debu01086163). **A.** Epandrium, surstylus and cercus, caudal view. **B.** Same as preceding, lateral view. **C.** Sternite 5, ventral view. **D.** Phallus and postgonites, lateral view. **E.** Same as preceding, dorsolateral view. **F.** Same as preceding, dorsal view. Scale bars: A–B = 0.10 mm; C = 0.10 mm; D–F = 0.05 mm.

7 ♂♂, 3 ♀♀; same collection data as for preceding; FMNH • 5 ♂♂, 3 ♀♀; same collection data as for preceding; UNAM. – **México** • 3 ♂♂; 1 mi. E of Ixtapan de la Sal, at km 78; 6200 ft a.s.l.; 31 Aug.–6 Sep. 1971; A. Newton leg.; Trop/Dec/Jan., human dung; DEBU • 5 ♂♂, 1 ♀; 5 mi. E of Santa Marta, at km 8.5; 10 100 ft a.s.l.; 29 Aug.–4 Sep. 1971; A. Newton leg.; fir forest, human dung; DEBU. – **Morelos** • 2 ♀♀; 4 mi. W of Tres Cumbres, at km 6; 8900 ft a.s.l.; 29 Aug.–4 Sep. 1971; A. Newton leg.; oak, human dung; DEBU • 6 ♂♂, 4 ♀♀; 4 mi. W of Tres Cumbres, at km 6¾; 9000 ft a.s.l.; 29 Aug.–4 Sep. 1971; A. Newton leg.; oak, human dung; DEBU. – **Oaxaca** • 2 ♂♂, 2 ♀♀; same collection data as for holotype; DEBU • 2 ♂♂, 2 ♀♀; same collection data as for holotype; FMNH • 1 ♂; 29.7 mi. S of Valle Nacional; 6800 ft a.s.l.; 11–17 Aug. 1973; A. Newton leg.; cloud forest, dung; DEBU • 1 ♂; 2.0 mi. W of Jct. Mex. 175-Yuvila Rd; 9500 ft a.s.l.; 8–19 Aug. 1973; A. Newton leg.; oak-pine, dung;

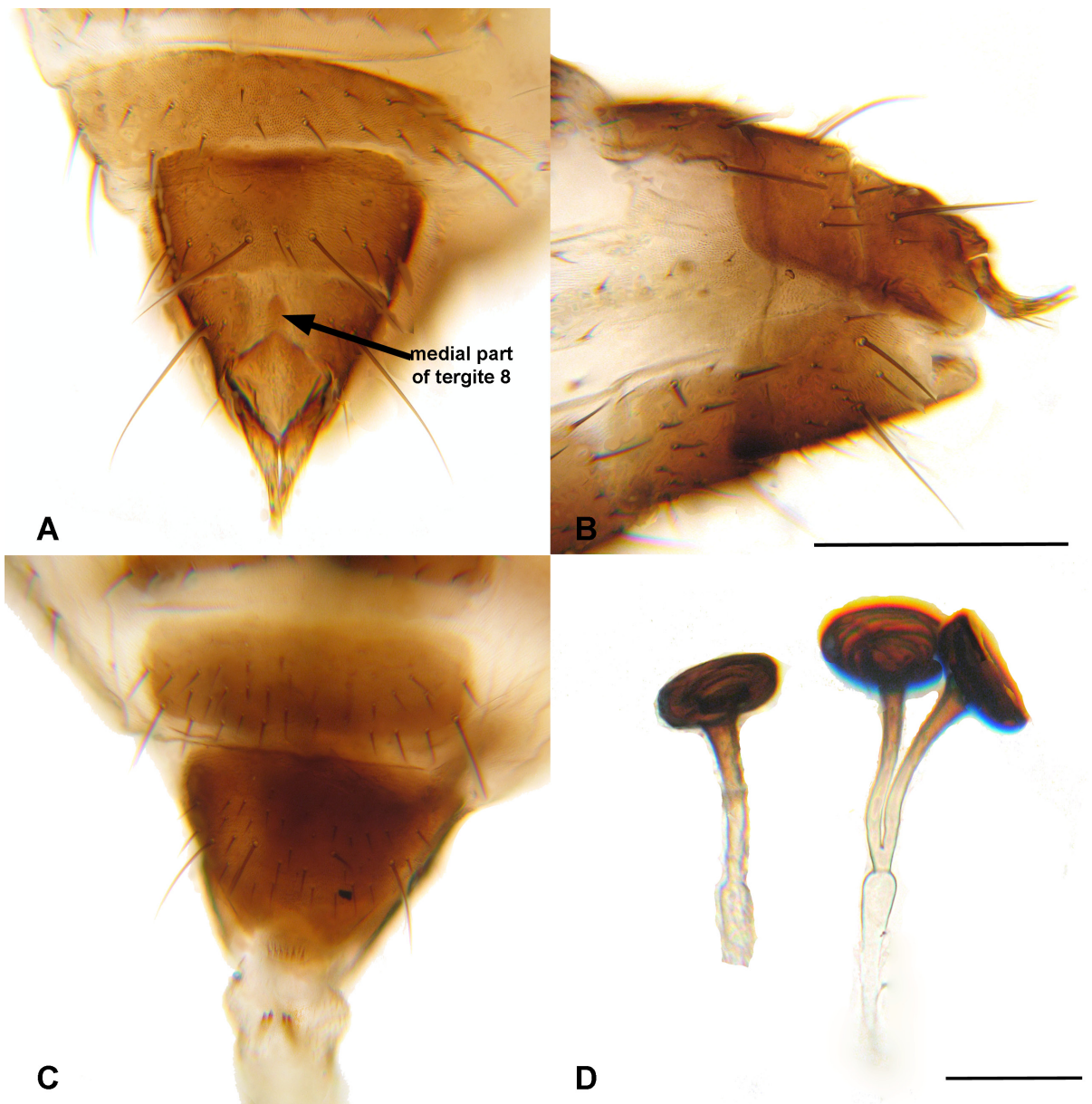

Fig. 12. *Rudolfina howdeni* sp. nov., female terminalia (debu1086100). **A.** Terminal abdominal segments, dorsal view. **B.** Same as preceding, lateral view. **C.** Same as preceding, ventral view. **D.** Spermathecae. Scale bars: A–C = 0.30 mm; D = 0.04 mm.

DEBU • 1 ♂; 4.1 mi. W of Jct. Mex. 175-Yuvila Rd; 9300 ft a.s.l.; 8–19 Aug. 1973; A. Newton leg.; oak-fir-pine forest; DEBU • 1 ♂; 5 mi. E of Jct. Mex. 175-Yuvila Rd; 7600 ft a.s.l.; 9–19 Aug. 1973; A. Newton leg.; oak, pine, dung; DEBU • 1 ♂; 20 mi. N of Ixtlan; 2835 m a.s.l.; 24–27 Jul. 1971; A. Newton leg.; oak-pine; DEBU. – **Veracruz** • 1 ♂; Ciudad Mendoza, 8.2 mi. W on Mex. 150D; 6200 ft a.s.l.; 27 Jul.–3 Aug. 1973; A. Newton leg.; oak woodland, carrion; DEBU.

Description

BODY. Length: 1.6–2.0 mm. Eye height $2.0 \times$ genal height. Head with 4–5 interfrontal setae and row of 6–8 small setulae on inner margin of orbital plate. Gena with 2 setae and 6–8 setulae. Acrostichal setulae in 4–6 rows. Costa with costagial seta extending to subcostal break. Second costal sector $\sim 0.85 \times$ third costal sector. Length of M_1 between crossveins dm-cu and r-m $\sim 2.0 \times$ dm-cu; CuA_1 stub vein $\sim 7.0 \times$ M_1 stub vein. Male mid femur with 10–15 setae in ovoid ventrobasal cluster. Male mid tibia with ventral comb of 6–7 robust, short setae on apical $\frac{1}{2}$.

MALE ABDOMEN (Fig. 11). Posterior margin of sternite 5 with pair of large medially-projecting blunt teeth on each side of emargination; emargination extending $\sim \frac{1}{4}$ length and $\sim \frac{1}{8}$ width of sternite 5; emargination lined with sclerotized strip. Transverse part of sternite 6 weakly arcuate. Epandrium with pair of long lateral setae, 3–4 smaller pairs of setae along lower margin of anal opening and several other small setae scattered over the surface; subanal plate narrow but complete. Surstylus (in lateral view) with small hirsute anterior lobe and elongate clavate posterior lobe ($\sim 4.0 \times$ length of anterior lobe); posterior lobe with 4–5 large setae and numerous smaller setae apically, and 2–3 bifurcating setae on inner surface. Cercus elongate, clavate, projecting ventrally. Postgonite elongate, narrowly rounded apically. Dorsal sclerite of distiphallus (Fig. 11F–H) not swollen along length and not extending beyond apex of acrophallus.

FEMALE ABDOMEN (Fig. 12). Posterior margin of tergite 7 entire or slightly emarginate medially. Medial part of tergite 8 elongate (length ~ 1.5 – $3.0 \times$ width), with anterior margin rounded (some specimens with posterior half poorly sclerotized and difficult to see). Epiproct diamond-shaped. Cercus as long as epiproct, with elongate preapical seta. Sternite 7 entire. Spermathecae cup-shaped and short, with sclerotized duct $\sim 3.5 \times$ length of spermatheca.

Remarks

The male sternite 5, epandrium, surstylus and cercus are unique within *Rudolfina*.

Rudolfina megepandria sp. nov.

[urn:lsid:zoobank.org:act:16E7249F-BC7E-4CD0-AFCB-60A5C98CFB43](https://zoobank.org/act:16E7249F-BC7E-4CD0-AFCB-60A5C98CFB43)

Figs 4, 13, 21B

Etymology

The specific name, which has been a manuscript name since Marshall (1982), refers to the unusually large epandrium.

Material examined

Holotype

MEXICO • ♂; Jalisco, 18 mi. W of Atenquique; 9300 ft a.s.l.; A. Newton leg.; fir forest, dung; FMNH debu01086084.

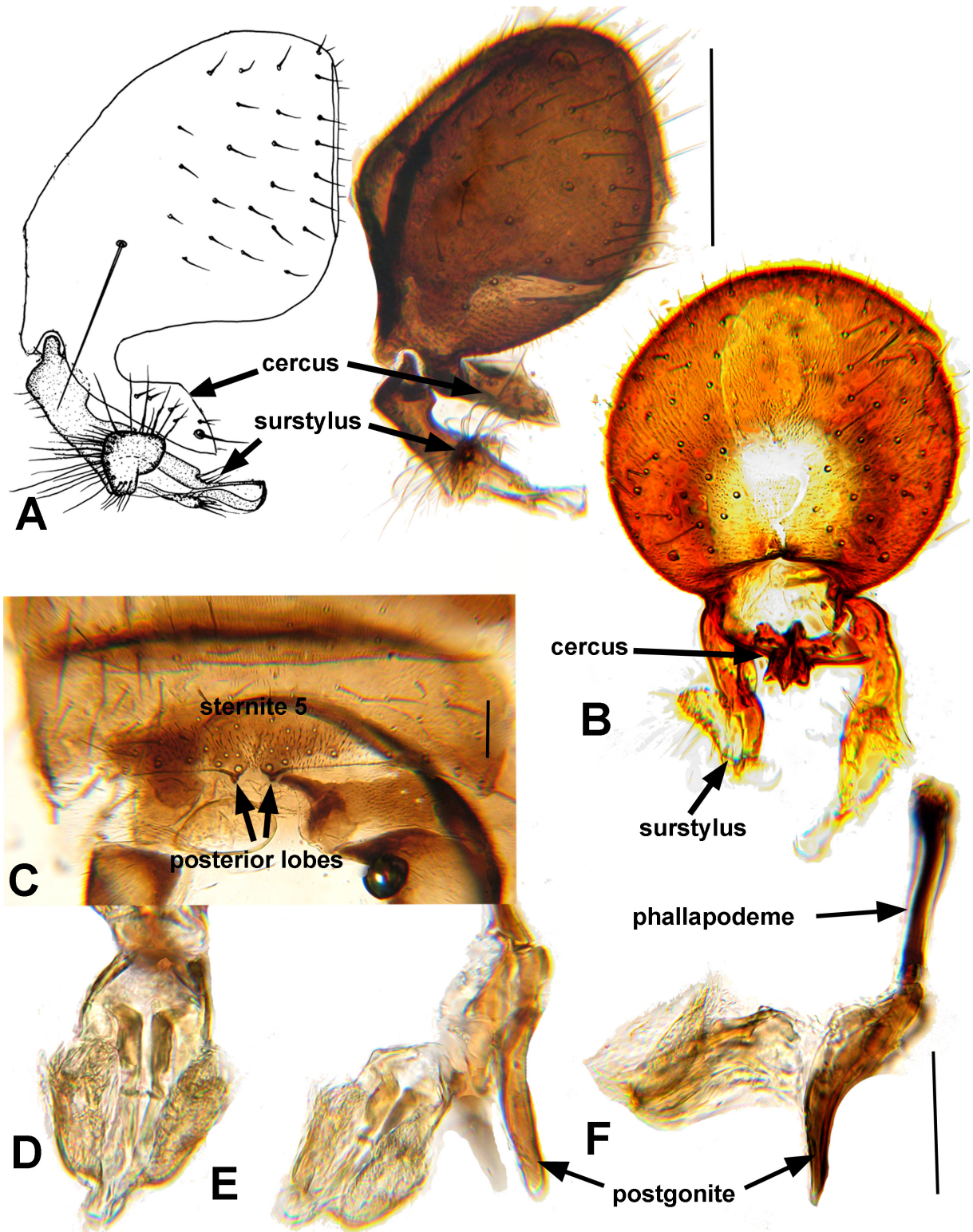

Fig. 13. *Rudolfina megepandria* sp. nov., male terminalia (debu01086085). **A.** Epandrium, surstylus and cercus, lateral view. **B.** Same as preceding, caudal view. **C.** Sternites 4–7, ventral view. **D.** Phallus and postgonite, dorsal view. **E.** Phallus, postgonite and phallapodeme, dorsolateral view. **F.** Same as preceding, lateral view. Scale bars: A–B = 0.20 mm; C = 0.05 mm; D–F = 0.05 mm.

Paratypes

MEXICO – **Jalisco** • 1 ♂, 1 ♀; same collection data as for holotype; DEBU. – **Oaxaca** • 1 ♀; Yuvila Rd; 9400 ft a.s.l.; 9–19 Aug. 1973; A. Newton leg.; mesic oak, carrion; FMNH.

Description

BODY. Length: 1.9–2.2 mm. Eye height $2.5 \times$ genal height. Head with 3 interfrontal setae and row of 4–5 small setulae on inner margin of orbital plate. Gena with 2 strong setae and 7–8 smaller setulae. Acrostichal setulae in 4–6 rows. Costagial seta extending to subcostal break. Second costal sector $0.75\text{--}0.8 \times$ third costal sector. Length of M_1 between crossveins dm-cu and r-m $3.0 \times$ dm-cu; CuA_1 stub vein $\sim 10.0 \times$ M_1 stub vein (M_1 stub vein extremely reduced). Male mid femur with 14–15 strong setae in ventrobasal cluster. Male mid tibia with ventral comb of 4–5 robust, short setae on apical $\frac{1}{2}$. Mid tibia without midventral seta (both sexes).

MALE ABDOMEN (Fig. 13). Sternite 5 posterior margin with 2 small nipple-like teeth on each side of small emargination; emargination $\sim \frac{1}{15}$ width and $\sim \frac{1}{9}$ length of sternite 5. Transverse part of sternite 6 arcuate. Epandrium swollen, broader than preceding abdominal segments; subanal plate broad, complete. Surstylus with posterior lobe elongate, length $\sim 4.0 \times$ basal width, with a hirsute medial lateral lobe; apex truncate. Cercus elongate-conical, projecting posteriorly. Postgonite elongate, narrowly rounded distally and narrow basally. Dorsal sclerite of distiphallus (Fig. 13D–F) without dorsal swellings and not extending beyond apex of acrophallus.

FEMALE ABDOMEN (Fig. 4). Tergite 7 with posterior margin entire. Medial part of tergite 8 elongate, length $\sim 2.0\text{--}3.0 \times$ width, with posterior margin emarginate. Epiproct broadly rounded anteriorly. Cercus $\sim 0.75 \times$ length of epiproct; fused anterolaterally to epiproct. Sternite 7 with posterior margin broadly rounded. Spermathecae cup-shaped; paired spermathecae with stems $\sim 1.5 \times$ width of spermatheca.

Remarks

Rudolfina megepandria sp. nov. is diagnosed by its swollen male epandrium and distinctively shaped sternite 5. It is most closely related to *R. bucki* sp. nov., which has a less pronounced epandrium and differs in details of the surstylus and cercus.

Rudolfina newtoni sp. nov.

[urn:lsid:zoobank.org:act:02FE2BAE-7EEF-4889-A3DD-9540B9DE96C1](https://doi.org/10.21203/rs.3.rs-1086218/v1)

Figs 14–15, 21C

Etymology

The species name is a patronym for Dr Alfred Newton, the collector of all known specimens of this species.

Material examined

Holotype

MEXICO • ♂; Oaxaca, 4.1 mi. W of Jct. Mex. 175-Yuvila Rd; 9300 ft a.s.l.; 8–19 Aug. 1973; A. Newton leg.; oak-fir-pine forest; FMNH debu01086218.

Paratypes

MEXICO – **Oaxaca** • 6 ♂♂, 4 ♀♀; same collection data as for holotype; DEBU • 5 ♂♂, 4 ♀♀; same collection data as for holotype; FMNH • 1 ♂, 1 ♀; 25 mi. N of Ixtlan; $17^{\circ}33'0''$ N, $96^{\circ}31'12''$ W; 9100 ft a.s.l.; 23–29 Jul. 1971; A. Newton leg.; oak-pine, human dung; FMNH • 3 ♂♂, 1 ♀; 20 mi. N of Ixtlan; 2835 m a.s.l.; 24–27 Jul. 1971; A. Newton leg.; oak-pine; DEBU • 1 ♀; 28 mi. N of Ixtlan; 9500 ft

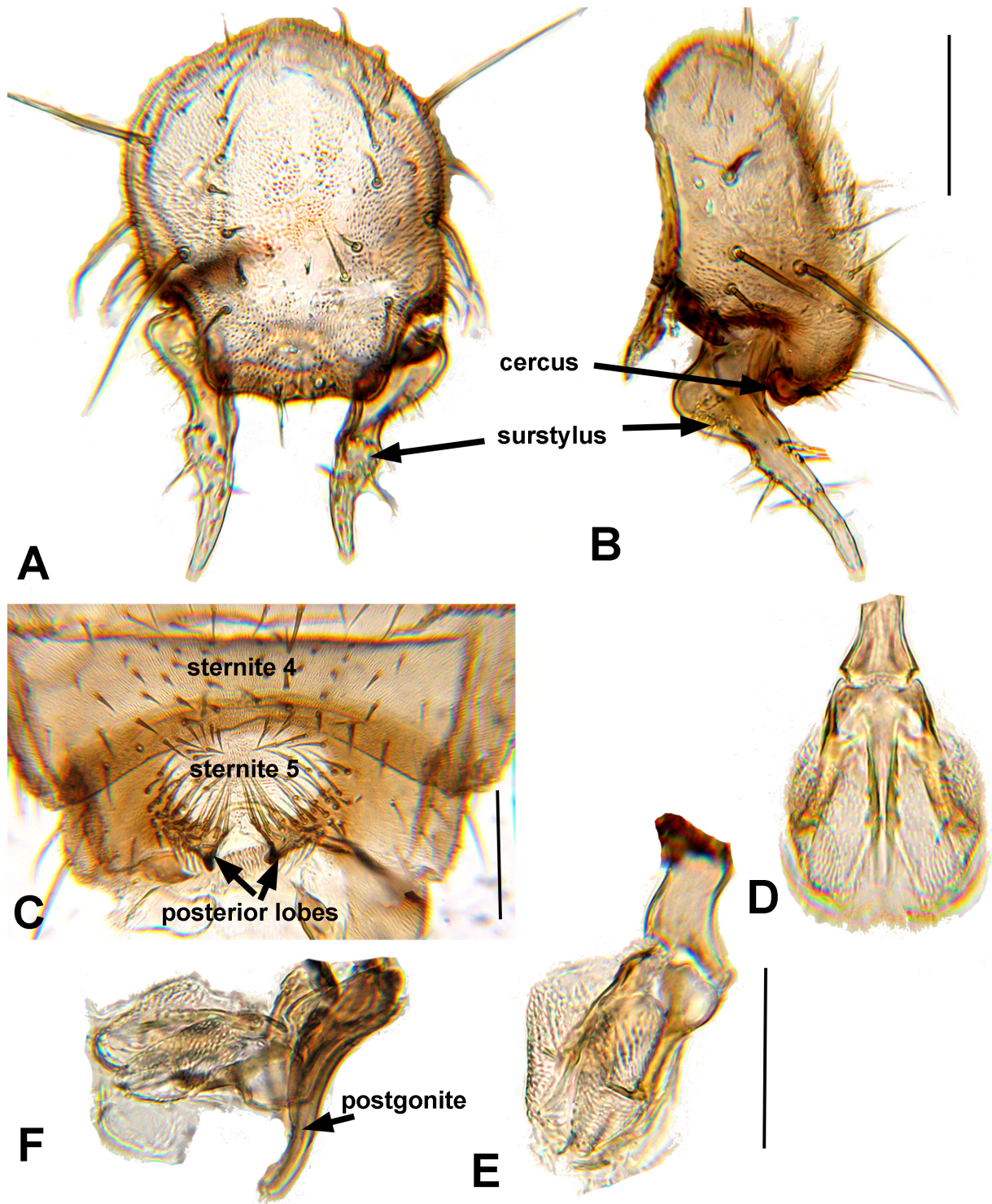

Fig. 14. *Rudolfina newtoni* sp. nov., male terminalia (A–E: debu01086234; F: debu01086234). A. Epandrium, surstylus and cercus, caudal view. B. Same as preceding, lateral view. C. Sternites 4 and 5, ventral view. D. Phallus, dorsal view. E. Phallus, dorsolateral view. F. Phallus and postgonite, lateral view. Scale bars: A–B = 0.10 mm; C = 0.10 mm; D–F = 0.05 mm.

a.s.l.; 23–29 Jul. 1971; A. Newton leg.; pine-heath, human dung; DEBU • 4 ♂♂, 4 ♀♀; 2.0 mi. W of Jct. Mex. 175-Yuvila Rd; 9500 ft a.s.l.; 8–19 Aug. 1973; A. Newton leg.; oak-pine, dung; DEBU • 4 ♂♂, 5 ♀♀; same collection data as for preceding; UNAM • 2 ♀♀; 1.7 mi. W of Jct. Mex. 175-Yuvila Rd; 2865 m a.s.l.; 9–19 Aug. 1973; A. Newton leg.; mesic oak, fish trap; DEBU • 7 ♂♂, 6 ♀♀; 1.4 mi. W of Jct. Mex. 175-Yuvila Rd; 9300 ft a.s.l.; 9–19 Aug. 1973; A. Newton leg.; mesic oak forest; DEBU • 3 ♂♂, 2 ♀♀; same collection data as for preceding; dung; DEBU.

Description

BODY. Length: 1.6–2.0 mm. Eye height $1.5 \times$ genal height. Head with 4 interfrontal setae and row of 6–7 small setulae on inner margin of orbital plate. Gena with 2 strong setae and 6–8 smaller setulae.

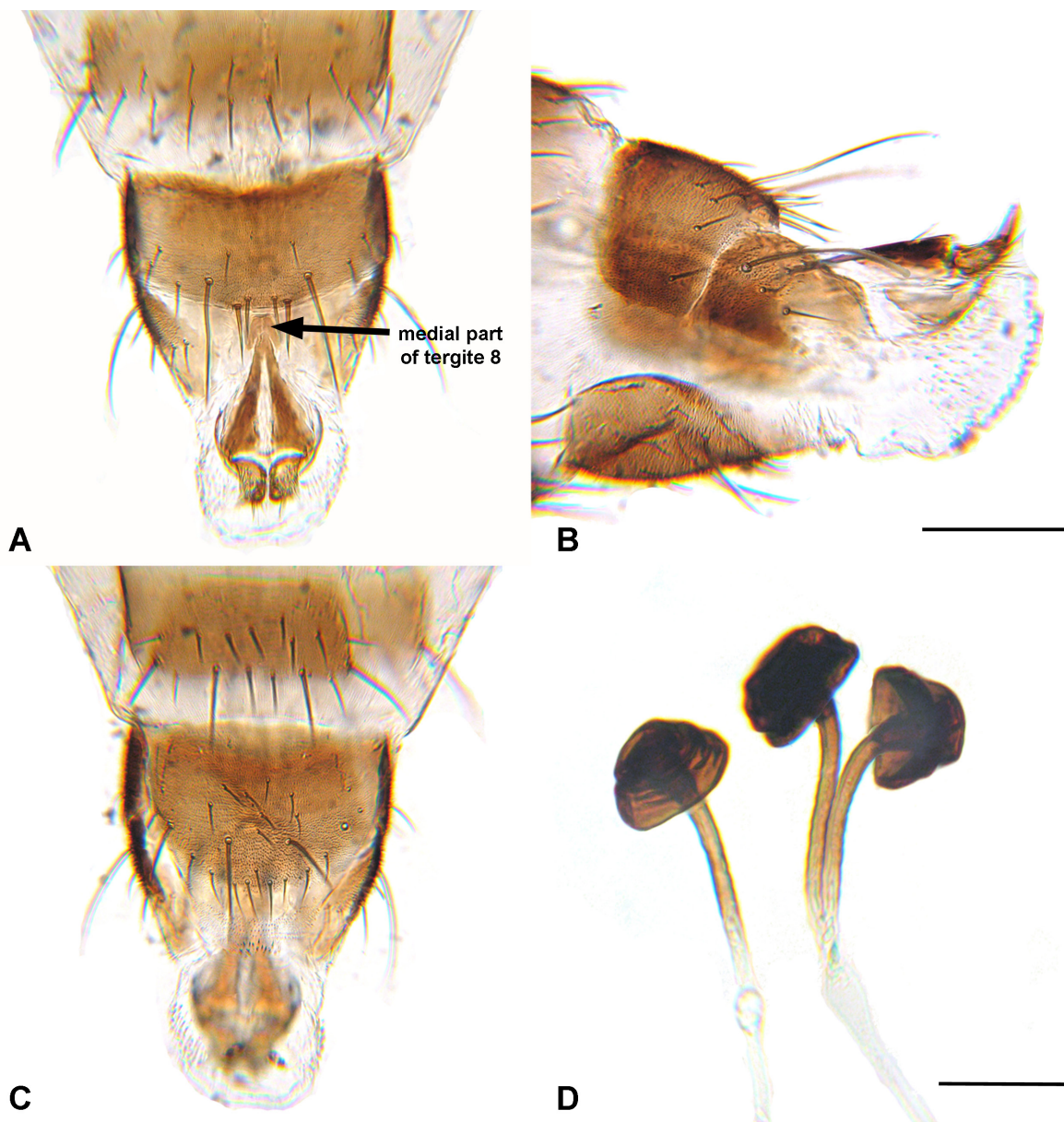

Fig. 15. *Rudolfina newtoni* sp. nov., female terminalia (debu01086226). **A.** Terminal abdominal segments, dorsal view. **B.** Same as preceding, lateral view. **C.** Same as preceding, ventral view. **D.** Spermathecae. Scale bars: A–C = 0.10 mm; D = 0.04 mm.

Acrostichal setulae in 6–8 rows. Costagial seta extending slightly beyond humeral break. Second costal sector $\sim 1.2 \times$ as long as third. Length of M_1 between crossveins dm-cu and r-m $2.0 \times$ dm-cu; CuA_1 stub vein $\sim 4.0 \times$ M_1 stub vein. Male mid femur with 20–21 strong setae in ventrobasal cluster. Male mid tibia with ventral comb of 8 robust setae on apical $\frac{1}{2}$.

MALE ABDOMEN (Fig. 14). Sternite 5 posterior margin with two distinct teeth on each side of large emargination; emargination forming a broad circular desclerotized area, $\sim \frac{1}{3}$ width of sclerite and extending anteriorly $\sim \frac{3}{4}$ of length; margin of emargination with numerous setae on posterior $\frac{2}{3}$. Transverse part of sternite 6 arcuate. Epanthrium with pair of long mediolateral setae, with 2–3 smaller pairs lateral to large pair; subanal plate narrowly continuous below anal opening. Surstylus (in lateral view) with anterior lobe reduced to small basal swelling; posterior lobe elongate, length $\sim 4.0 \times$ basal width, tapering to narrowly rounded apex; bent posteriorly near basal $\frac{1}{4}$, with 4–5 setae on both ventral and dorsal surfaces. Cerci quadrate, weakly differentiated from each other and from epanthrium, with pair of ventromedial setae. Postgonite narrow, slightly sinuate, with 4 small dorsal setulae on apical $\frac{1}{2}$. Dorsal sclerite of distiphallus (Fig. 14D–F) without swellings and not extending beyond apex of acrophallus.

FEMALE ABDOMEN (Fig. 15). Posterior margin of tergite 7 entire. Medial part of tergite 8 short and kidney-shaped, with posterior margin emarginate. Epiproct triangular, elongate, with mid-line desclerotized. Cercus half as long as epiproct, with flattened apical seta; narrowly fused anterolaterally to epiproct. Posterior margin of sternite 7 entire or slightly arcuate. Spermathecae inverted cup-shaped (with duct, appearing mushroom-shaped) and wrinkled; sclerotized portion of ducts $\sim 2.0 \times$ length of spermatheca; common duct of paired spermathecae poorly sclerotized.

Remarks

This species is distinguished from other *Rudolfina* by characters of the surstylus and male sternite 5. The female epiproct is intermediate in shape between the strongly modified epiproct found in the *R. exuberata* group and the unmodified epiproct of other *Rudolfina*.

Rudolfina pauca sp. nov.

[urn:lsid:zoobank.org:act:F085E96F-6CCB-49B0-83B8-503F18F1B472](https://doi.org/10.3896/urn:lsid:zoobank.org:act:F085E96F-6CCB-49B0-83B8-503F18F1B472)

Figs 16–17, 21C

Etymology

The species name is the Latin for ‘few’. Compared to the closely related *R. exuberata* sp. nov., which occurs throughout the Neotropical region and has been collected at over a hundred different sites, *R. pauca* sp. nov. has been infrequently collected and remains known from only five sites in Mexico and Guatemala.

Material examined

Holotype

MEXICO • ♂; México, 1 mi. NE of Tenancingo; 7100 ft a.s.l.; 31 Aug.–6 Sep. 1971; A. Newton leg.; oak-pine-madrone, human dung; FMNH debu01086244.

Paratypes

GUATEMALA – **San Marcos** • 1 ♀; San Antonio Sacatepéquez; 14°58' N, 91°44' W; 8000 ft a.s.l.; 29 Sep. 1986; M.J. Sharkey leg.; DEBU.

MEXICO – **Hidalgo** • 1 ♂, 1 ♀; 4 mi. W of Tulancingo; 7600 ft a.s.l.; 1–6 Jul. 1971; A. Newton leg.; human dung; DEBU. – **México** • 6 ♂♂, 10 ♂♂; same collection data as for holotype; FMNH • 8 ♂♂,

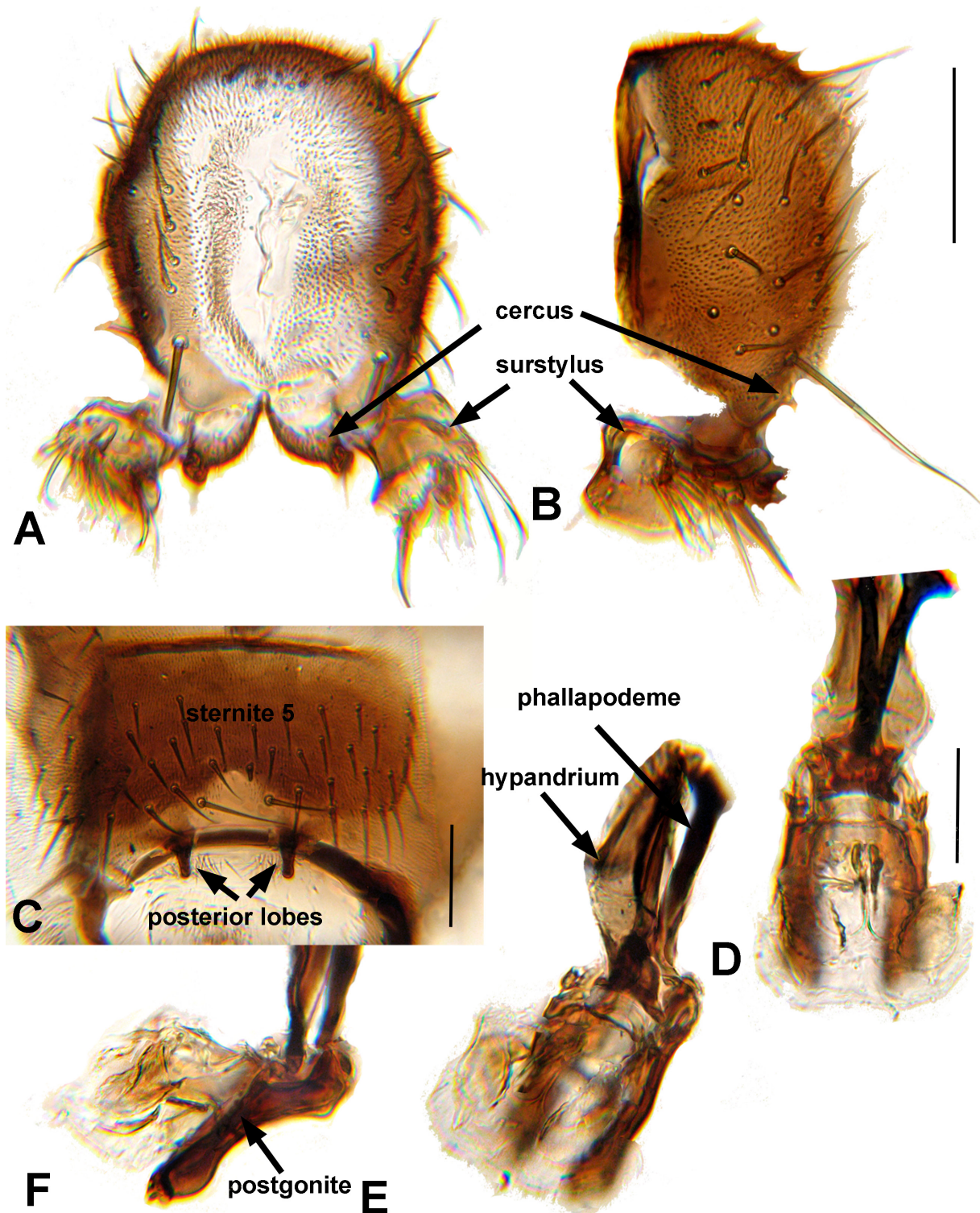

Fig. 16. *Rudolfina pauca* sp. nov., male terminalia (debu1086247). **A.** Epandrium, surstylus and cercus, caudal view. **B.** Same as preceding, lateral view. **C.** Sternite 5, ventral view. **D.** Phallus, postgonites and phallapodeme, dorsal view. **E.** Phallus, postgonites, hyandrium and phallapodeme, dorsolateral view. **F.** Same as preceding, lateral view. Scale bars: A–B = 0.10 mm; C = 0.10 mm; D–F = 0.05 mm.

10 ♂♂; same collection data as for holotype; DEBU • 2 ♀♀; 3 mi. SW of Tenancingo, at km 52¼; 7100 ft a.s.l.; 31 Aug.–6 Sep. 1971; A. Newton leg.; oak-juniper, human dung; DEBU • 2 ♂♂, 1 ♀; same collection data as for preceding; UNAM. – **Morelos** • 1 ♀; 8 mi. S of Tres Cumbres; 7400 ft a.s.l.; 29 Aug.–4 Sep. 1971; A. Newton leg.; oak/pine forest, dung; DEBU.

Description

BODY. Length: 1.4–1.9 mm. Eye height $1.3 \times$ genal height. Head with 4 interfrontal setae and row of 8–10 small setulae on inner margin of orbital plate. Gena with 1 strong seta and 8 smaller setulae. Acrostichal setulae in 6–8 rows. Costagial seta extending to humeral break; second costal sector shorter than third (20:35); length of M_1 between crossveins dm-cu and r-m $1.2 \times$ dm-cu; CuA_1 stub vein $\sim 2.0 \times$

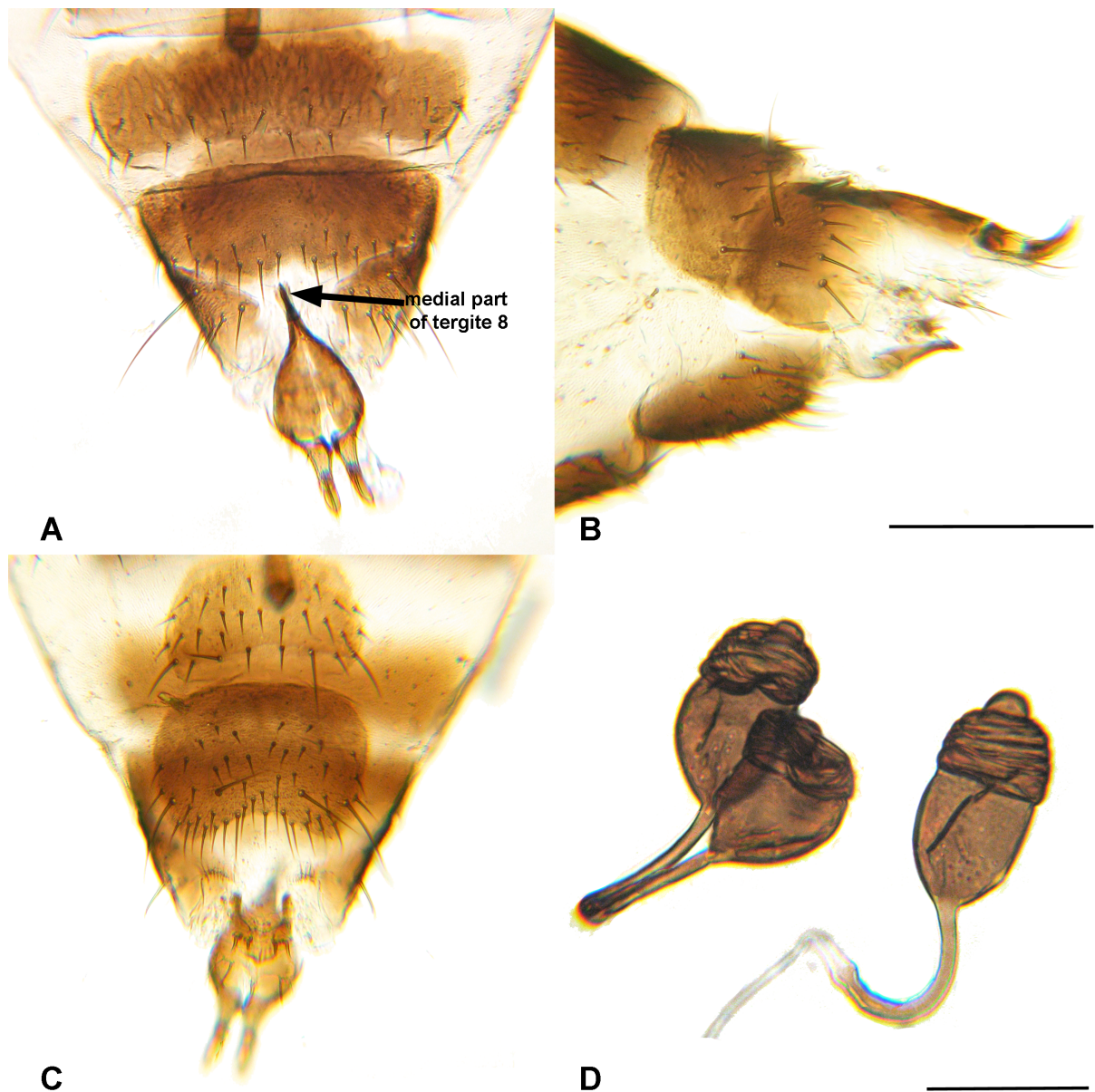

Fig. 17. *Rudolfina pauca* sp. nov., female terminalia (debu01086258). **A.** Terminal abdominal segments, dorsal view. **B.** Same as preceding, lateral view. **C.** Same as preceding, ventral view. **D.** Spermathecae. Scale bars: A–C = 0.20 mm; D = 0.05 mm.

M₁ stub vein. Male mid femur with 4–5 weak setae in ventrobasal cluster. Male mid tibia with ventral comb of 11–13 robust setae on apical ½.

MALE ABDOMEN (Fig. 16). Sternites 3–4 evenly haired. Posterior margin of sternite 5 with lobes elongate, projecting posteriorly; emargination extending anteriorly ~¼ length of sternite, ~¼ width of sternite at posterior margin. Transverse part of sternite 6 weakly arcuate. Epanthrium with 2 long ventrolateral setae and scattered setulae; subanal plate narrowly continuous below anal opening. Surstylus (in lateral view) trilobed, with anterior lobe rounded and bare, middle lobe small, rounded and with 4–6 distal setae apically, and posterior lobe posteriorly projecting and rounded, with 1 large, flattened seta and 2–3 regular setae apically. Cercus small and conical, projecting posterolaterally, with 2 apical setae. Postgonite slightly capitate or oar-shaped, with apex ventrally emarginate; 3–4 setulae present along dorsal surface. Dorsal sclerite of distiphallus (Fig. 16D–F) without swellings and not extending beyond apex of acrophallus.

FEMALE ABDOMEN (Fig. 17). Posterior margin of tergite 7 medially emarginate. Medial part of tergite 8 elongate, rectangular (length ~3.0 × width) and poorly sclerotized; overlapping basal projection of epiproct. Epiproct tulip-shaped, with elongate narrow anterior extension. Cercus reduced, shorter than apical flattened seta; fused anterolaterally to epiproct. Spermathecae acorn-shaped, with a small, smooth distal bulb, a wrinkled medial section and a smooth basal section; paired spermathecae with stems as long as spermatheca; common duct of pair short, ~⅓ length of stems.

Remarks

See comments under *R. exuberata* sp. nov.

Rudolfina pilosa sp. nov.

[urn:lsid:zoobank.org:act:8E664032-9FD5-4ED0-9A39-B63395A39655](https://zoobank.org/act:8E664032-9FD5-4ED0-9A39-B63395A39655)

Figs 18, 21C

Etymology

The species epithet is from the Latin for ‘hairy’, referring to the hirsute sternites 4 and 5 of the male.

Material examined

Holotype

MEXICO • ♂; Oaxaca, 2.0 mi. W of Jct. Mex. 175-Yuvila Rd; 9500 ft a.s.l.; 8–19 Aug. 1973; A. Newton leg.; oak-pine, dung; FMNH debu01086240.

Paratypes

MEXICO – Oaxaca • 1 ♂; 6.6 mi. N of Ixtlan de Juarez; 8300 ft a.s.l.; 10–18 Aug. 1973; A. Newton leg.; oak woodland, human dung; DEBU • 1 ♂; 4.1 mi. W of Jct. Mex. 175-Yuvila Rd; 9300 ft a.s.l.; 8–19 Aug. 1973; A. Newton leg.; oak-fir-pine forest; UNAM • 1 ♂; same collection data as for preceding; oak-fir-pine forest; FMNH.

Description

BODY. Length: 1.5–1.8 mm. Eye height 2.5 × genal height. Head with 3 interfrontal setae and 5–6 small setae along inner margin of orbital plate. Gena with 2 strong setae and 7–9 smaller setulae. Acrostichal setulae in 4–6 rows. Costagial seta extending slightly beyond humeral break; second costal sector equal to third sector; length of M₁ between crossveins dm-cu and r-m 2.0 × dm-cu; CuA₁ stub vein ~5.0 × M₁ stub vein. Male mid femur with 4–5 small setae in ventrobasal cluster. Male mid tibia with ventral comb of 7–8 robust setae on apical ½, midventral seta absent (female unknown).

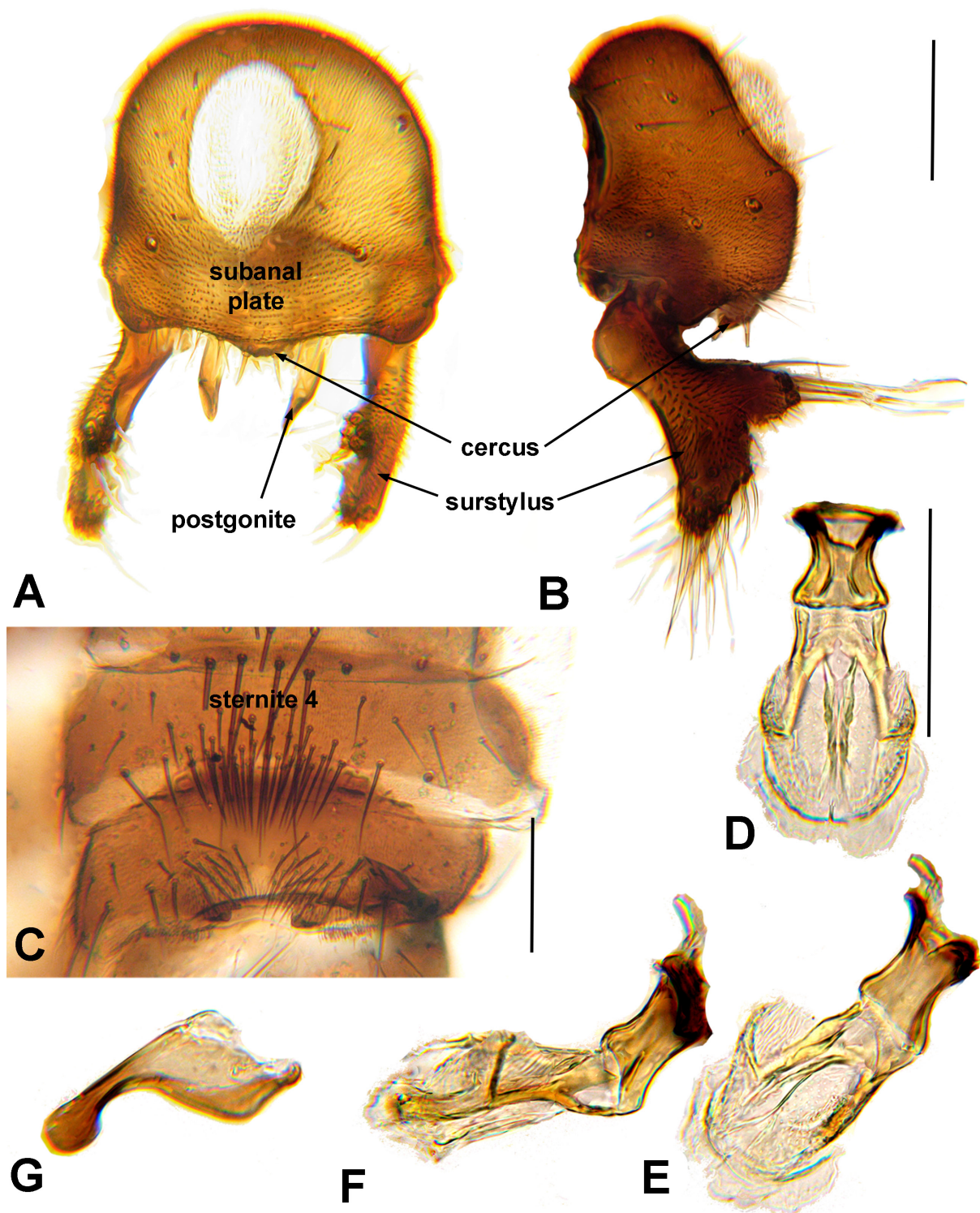

Fig. 18. *Rudolfina pilosa* sp. nov., male terminalia (debu01086241). **A.** Epandrium, surstylus and cercus, caudal view. **B.** Same as preceding, lateral view. **C.** Sternite 5, ventral view. **D.** Phallus and ejaculatory apodeme, dorsal view. **E.** Same as preceding, dorsolateral view. **F.** Same as preceding, lateral view. **G.** Postgonite, lateral view. Scale bars: A–B = 0.10 mm; C = 0.10 mm; D–G = 0.10 mm.

MALE ABDOMEN (Fig. 18). Sternite 3 and 4 with dense cluster of setae posteromedially. Posterior margin of sternite 5 with round teeth on each side of a medial emargination; emargination less than $\frac{1}{6}$ width of sternite and extending $\sim\frac{1}{2}$ length. Transverse part of sternite 6 weakly arcuate. Epandrium with one large pair of setae ventrolaterally, one smaller pair of setae lateral to larger pair, and several setulae scattered over surface; subanal plate broadly continuous below anal opening. Surstylus boot-shaped, posteriorly bent near base, hirsute with 3–5 setae on posterior lobe (heel) and numerous smaller setae on anterior lobe (toe). Cercus fused with epandrium, with distinct seta on ventral margin. Postgonite clavate, with several setulae on dorsal surface. Dorsal sclerite of distiphallus (Fig. 18D–F) without distinct swellings and not extending beyond apex of acrophallus.

Female

Unknown.

Remarks

This species is most similar to *R. newtoni* sp. nov., which also has a setulose male sternite 4 and sternite 5. These species are easily distinguished by the shape of the male surstylus.

Rudolfina remiforma sp. nov.

[urn:lsid:zoobank.org:act:01D37BA9-BF63-4930-9EF1-E1BB6D87C73F](https://zoobank.org/act:01D37BA9-BF63-4930-9EF1-E1BB6D87C73F)

Figs 19–20, 21C

Etymology

The species name is from the Latin for ‘oar-shaped’ and refers to the posterior lobe of the surstylus.

Material examined

Holotype

MEXICO • ♂; Chiapas, 21 mi. N of Bochil; 5500 ft a.s.l.; 18–24 Aug. 1971; A. Newton leg.; pine, oak, *Liquidambar*, human dung; FMNH debu01086286.

Paratypes

MEXICO • 2 ♀♀; same collection data as for holotype; DEBU • 1 ♀; same collection data as for holotype; FMNH.

Description

BODY. Length: 1.4–1.8 mm. Eye height $2.0 \times$ genal height. Head with 4 interfrontal setae and row of 7 small setulae along inner margin of orbital plate. Gena with 1 strong seta and 8 smaller setulae. Acrostichal setulae in 4–6 rows. Costagial seta extending to humeral break; second costal sector shorter than third (20:65); length of M_1 between crossveins dm-cu and r-m $1.4 \times$ dm-cu; CuA_1 stub vein ~ 2.5 – $3.0 \times M_1$ stub vein. Male mid femur with 6 weak setae in ventrobasal cluster. Male mid tibia with ventral comb of 4–5 robust setae on apical $\frac{1}{3}$.

MALE ABDOMEN (Fig. 19). Posterior margin of sternite 5 with small tooth on each side of medial emargination; emargination $\sim\frac{1}{3} \times$ width of sternite 5. Transverse part of sternite 6 weakly arcuate. Epandrium regular, not swollen, with pair of long setae ventrolaterally and another 2–3 smaller pairs dorsolateral to longer pair; subanal plate narrow, incomplete, with narrow medial space. Surstylus with small anterior lobe and elongate posterior lobe; anterior lobe with 4–5 elongate setae apically; posterior lobe paddle-like and drawn out into rounded tip, with posterior margin weakly expanded near mid-length, anterior margin greatly expanded just before midlength, and 1 large seta near base. Cercus small and conical, projecting posteriorly; apical seta present. Postgonite simple, apex narrowly rounded.

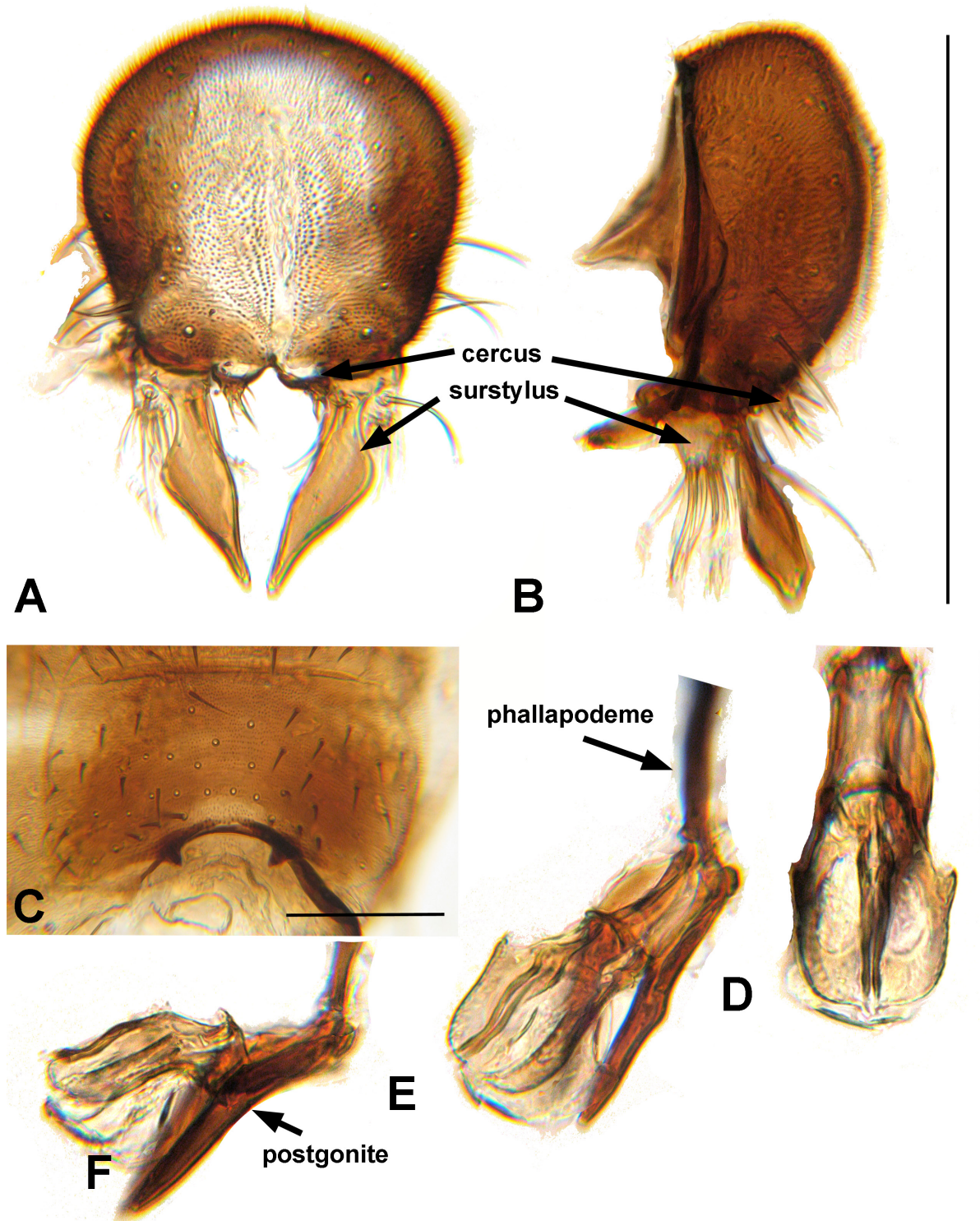

Fig. 19. *Rudolfina remiforma* sp. nov., male terminalia (debu01086286). **A.** Epandrium, surstylus and cercus, caudal view. **B.** Same as preceding, lateral view. **C.** Sternite 5, ventral view. **D.** Phallus and postgonites, dorsal view. **E.** Phallus, postgonites and phallapodeme, dorsolateral view. **F.** Same as preceding, lateral view. Scale bars: A–B = 0.25 mm; C = 0.10 mm; D–F = 0.08 mm.

Dorsal sclerite of distiphallus without distinct swellings and not extending distally beyond acrophallus (Fig. 19D–F).

FEMALE ABDOMEN (Fig. 20). Tergite 7 with posterior margin entire. Medial part of tergite 8 poorly sclerotized or fused with epiproct. Epiproct tulip-shaped, with length of anterior narrowed portion equal or subequal to that of posterior portion. Cercus small, as long as or only slightly longer than flattened apical seta; fused anterolaterally to epiproct. Sternite 7 with posterior margin broadly rounded. Spermathecae lenticular, inner surface with conical projection connecting with duct; paired spermathecae each with duct $\sim 2.0 \times$ length of spermatheca before common duct; single spermathecal duct similar in length.

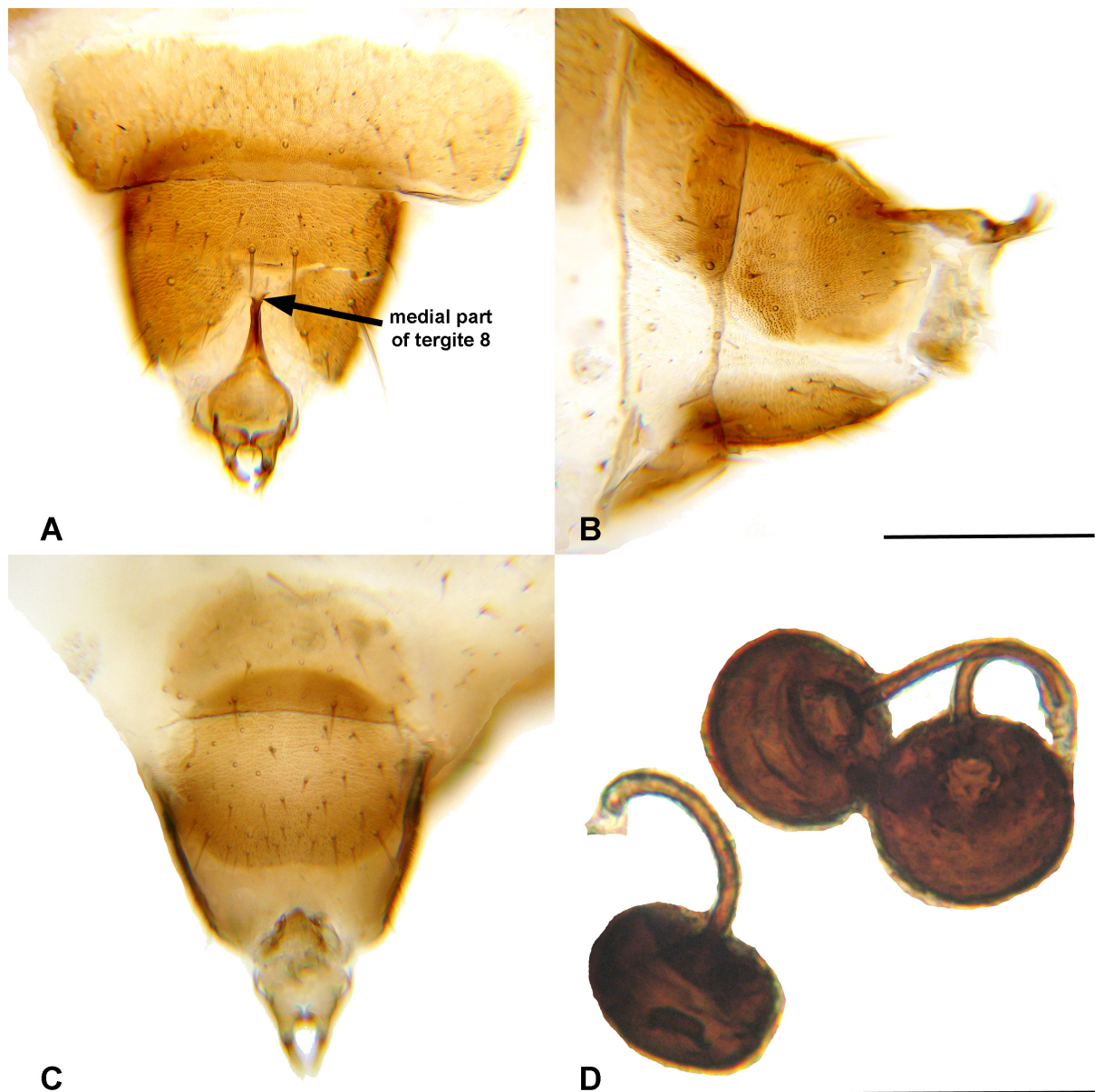

Fig. 20. *Rudolfina remiforma* sp. nov., female terminalia (debu01086288). **A.** Terminal abdominal segments, dorsal view. **B.** Same as preceding, lateral view. **C.** Same as preceding, ventral view. **D.** Spermathecae. Scale bars: A–C = 0.15 mm; D = 0.05 mm.

Remarks

This species is closely related to *R. exuberata* sp. nov. and *R. pauca* sp. nov. and shares the modified epiproct found in those species.

Rudolfina rozkosnyi (Roháček, 1975)

Limosina rozkosnyi – Roháček, 1975: 119.

Material examined

CZECH REPUBLIC • 2 ♂♂, 2 ♀♀; Jezinec Mountains, Velka-Kotlina Valley; 900–1100 m a.s.l.; 16 Aug. 1986; S.A. Marshall leg.; DEBU.

RUSSIA • 1 ♀; Siberia, Altai Reg., ~50 km SE of Teletskoya Lake; 1500 m a.s.l.; 13–15 Jul. 1991; S.A. Marshall leg.; wet area; DEBU.

Description

See Roháček (1975).

Distribution

Palaeartic: Austria, Czech Republic, Germany, Norway, Russia (North European Territory, West Siberia), Slovakia, Sweden.

Remarks

This species is here newly recorded from Siberia on the basis of a single female taken in pan traps near the margin of Teletskoya Lake. Previous Russian records are from the Northern European Territory.

Rudolfina tumida sp. nov.

[urn:lsid:zoobank.org:act:1FA40DBE-98EE-4665-A029-207ABCDE8DD](https://zoobank.org/act:1FA40DBE-98EE-4665-A029-207ABCDE8DD)

Figs 2–3, 21A

Etymology

The species epithet is from the Latin for ‘swollen’, referring to the enlarged epandrium.

Material examined

Holotype

UNITED STATES OF AMERICA • ♂; Wyoming, Uinta Co., 8 mi. SE of Evanston; 7100 ft a.s.l.; 30 Jul.–11 Aug. 1979; S. and J. Peck leg.; sage-grass, riparian, carrion; DEBU debu01086083.

Description

BODY. Length: 1.8–1.9 mm. Eye height $1.0 \times$ genal height. Head with 3 interfrontal setae and 5 small setae along inner margin of orbital plate. Gena with 2 strong setae and 4–5 smaller setulae. Acrostichal setulae in 4–6 rows. Costagial seta length unknown (broken on both sides of holotype); second costal sector shorter than third (35:40). Length of M_1 between crossveins dm-cu and r-m $4.0 \times$ dm-cu; CuA_1 stub vein $\sim 5.0 \times$ M_1 stub vein. Male mid femur basally with 9 strong setae present in ovoid cluster. Male mid tibia with ventral comb of 12–13 robust setae on apical $\frac{2}{3}$.

MALE ABDOMEN (Figs 2–3). Posterior margin of sternite 5 with pair of small teeth on each side of shallow emargination; emargination extending $\frac{1}{4}$ length and $\frac{1}{4}$ width of sternite 5. Transverse part of sternite 6

weakly arcuate. Epandrium swollen, wider than preceding portion of abdomen (denuded on holotype); subanal plate incomplete. Posterior lobe of surstylus elongate, with apex and posterior margin heavily setose; anterobasal lobe broadly rounded and laminate, with distal triangular projection. Cercus ovoid. Postgonite elongate with apex acute. Dorsal sclerite of distiphallus (Fig. 21B–C) with several small swellings along length and extending beyond apex of acrophallus.

Female

Unknown.

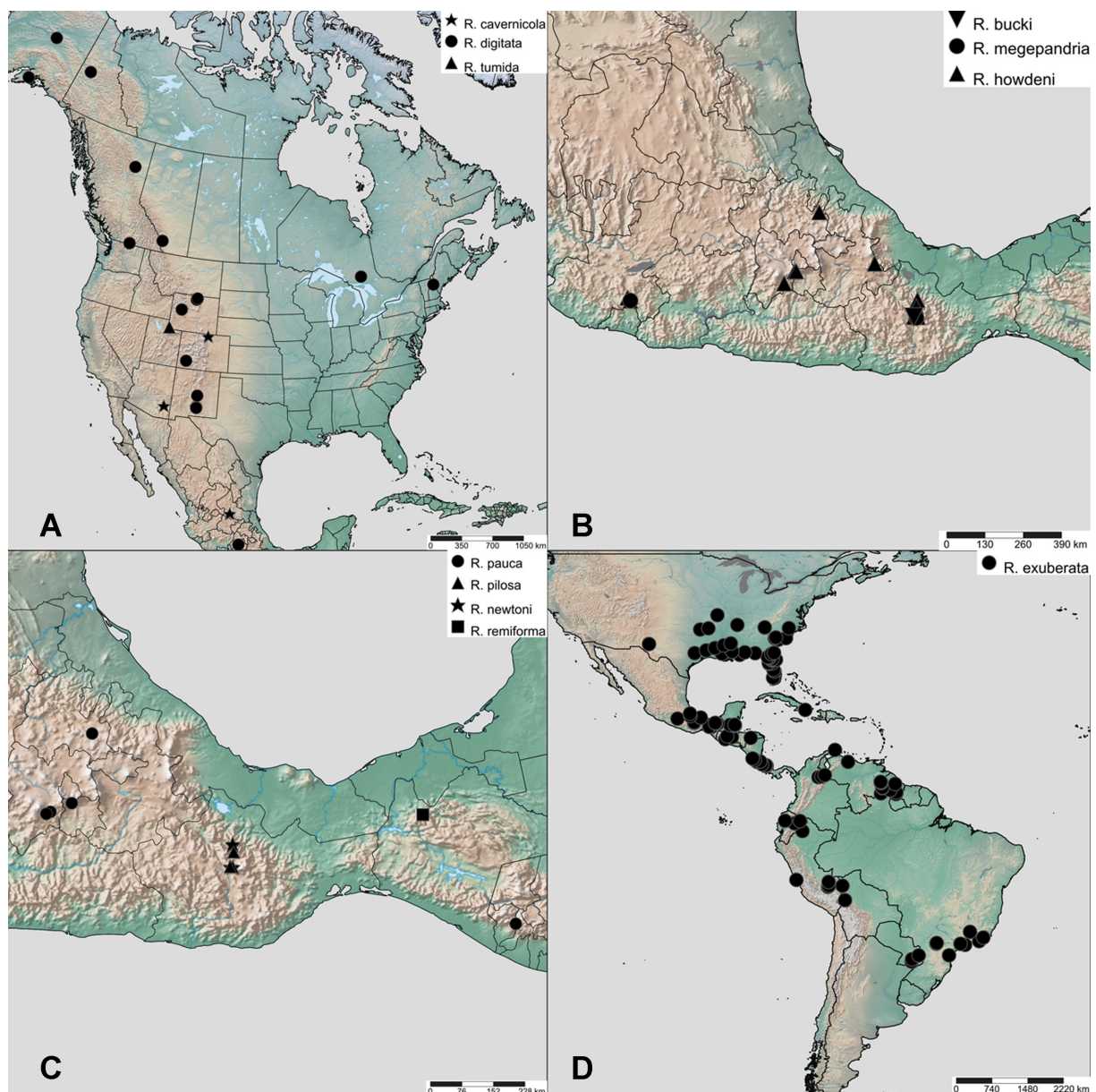

Fig. 21. Distribution of species of New World *Rudolfina* Roháček, 1987. **A.** *R. cavernicola* Marshall & Fitzgerald, 1997, *R. digitata* Marshall, 1991 and *R. tumida* sp. nov. **B.** *R. bucki* sp. nov., *R. megepandria* sp. nov. and *R. howdeni* sp. nov. **C.** *R. pauca* sp. nov., *R. pilosa* sp. nov., *R. newtoni* sp. nov. and *R. remiforma* sp. nov. **D.** *R. exuberata* sp. nov.

Remarks

Rudolfina tumida sp. nov. is distinctive for the uniquely swollen epandrium and large surstylus.

Described species in other genera previously treated as Rudolfina

Trachyopella opuntiae (Richards, 1967)

Leptocera (Trachyopella) opuntiae Richards, 1967: 531.

Remarks

Richards (1967) originally described this species as a *Trachyopella* Duda, 1918 (then a subgenus of *Leptocera* Olivier, 1813), a placement that was followed by Roháček & Marshall (1986) in their review of Holarctic *Trachyopella*. Pitkin (1989) transferred *opuntiae* to *Rudolfina*, in view of its modified female cerci. Examination of type specimens, including male and female terminalia, supports the treatment of this species as a *Trachyopella*.

Leptocera (Acuminiseta) prominens Duda, 1925

Leptocera (Acuminiseta) prominens Duda, 1925: 124.

Remarks

Leptocera (Acuminiseta) prominens was provisionally treated as *Rudolfina* by Roháček *et al.* (2001), who noted that *Acuminiseta* Duda, 1925 does not occur in the New World. This species does not fit into *Rudolfina* as defined here, but belongs elsewhere in the *Archiceroptera* complex and will be treated in a later paper.

Discussion

With the exception of the widespread lowland species *R. exuberata* sp. nov., *Rudolfina* is a Holarctic, and largely Nearctic, genus with highest diversity in the highlands of Mexico. The few records from mountains in Mexico and Guatemala are from an area recognized as a transitional zone between the Nearctic and Neotropical regions, which has been referred to as the Mexican Transition Zone by some authors (e.g., Morrone 2014). The pattern of diversity in *Rudolfina* is consistent with those observed in some bats (Ortega & Arita 1998), copepods (*Aglaodiaptomus* Light, 1938 and *Skistodiaptomus* Light, 1939; see Suarez-Morales *et al.* 2005), passalids (Gutierrez-Velazquez *et al.* 2013) and weevils (García-Navarrete & Morrone 2018). There are no records of *Rudolfina* species other than *R. exuberata* sp. nov. from lowland Guatemala, or any other Neotropical locality. We have studied tens of thousands of specimens collected from throughout Costa Rica over the past thirty years without finding any specimens other than *R. exuberata* sp. nov. that fit *Rudolfina* as currently defined; this reinforces our conclusion that the distribution of *Rudolfina* is effectively bounded southward by the limits of the Nearctic region. The origins of *Rudolfina* are likely to be in western North America, where *R. cavernicola*, the basal-most species, occurs, with the Nearctic and Palaeartic faunas diverging relatively early in *Rudolfina*'s evolutionary history.

Sequence data for the 'barcode' region of cytochrome oxidase I was considered and supported species concepts consistent with the results presented here on the basis of morphology (Paiero 2017), but COI data was available for only three species (*R. digitata*, *R. rozkosnyi* and *R. exuberata* sp. nov.). Other specimens of *Rudolfina* available at this time were mostly collected in pan traps and were not preserved adequately for genetic study.

The number of new species in the University of Guelph insect collection and the apparent novelty of the limited material from other collections suggest that many further new species await discovery. Southern Mexico is especially poorly represented in the current material. We have only a single specimen (*R. cavernicola*) from the Sierra Madre Occidental range and we have seen no *Rudolfina* from the Sierra Madre Oriental. Further collecting efforts in Mexico are therefore likely to greatly improve our understanding of *Rudolfina*.

Acknowledgements

This work was made possible largely through the generosity of Dr. Alfred Newton (FMNH), who kindly allowed SAM to take the Sphaeroceridae from his Mexican residues during the 1980s. Of the 284 non-*R. exuberata* *Rudolfina* specimens studied for this revision, 219 were from these residues. Despite ongoing efforts to obtain further material from throughout the range of *Rudolfina* and related genera, the material collected by Dr. Newton during the early 1970s remains by far the most important collection of Mexican *Rudolfina*. Some of the drawings were prepared by Rebecca Langstaff. Funding for this study was provided by NSERC Discovery grants to SAM and NSERC postgraduate scholarships to SMP.

References

- Cumming J.M. & Wood D.M. 2010. Adult morphology and terminology. In: B.V. Brown (ed.) *Manual of Central American Diptera, Volume 1*: 9–63. NRC Research Press, Ottawa, Ontario.
- García-Navarrete P.G. & Morrone J.J. 2018. Testing the biogeographical regionalization of the Mexican Transition Zone based on the distribution of Curculionidae (Insecta: Coleoptera). *Zootaxa* 4530 (1): 1–99. <https://doi.org/10.11646/zootaxa.4530.1.1>
- Goloboff P.A., Farris J. & Nixon K. 2008. TNT: a free program for phylogenetic analysis. *Cladistics* 24: 774–786. <https://doi.org/10.1111/j.1096-0031.2008.00217.x>
- Gutierrez-Velazquez A., Rojas-Soto O., Reyes-Castillo P. & Halffter G. 2013. The classic theory of Mexican Transition Zone revisited: the distributional congruence patterns of Passalidae (Coleoptera). *Invertebrate Systematics* 27: 282–293. <https://doi.org/10.1071/IS12056>
- Maddison W.P. & Maddison D.R. 2017. Mesquite: a modular system for evolutionary analysis. Version 3.2. Available from <https://www.mesquiteproject.org/> [accessed 29 Jan. 2017].
- Marshall S.A. 1982. *A Review of the Nearctic Limosininae (Diptera, Sphaeroceridae), with Revisions of Selected Genera*. PhD thesis, University of Guelph, Canada.
- Marshall S.A. 1991. *Rudolfina digitata* sp. nov., a new Nearctic sphaerocerid with a disjunct alpine-arctic distribution. *The Canadian Entomologist* 123: 621–626. <https://doi.org/10.4039/Ent123621-3>
- Marshall S.A. & Buck M. 2010. Sphaeroceridae (Small dung flies). In: Brown B.V., Borkent A., Cumming J.M., Wood D.M., Woodley N.E. & Zumbado M.A. (eds) *Manual of Central American Diptera*: 1165–1187. NRC Research Press, Ottawa, Ontario.
- Marshall S.A. & Cui Y. 2005. Systematics of *Robustagramma*, a new genus of New World Sphaeroceridae (Diptera). *Zootaxa* 1026: 1–122. <https://doi.org/10.11646/zootaxa.1026.1.1>
- Marshall S.A. & Fitzgerald S. 1997. *Rudolfina cavernicola*, a new species of cave-associated Sphaeroceridae (Diptera) from Colorado and Arizona. *Proceedings of the Entomological Society of Washington* 99: 641–644.
- Marshall S.A. & Richards O.W. 1987. Sphaeroceridae. In: McAlpine J.F., Peterson B.V., Shewell G.E., Teskey H.J., Vockeroth J.R. & Wood D.M. (eds) *Manual of the Nearctic Diptera, Part 2*: 601–685. Agriculture Canada, Ottawa.

- Morrone J.J. 2014. Biogeographical regionalization of the Neotropical region. *Zootaxa* 3782 (1): 1–110. <https://doi.org/10.11646/zootaxa.3782.1.1>
- Nixon K.C. 2002. WinClada ver. 1.00.08, published by the author, Ithaca, NY, USA.
- Ortega J. & Arita H.T. 1998. Neotropical-Nearctic limits in Middle America as determined by distributions of bats. *Journal of Mammology* 79 (3): 72–783. <https://doi.org/10.2307/1383088>
- Paiero S.M. 2017. *A Review of the Archiceroptera Papp Genus Complex (Diptera: Sphaeroceridae: Limosiniinae)*. PhD thesis, University of Guelph, Canada.
- Pitkin B.R. 1989. A review of the Sphaeroceridae (Diptera) described by O.W. Richards. *Occasional Papers on Systematic Entomology, London* 6: 1–44.
- Richards O.W. 1967. On a collection of Sphaeroceridae (Diptera) from the Galapagos Islands. *Annals and Magazine of Natural History (Series 13)* 9: 531–535.
- Roháček J. 1975. Three new species of the genus *Limosina* Macq. (Sphaeroceridae, Diptera) from Czechoslovakia. *Scripta Facultatis Scientiarum Naturalium Universitatis J.E. Purkynianae Brunensis, Biologia* 2 (5): 115–126.
- Roháček J. 1982. A monograph and reclassification of the previous genus *Limosina* Macquart (Diptera, Sphaeroceridae) of Europe, Part I. *Beiträge zur Entomologie* 32: 195–282. <https://doi.org/10.21248/contrib.entomol.32.2.195-282>
- Roháček J. 1983. A monograph and reclassification of the previous genus *Limosina* Macquart (Diptera, Sphaeroceridae) of Europe, Part II. *Beiträge zur Entomologie* 33: 3–195. <https://doi.org/10.21248/contrib.entomol.33.1.3-195>
- Roháček J. 1985. A monograph and reclassification of the previous genus *Limosina* Macquart (Diptera, Sphaeroceridae) of Europe, Part IV. *Beiträge zur Entomologie* 35: 101–179. <https://doi.org/10.21248/contrib.entomol.35.1.101-179>
- Roháček J. 1987. Replacement name for *Rudolfia* Roháček, 1982 (Diptera, Sphaeroceridae), with first record of *R. rozkosnyi* from northern Europe. *Acta Entomologica Bohemoslovaca* 84: 474–476.
- Roháček J. 1998. Family Sphaeroceridae. In: Papp L. & Darvas B. (eds) *Contributions to a Manual of Palaearctic Diptera. Vol. 3., Higher Brachycera*: 463–496. Science Herald, Budapest.
- Roháček J. & Marshall S.A. 1986. *The genus Trachyopella Duda (Diptera, Sphaeroceridae) of the Holarctic Region*. Monografie III. Museo Regionale di Scienze Naturali, Torino.
- Roháček J., Marshall S.A., Norrbom A.L., Buck M., Quiros D.I. & Smith I. 2001. *World Catalog of Sphaeroceridae (Diptera)*. Slezské zemské muzeum, Opava, Czech Republic.
- Shorthouse D.P. 2010. SimpleMappr, an online tool to produce publication-quality point maps. Available from <http://www.simplemappr.net> [accessed 29 Jan. 2017].
- Smith I.P. & Marshall S.A. 2004. A review of the New World genus *Pterogramma* Spuler and a revision of the *Pterogramma sublugubrinum* group (Diptera: Sphaeroceridae: Limosiniinae). *Contributions in Science* 499: 1–163.
- Su L., Xu J. & Cong G. 2017. A new species of the genus *Rudolfina* Roháček, 1987 (Diptera, Sphaeroceridae) from North-east China, with a key to the known Holarctic species of *Rudolfina*. *Oriental Insects* 51 (4): 391–396. <https://doi.org/10.1080/00305316.2017.1315975>

Suarez-Morales E., Reind J.W. & Elias-Guitierrez M. 2005. Diversity and distributional patterns of Neotropical freshwater copepods (Calanoida: Diaptomidae). *International Review of Hydrobiology* 90 (1): 71–83. <https://doi.org/10.1002/iroh.200410742>

Manuscript received: 13 June 2019

Manuscript accepted: 25 September 2019

Published on: 16 January 2020

Topic editor: Gavin Broad

Desk editor: Kristiaan Hoedemakers

Printed versions of all papers are also deposited in the libraries of the institutes that are members of the *EJT* consortium: Muséum national d'histoire naturelle, Paris, France; Meise Botanic Garden, Belgium; Royal Museum for Central Africa, Tervuren, Belgium; Royal Belgian Institute of Natural Sciences, Brussels, Belgium; Natural History Museum of Denmark, Copenhagen, Denmark; Naturalis Biodiversity Center, Leiden, the Netherlands; Museo Nacional de Ciencias Naturales-CSIC, Madrid, Spain; Real Jardín Botánico de Madrid CSIC, Spain; Zoological Research Museum Alexander Koenig, Bonn, Germany; National Museum, Prague, Czech Republic.