



Global ecosystems and fire: Multi-model assessment of fire-induced tree-cover and carbon storage reduction

Gitta Lasslop¹ | Stijn Hantson² | Sandy P. Harrison³ | Dominique Bachelet⁴ | Chantelle Burton⁵ | Matthias Forkel⁶ | Matthew Forrest¹ | Fang Li⁷ | Joe R. Melton⁸ | Chao Yue⁹ | Sally Archibald¹⁰ | Simon Scheiter¹ | Almut Arneith¹¹ | Thomas Hickler^{1,12} | Stephen Sitch¹³

¹Senckenberg Biodiversity and Climate Research Centre, Frankfurt am Main, Germany

²Department of Earth System Sciences, University of California Irvine, Irvine, CA, USA

³School of Archaeology, Geography and Environmental Sciences (SAGES), University of Reading, Reading, UK

⁴Oregon State University, Corvallis, OR, USA

⁵Met Office Hadley Centre, Exeter, UK

⁶Environmental Remote Sensing Group, Institute of Photogrammetry and Remote Sensing, Technische Universität Dresden, Dresden, Germany

⁷International Center for Climate and Environmental Sciences, Institute of Atmospheric Physics, Chinese Academy of Sciences, Beijing, China

⁸Climate Research Division, Environment Canada, Victoria, BC, Canada

⁹State Key Laboratory of Soil Erosion and Dryland Farming on the Loess Plateau, Northwest A&F University, Yangling, Shaanxi, People's Republic of China

¹⁰Centre for African Ecology, School of Animal, Plant and Environmental Sciences, University of the Witwatersrand, Johannesburg, South Africa

¹¹Karlsruhe Institute of Technology, Institute of Meteorology and Climate Research, Atmospheric Environmental Research, Garmisch-Partenkirchen, Germany

¹²Department of Physical Geography, Goethe University, Frankfurt am Main, Germany

¹³College of Life and Environmental Sciences, University of Exeter, Exeter, UK

Correspondence

Gitta Lasslop, Senckenberg Biodiversity and Climate Research Centre, Senckenberganlage 25, Frankfurt am Main, Germany.
Email: gitta.lasslop@senckenberg.de

Funding information

National Natural Science Foundation of China, Grant/Award Number: 41475099 and 41875137; Deutsche Forschungsgemeinschaft, Grant/Award Number: 338130981 and SCHE 1719/2-1; Newton Fund; Helmholtz Association; H2020 European Research Council, Grant/Award Number: 694481

Abstract

In this study, we use simulations from seven global vegetation models to provide the first multi-model estimate of fire impacts on global tree cover and the carbon cycle under current climate and anthropogenic land use conditions, averaged for the years 2001–2012. Fire globally reduces the tree covered area and vegetation carbon storage by 10%. Regionally, the effects are much stronger, up to 20% for certain latitudinal bands, and 17% in savanna regions. Global fire effects on total carbon storage and carbon turnover times are lower with the effect on gross primary productivity (GPP) close to 0. We find the strongest impacts of fire in savanna regions. Climatic conditions in regions with the highest burned area differ from regions with highest absolute fire impact, which are characterized by higher precipitation. Our estimates of fire-induced vegetation change are lower than previous studies. We attribute these differences to different definitions of vegetation change and effects of anthropogenic land use, which were not considered in previous studies and decreases the impact of fire on tree cover. Accounting for fires significantly improves the spatial

This is an open access article under the terms of the Creative Commons Attribution-NonCommercial License, which permits use, distribution and reproduction in any medium, provided the original work is properly cited and is not used for commercial purposes.

© 2020 The Authors. *Global Change Biology* published by John Wiley & Sons Ltd

patterns of simulated tree cover, which demonstrates the need to represent fire in dynamic vegetation models. Based upon comparisons between models and observations, process understanding and representation in models, we assess a higher confidence in the fire impact on tree cover and vegetation carbon compared to GPP, total carbon storage and turnover times. We have higher confidence in the spatial patterns compared to the global totals of the simulated fire impact. As we used an ensemble of state-of-the-art fire models, including effects of land use and the ensemble median or mean compares better to observational datasets than any individual model, we consider the here presented results to be the current best estimate of global fire effects on ecosystems.

KEYWORDS

global fire modelling, terrestrial carbon cycle, vegetation modelling, wildfires

1 | INTRODUCTION

Fire has been a part of the earth system since vegetation first spread onto land (Scott & Glasspool, 2006). It is a key process for understanding land carbon storage (Bond-Lamberty, Peckham, Ahl, & Gower, 2007; Yue et al., 2016), distribution of forests (Bond, Woodward, & Midgley, 2005; Lasslop, Brovkin, Reick, Bathiany, & Kloster, 2016; Sankaran et al., 2005; Thonicke, Venevsky, Sitch, & Cramer, 2001) and biodiversity (He, Lamont, & Pausas, 2019; Wirth, 2005) globally and regionally. The capacity of land ecosystems to take up and store carbon in vegetation and soils is a fundamental component of climate change mitigation strategies (Bastin et al., 2019; Brancalion et al., 2019; Canadell & Raupach, 2008; Grassi et al., 2017). Due to the vulnerability of vegetation carbon pools to fire, especially the large pools in forests, quantitative understanding of the impact of fire on carbon storage and tree cover is needed but difficult to obtain due to interactions with other factors, such as drought or herbivory.

Experimental and modelling approaches have been used to increase our understanding of fire effects on different aspects of the terrestrial biosphere. The effects of fire at the local scale can be observed on experimental burn plots (Furley, Rees, Ryan, & Saiz, 2008; Higgins et al., 2007; Pellegrini et al., 2017) or by comparing recently

burned versus unburned mature stands (Harden, Mack, Veldhuis, & Gower, 2002). Impacts on biomass, individual trees, vegetation structure, community composition and soil carbon are measured in exclusion plots and are compared with those from reference plots (Devine, Stott, McDonald, & Maclean, 2015; Higgins et al., 2007). However, such experiments are site-specific and usually established in regions where the impact of fire is strong and readily apparent in the vegetation structure. Satellite data can be used to assess the impact of individual fire events in larger areas by comparing the remotely sensed vegetation parameters before and after a fire (Liu, Ballantyne, & Cooper, 2019; Staal et al., 2018). This estimation of instantaneous effects differs from the long-term average effect of fires (Figure 1), which is the subject of this study. In regions of frequent burning the vegetation before fire does not represent the vegetation state without fire because the equilibrium state of vegetation is always strongly affected by fire. The instantaneous effect, that is, the difference between the state before and directly after the fire, is therefore lower than the effect of long-term fire exclusion. In regions with low fire occurrence, that is, with a long fire return interval, the vegetation state after a fire is a rare ecosystem state as the vegetation usually has ample time to recover before the next fire. In this case, the instantaneous effects are larger than the long-term average fire effects. Although these observation-based estimates of

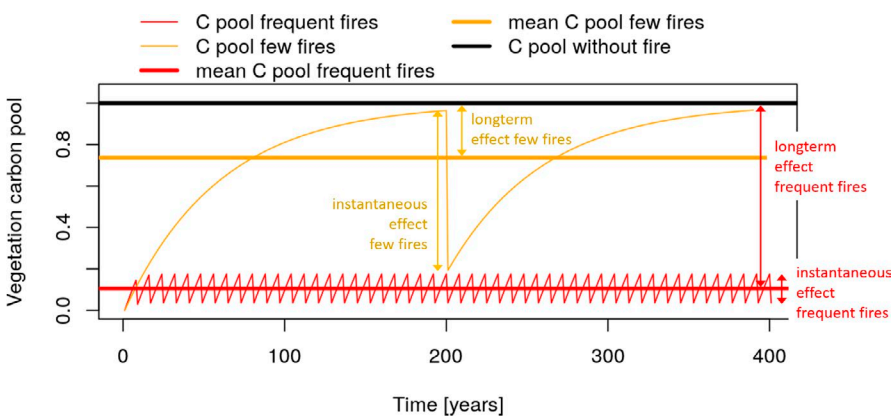

FIGURE 1 Schematic comparison of long-term (as estimated in this study) and instantaneous effects of fires on vegetation carbon pools for fire regimes with few or with frequent fires. The comparison assumes an 80% reduction in the carbon pool during each fire and a carbon pool of 1 without fires for both fire regimes

fire effects are informative, a large scale or global quantification of long-term fire effects on vegetation and the carbon cycle can only be achieved using models.

Models allow us to estimate the impact of fire by comparing a reference simulation that includes the effects of fire to a second simulation without fire. Bond et al. (2005) were the first to provide a global picture of the impact of fire on the vegetation distribution for the 20th century using the Sheffield Dynamic Global Vegetation Model. They found strong impacts of fire, with an estimated doubling of forest area without fire. Poulter et al. (2015) also studied the effect of fire on vegetation globally by prescribing satellite burned area datasets within the LPJ vegetation model. They found a smaller increase in tree covered area of only 15%–25%. As they use tree cover instead of forest cover (which was defined as tree cover > 80% by Bond et al., 2005) to quantify the effect, the results are not directly comparable with those of Bond et al. (2005). Both studies included the effects of humans on climate in their forcing datasets but not the effects of humans on vegetation in terms of land use change and therefore do not provide a picture of present-day ecosystems.

Several studies exist, which use global vegetation models to estimate the fire impact on the carbon cycle but they show conflicting results. Li, Bond-Lamberty, and Levis (2014) evaluated the role of fire on carbon fluxes using the Community Land Model (CLM) and found that fire decreases the land carbon uptake by 1 Pg C/year and the net primary productivity (NPP) by 1.9 Pg C/year. Much lower effects on the land carbon uptake were obtained with the ORCHIDEE vegetation model (Yue, Ciais, Cadule, Thonicke, & van Leeuwen, 2015). In contrast, fire increased NPP in the aforementioned study of Poulter et al. (2015) using the LPJ vegetation model. This arose because grass cover increased due to fire and grasslands had higher productivity compared to forests. So far, there is no systematic comparison of a model ensemble, which would allow evaluation of the robustness of model simulations and identification of key uncertainties of estimating fire impacts.

The FireMIP project (Hantson et al., 2016; Rabin et al., 2017) provides a framework to compare fire impacts on vegetation and carbon cycling based on state-of-the-art fire-vegetation models driven with the same forcing datasets. The models were all developed in recent years with insights from global burned area satellite datasets and advances in process representation. Important developments are related to anthropogenic influences or different types of fuels (Hantson et al., 2016). The models are able to reproduce the observed main spatial gradients of burned area for present day well (Forkel, Andela, et al., 2019; Hantson et al., 2020; Teckentrup et al., 2019). The models, however, diverge with respect to trends over the last decades (Andela et al., 2017; Teckentrup et al., 2019) and the uncertainty in observed global burned area trends is still high (Forkel, Dorigo, et al., 2019). We therefore exploit the capability of the models to represent the global spatial patterns as observed by satellite data to assess fire impacts on vegetation and the global carbon cycle.

The present study quantifies the global-scale impact of fire on tree cover and the carbon cycle under present-day conditions

(2001–2012) based on a simulation ensemble of seven global fire-vegetation models, which include effects of anthropogenic land use. We assess the confidence in the modelled results based on a comparison of the model ensemble results with observation-driven datasets, consistency between models, process representation and the current level of process understanding. In the discussion, we address causes for differences to previous studies, model uncertainties, useful model developments and the wider implications of our results in light of recent literature.

2 | MATERIALS AND METHODS

2.1 | Models and simulations

We quantified the impact of fire on vegetation and the carbon cycle as the difference between simulations with and without fire, conducted with seven fire-enabled global vegetation models provided by the Fire Model Intercomparison Project (FireMIP: Hantson et al., 2016; Rabin et al., 2017). The simulation including fire is the FireMIP reference experiment (SF1 in Rabin et al., 2017). The simulation without fire (SF2_WWF in Rabin et al., 2017) is a sensitivity experiment in which fire is turned off. This simulation was run for the same time period and with the same forcing as the historical reference simulation SF1. Both simulations started with a spin-up simulation in which the model was run until the slowest soil pool was in equilibrium, defined as a change of <1% within 50 years. During the spin-up, climate and lightning data were recycled over the years 1901–1920, all other forcing factors (atmospheric CO₂, human population density, land use and land cover) were kept constant at the values of the first year (see Rabin et al., 2017 for details). The models were then run transiently from 1701 to 2012 using the same forcing. Although the transient experiment with changes in land use, atmospheric CO₂ and population density was run from 1701 onwards, varying values of climate and lightning are only used after 1900, due to the availability of transient forcing datasets. Two models (CLM, CLASS-CTEM) started the transient simulation in 1850 and 1861, respectively, but as the influence of the forcing factors on the simulations is rather small before 1900, this inconsistency does not have a strong impact on the results.

The FireMIP models differ in their underlying assumptions and differences between models reflect the uncertainty in modelling fire occurrence and fire impacts at global scale. The models range from largely empirically based treatments of burned area, which are based on scaling functions related to moisture, fuel and ignition limitations, to process-based models, which represent ignitions, fire spread and duration. The impacts of fire, for example, vegetation mortality and carbon pool combustion, are computed as a combination of the area burned with constant, usually plant functional type (PFT)-dependent parameters, for the simple models or depend on moisture contents and fire intensity in the more complex models.

The fire models also differ in which components of the model (e.g. vegetation composition, specific carbon pools) are affected

by fire (Figure 2; also see Rabin et al., 2017 for details). They all simulate fire impact on the litter pool (C litter), and most of them simulate impacts on vegetation carbon pools (C Veg) and thus indirectly on productivity (GPP). Two models (CLM and LPJ-GUESS-SIMFIRE-BLAZE) include an interactive nitrogen cycle. Only one of the models (CLM) explicitly simulates anthropogenic management fires (i.e. agricultural and deforestation fires) and diagnoses peatland fire emissions (peatland carbon stocks are however not represented, the peatland emissions therefore do not impact the results we show here). More details are documented in Rabin et al. (2017). Only four of the models (JULES-INFERNO, JSBACH-SPITFIRE, LPJ-GUESS-SIMFIRE-BLAZE, LPJ-GUESS-SPITFIRE) allow fire impacts on vegetation distribution, the other models prescribe the fraction of a grid cell covered by specific vegetation types. Although the original FireMIP versions of JSBACH-SPITFIRE and JULES-INFERNO did not include the coupling between fire and dynamic biogeography (Rabin et al., 2017), we used updated model versions in this study to increase the number of models including this effect. Several changes in the JSBACH-SPITFIRE model were made since the first round of FireMIP simulations. These include a reparameterization of human ignitions, inclusion of the desert fraction for the computation of average fuel load, changes in the rate of spread equations and an NPP threshold for the establishment of trees. The simulated burned area is displayed in Figure S2. The computation of the fire impacts remained unchanged. For detailed documentation, see Supporting Information S2 for JSBACH-SPITFIRE and Burton et al. (2019) for JULES-INFERNO.

We quantify the impact of fire on ecosystem processes, vegetation dynamics and carbon cycling for the years 2001–2012 because high-quality satellite datasets of burned area are available for this period. The year 2001 is the first year with data from the Moderate-resolution Imaging Spectroradiometer (MODIS), which is the basis for the burned area and tree cover datasets we used here. The year 2012 is the last year with simulation outputs from all models. The satellite burned area datasets were used by many modelling groups during model development. The models show the smallest inter-model differences in simulated burned area for

this interval, which is therefore also the time period in which the simulated fire impacts are expected to be best constrained. The spatial variability in burned area is better captured by the model ensemble median compared to the model ensemble mean. The latter shows a higher mean absolute deviation from the remote sensing datasets and lower spatial variability, for example, the virtual absence of fire in the rain forests is not captured by the ensemble mean (Figure S3a). The median is generally more robust to outliers than the mean. We therefore use the model ensemble median of burned area throughout the manuscript. This choice does not have any effect on our conclusions.

2.2 | Datasets

As detailed model evaluations for burned area have been performed in other studies (Andela et al., 2017; Forkel, Andela, et al., 2019; Hantson et al., 2020; Teckentrup et al., 2019), we include the burned area map of the model ensemble only in the supplement (Supporting Information S3; Figure S3), together with the mean of three satellite burned area products: GFED4 (Giglio, Randerson, & van der Werf, 2013), GFED4s (Randerson, Chen, van der Werf, Rogers, & Morton, 2012) and the FireCCI50 (European Space Agency Climate Change Initiative, Fire_CCI, version 50; Chuvieco et al., 2018).

We use a satellite tree cover product, and observation-driven datasets on the carbon cycle components and compare global spatial distribution and latitudinal gradients to the model simulations with and without fire. We compared modelled tree cover to the MODIS collection 6 MOD44B canopy cover product (Townsend et al., 2011). The tree cover in this remote sensing dataset saturates at ca. 80% while models assume a maximum of 100%. An 80% tree cover in terms of canopy cover as reported in that dataset corresponds to 100% forest cover in terms of crown cover (Hansen et al., 2013) as assumed by the models. Therefore we rescaled the remote sensing dataset by dividing by the maximum tree cover (approx. 80%) of the same dataset regridded to the model resolution. We again used the average over the years 2001–2012. We also used this dataset

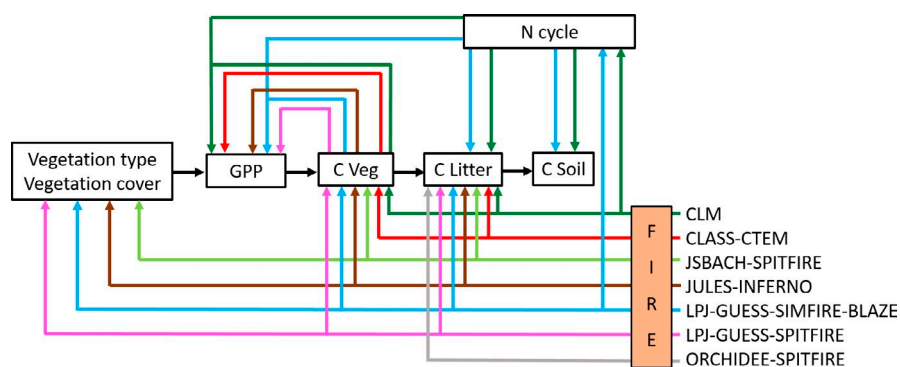

FIGURE 2 Representation of the impact of fire on different components of the carbon/nutrient cycle in the FireMIP models. Note that INFERNO does not have explicit litter pools but uses two of four soil pools instead. C Litter, carbon stored in litter; C Soil, carbon stored in soil; C Veg: carbon stored in vegetation; CLM, Community Land Model; GPP, gross primary production; LAI, leaf area index; NPP, net primary production; N cycle, nitrogen cycle

to derive a mask for tropical savanna regions. Savanna regions are characterized by the highest burned areas worldwide, and impacts of fire are therefore expected to be particularly large. Tropical savanna regions were defined as regions between latitudes of 30°S and 30°N and with rescaled tree cover between 10% and 60%. The limits are tree cover values that show low frequency in the tropical region and were used as threshold between grasslands, savannas and forests before (Hirota, Holmgren, Van Nes, & Scheffer, 2011; Staver, Archibald, & Levin, 2011).

We used a compilation of observation-driven estimates of mean annual GPP, vegetation carbon content (C Veg, i.e. above- and below-ground biomass), total ecosystem carbon content (C Total, i.e. vegetation and soil carbon, C Soil), and of ecosystem carbon turnover time τ defined as (Carvalhais et al., 2014):

$$\tau = \frac{C_{\text{Veg}} + C_{\text{Soil}}}{\text{GPP}} = \frac{C_{\text{Total}}}{\text{GPP}}. \quad (1)$$

The data compilation provides, for each variable, an ensemble of estimates to quantify uncertainties. We used the median estimate and the 25% and 75% percentiles of the ensemble. The GPP dataset was derived by upscaling in situ eddy-covariance-derived estimates of GPP to the globe using satellite data and a suite of machine learning models (Jung et al., 2011). Global estimates of vegetation carbon content were derived from satellite-derived maps of above-ground forest biomass (Carvalhais et al., 2014; Saatchi et al., 2011) and from empirical estimates of below-ground and herbaceous biomass (Carvalhais et al., 2014). Total soil carbon was estimated from two soil databases and by extrapolating the distribution of carbon until the full soil depth using two empirical approaches (Carvalhais et al., 2014). The definition of ecosystem carbon turnover time follows the assumption that carbon pools are in steady state. This assumption is not valid on short (seasonal to annual) time scales if ecosystem disturbances such as fires cause large carbon emissions followed by a stronger ecosystem carbon uptake through vegetation regrowth. The computation of the ratio (Equation 1) is sensitive to spatial aggregation (see Figure S1), first aggregating to global values leads to much lower turnover time estimates than computing the ratio first at grid cell level and aggregating to the global value subsequently. Hence, we used the ecosystem turnover time as a diagnostic to quantify the effects of fire on the average ecosystem carbon cycling on a decadal time scale and the coarsest model grid scale ($2.8125^\circ \times 2.8125^\circ$).

2.3 | Data processing

We used the climate data operators (version 1.9.3; www.mpimet.mpg.de/cdo) and the statistical software R, version 3.4.4 (R Core Team, 2018), for data processing and plotting. We used the FireMIP model output of carbon stored in litter, vegetation and soil, gross primary productivity (GPP), burned area and land cover fraction. For all variables, the data were averaged over the years 2001–2012 and then aggregated to the spatial resolution of the coarsest model (CLASS-CTEM,

$2.8125^\circ \times 2.8125^\circ$). We then derived total carbon, turnover times and tree cover. Total carbon was computed as the sum of vegetation and soil carbon (soil carbon includes the litter carbon). Ecosystem turnover time was computed from model outputs using Equation (1) following Carvalhais et al. (2014). We did not include grid cells where the decadal average GPP was less than 10 g C/year in the computation of turnover times (consistent with Carvalhais et al., 2014) and only included grid cells in the comparison where both the observations and the models provided an estimate. The definition of vegetation types differs between the models. We therefore used the tree cover as an integrated measure of changes in vegetation type to simplify the comparison across models. Tree cover for models including dynamic biogeography (JULES-INFERN0, JSBACH-SPITFIRE, LPJ-GUESS-SIMFIRE-BLAZE, LPJ-GUESS-SPITFIRE; see Figure 2) was computed as the sum of all tree PFT cover fractions (excluding shrubs if present).

We quantify the difference between simulations and observation-driven datasets by the normalized mean error (NME; Kelley et al., 2013). We examine the impact of fire in terms of the spatial distribution and global changes in vegetation and carbon cycle components between the reference SF1 including fire and SF2_WWF (without fire) simulations. We use the model ensemble median, as it is more robust to outliers, and include the first and third quartiles for the latitudinal gradients and global values. The only exception to this approach is for tree cover changes where we use the mean due to the small number of models providing fire-induced tree cover changes (only four). Area weighting was applied to compute global values. We report the inter-model correlations between the different parameters of global changes due to fire. For the intra-model correlations of individual models, we correlate the temporal averages of the grid cells. For the latter, only grid cells were included where burned area was greater than zero in the reference simulation.

3 | RESULTS

3.1 | Fire impact on vegetation distribution

Four models simulate the distribution of vegetation types dynamically: LPJ-GUESS-SPITFIRE, LPJ-GUESS-SIMFIRE-BLAZE, INFERN0 and JSBACH-SPITFIRE (Figure 2) and were used to assess the impact of fire on tree cover. Including fire significantly decreases the NME between models and observations from 0.47 to 0.39 for the ensemble mean, as well as for each individual model (Table 1). The models capture the spatial patterns of tree cover distribution (Figure 3a). They tend to have slightly higher tree cover than the MODIS dataset, except for the southern extra-tropics where the satellite dataset shows a higher tree cover (Figure 3b).

Comparing simulations with and without fire shows that the models simulate, on average, a 10% decrease in tree cover when fire is taken into account (individual model results vary between 3% and 25%, see Figure S4). The largest simulated impact of fire on tree cover occurs in the tropics (reduction by 3 million km², between 0.5 and 6.7 million km² for individual models). A large part

TABLE 1 Normalized mean error (NME) between observation-driven datasets and model simulations with and without fire for gross primary productivity (GPP), carbon stored in vegetation (C Veg), total land carbon storage (C Total) and tree cover (TC)

Model	GPP with fire	GPP no fire	C Veg with fire	C Veg no fire	C Total with fire	C Total no fire	TC with fire	TC no fire
CLM	0.585	0.48079	0.936	0.947	2.408***	2.783***		
CLASS-CTEM	0.434	0.422	0.703	0.687	1.087	1.047		
INFERNO	0.550	0.538	0.712	0.721	1.102*	1.046*	0.755**	0.801**
JSBACH-SPITFIRE	0.550	0.550	0.720	0.736	1.976	1.964	0.532**	0.595**
LPJ-GUESS-SIMFIRE-BLAZE	0.376	0.391	0.553***	0.731***	0.929*	0.884*	0.436*	0.463*
LPJ-GUESS-SPITFIRE	0.474	0.475	0.937	0.968	1.047	1.026	0.619**	0.694**
ORCHIDEE-SPITFIRE					1.236	1.208		
Ensemble median	0.283	0.285	0.535*	0.573*	0.886***	0.819***		
Ensemble mean	0.25	0.263	0.549**	0.591**	0.909**	0.877**	0.389***	0.471***

Note: Asterisks indicate significance level of NME changes: * $p < .1$, ** $p < .5$, *** $p < .01$.

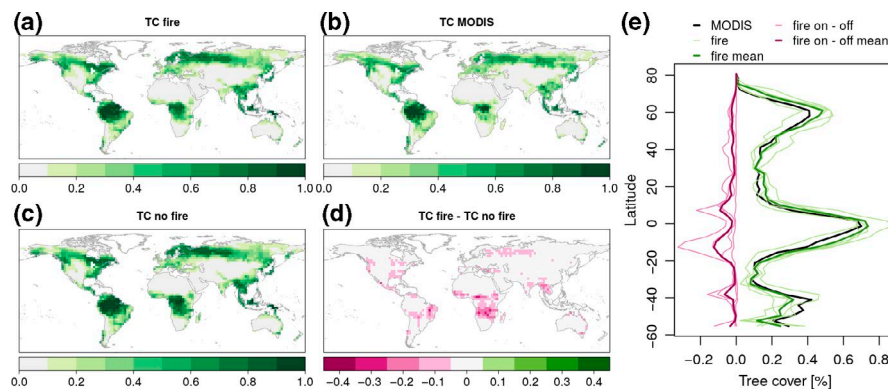
**FIGURE 3** Model mean of LPJ-GUESS-SPITFIRE, LPJ-GUESS-SIMFIRE-BLAZE, JSBACH-SPITFIRE and JULES-INFERNNO. (a) Tree cover (TC) for simulations including effects of fire, (b) observed TC, (c) TC for simulations without fire, (d) impact of fire on TC, that is, difference between (a) and (c), (e) latitudinal patterns of the MODIS TC, modelled TC of the reference simulation, and difference between the simulation with and without fire (models delta). MODIS, Moderate-resolution Imaging Spectroradiometer

84% (between 63% and 89%) of this tree cover decrease is located in savanna regions surrounding the tropical rainforests (Figure 3). In these regions, burned area is highest and the simulated burned area compares well with the observations (Figure S3). For extra-tropical regions, the simulations show a tree-cover reduction of 1.2 Mio. km² (individual model results between 0.04 and 2.6 Mio. km²).

We explore the effects of anthropogenic land cover and model complexity as these are possible reasons for differences to and between earlier studies. The change in tree cover for a given burned area fraction decreases with increasing land use fraction (Figure S5a). We estimate a fire-induced reduction in tree cover of 16% without anthropogenic land use for the model ensemble mean (Supporting Information S4), which means that anthropogenic land cover change strongly limits the impact of fire on vegetation distribution. Information about the land use fraction was only available for JSBACH-SPITFIRE and LPJ-GUESS-SIMFIRE-BLAZE. Using either the land use fraction of the individual model or the average, the fire-induced reduction in tree cover for the model ensemble varies between 15% and 16%. The complexity of the vegetation dynamics within the models appears to matter for the magnitude of the impact

of fire on tree cover. The LPJ-GUESS models estimate a lower impact (SIMFIRE-BLAZE: 3%, SPITFIRE: 6%) of fire on tree cover (Figure S4; Table S1) compared to JSBACH-SPITFIRE (9%) and JULES-INFERNNO (25%). The coefficient of variation of the tree cover changes is higher for the more complex LPJ-GUESS models and indicates that the impact of fire on tree cover in these models is less direct (Table S1). The LPJ-GUESS models include age cohorts, while JSBACH-SPITFIRE and JULES-INFERNNO represent vegetation in terms of a mean individual plant. However, a systematic comparison of different model formulations would be necessary to reliably answer the question how model complexity influences the results.

3.2 | Fire impacts on the carbon cycle

Fire generally reduces carbon storage, GPP and turnover times, that is, fire accelerates the carbon cycle, in the model simulations (Figure 4). The impact of fire is highest in the tropics (Figure 5) where annual burned area is highest and the simulated burned area compares well to observations (Figure S3). High relative

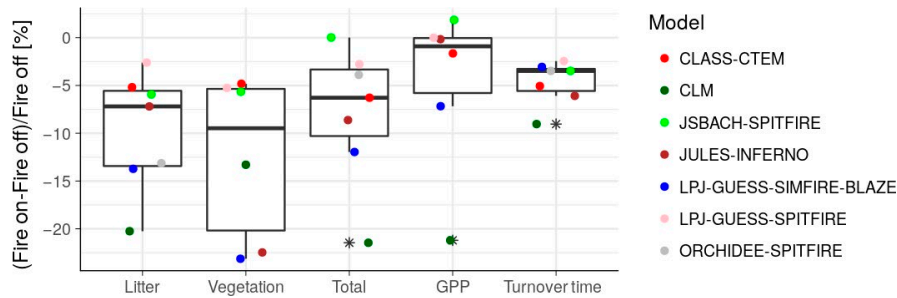

FIGURE 4 Relative changes in % of gross primary productivity (GPP), carbon pools and turnover time due to fire (placement of points along the x-axis is to avoid overplotting). Boxplots indicate median, interquartile range, maximum, minimum or outliers (asterisk) of the model ensemble. The effects on GPP and vegetation carbon are strongly limited in ORCHIDEE due to the use of prescribed tree heights; therefore, no data for ORCHIDEE are shown in these panels

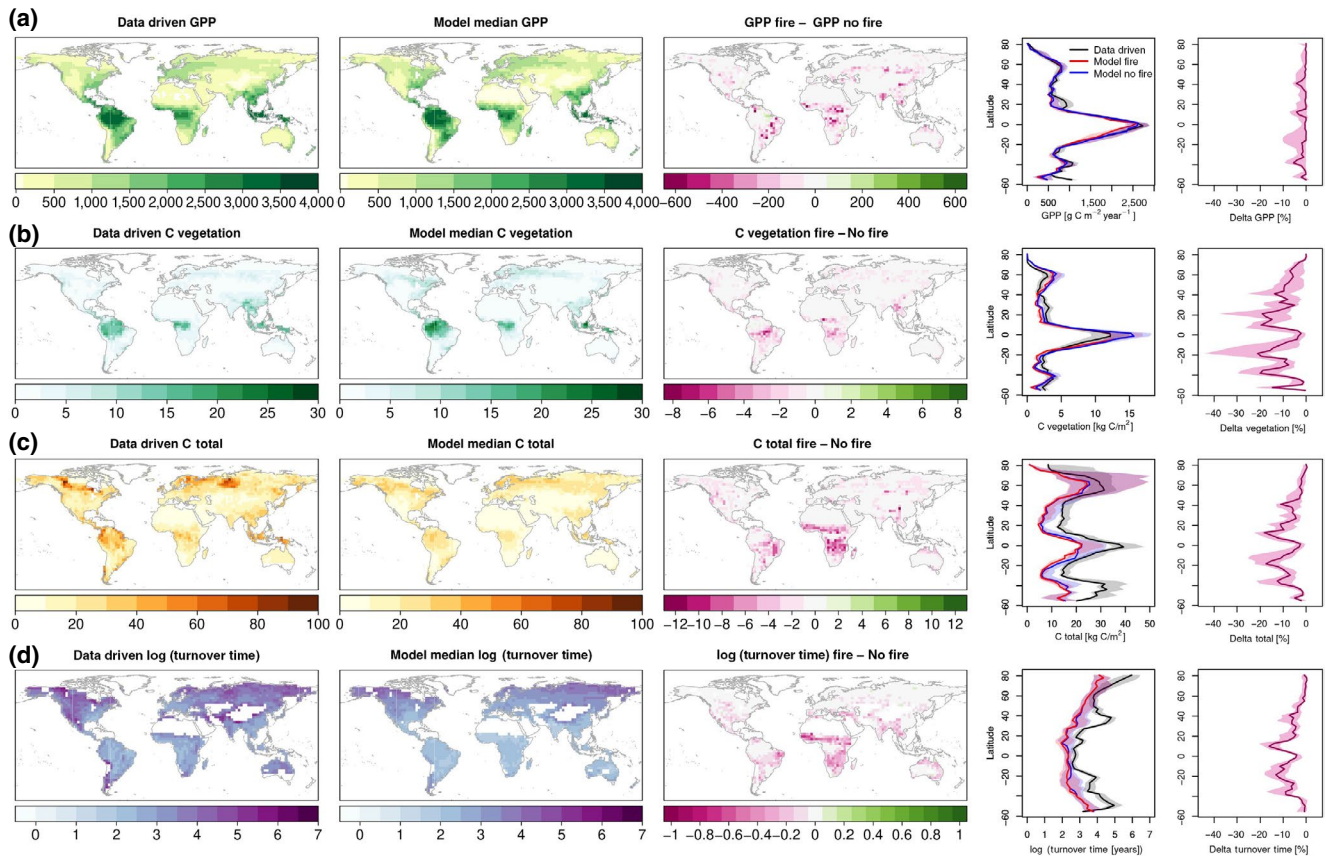

FIGURE 5 Spatial distribution and latitudinal gradients of gross primary productivity (GPP; a), vegetation carbon (b), total terrestrial carbon (c), turnover times (d), from observation driven estimates (first column), reference simulation including fire (second column) and difference between reference and no fire simulations (third column). The fourth column shows the latitudinal gradients of the data-driven estimate, the reference simulation and the simulation without fire. The last column shows the relative difference between the two simulations, for example, the impact of fire. Shaded areas indicate uncertainty in the datasets and the spread of the model ensemble (interquartile range)

impacts indicate that ecosystem structure is strongly impacted by fire, and may therefore be sensitive to changes in fire regimes. For carbon management strategies, which aim to maximize the terrestrial carbon storage, the absolute impacts are more important. Globally, the relative impact of fire is strongest on the directly affected carbon pools (vegetation and litter) and all models show a fire-induced reduction of these pools (Figure 4). The global

relative losses of vegetation carbon are higher than for the other carbon pools (Table 2). The relative impact in certain latitudinal bands is strong (up to around 20%, Figure 5, fifth column). The largest impacts are located around the edges of tropical rainforests (Figure 5), where there is more fire activity than in the heart of the rainforests and where vegetation productivity and tree cover are less limited by dry conditions. Savanna regions show a

Global	GPP (Pg C/ year or %)	C Vegetation (Pg C or %)	C Litter (Pg C or %)	C Total (Pg C or %)	Turnover time (years or %)
Median absolute	-1.07	-62.01	-10.10	-103.01	-0.93
75% percentile absolute	-0.07	-28.57	-5.67	-49.89	-0.49
25% percentile absolute	-7.53	-101.35	-27.64	-190.95	-1.46
Median relative (%)	-0.90	-9.48	-7.19	-6.29	-3.48
75% percentile relative (%)	-0.04	-5.36	-5.56	-3.33	-3.27
25% percentile relative (%)	-5.79	-20.18	-13.43	-10.29	-5.58
Savanna regions					
Median absolute	-0.39	-35.01	-2.32	-44.39	-1.1
75% percentile absolute	0.37	-16.22	-1.87	-25.46	-0.8
25% percentile absolute	-3.6	-57.19	-10.13	-83.85	-1.15
Median relative (%)	-0.82	-17.27	-7.7	-8.59	-10.26
75% percentile relative (%)	0.54	-7.83	-6.52	-7	-7.68
25% percentile relative (%)	-7.62	-30.72	-22.39	-16.8	-12.49

Abbreviation: GPP, gross primary productivity.

fire-induced reduction of 17% in vegetation carbon, globally this reduction is only 9.5% (Table 2). For the litter carbon, the difference between the global relative impact and savanna regions is small (7.2% and 7.7%, Table 2).

Models show a consistent decrease in total carbon (Figure 4) with a median reduction of 6% (first quartile is 3.3%, third quartile 10.3%, Table 2). The total median absolute loss is 100 Pg C with 44 Pg C in savanna regions. The amount of carbon lost from vegetation is the largest contribution to the total carbon loss (Table 2, 60% globally and 79% in savanna regions).

Only in the case of GPP does the model ensemble show a fire-induced increase in a few grid cells in South America (Figure 5a), but the sum over grid cells with increasing GPP is only 7% of the total GPP decreases. The median global response of GPP to fire is near zero (1%, first quartile: 0.03, third quartile: 5.8%, Table 2). Models not including dynamic biogeography (CLM, CLASS-CTEM) show a decrease in GPP due to fire (Figures 4 and 5a). The response of models including dynamic biogeography diverges. Two models show little change (LPJ-GUESS-SPITFIRE and JULES-INFERN0), one shows a clear fire-induced reduction (LPJ-GUESS-SIMFIRE-BLAZE) and one shows an increase in GPP (JSBACH-SPITFIRE). Including fire does

TABLE 2 Absolute and relative impacts on GPP, carbon pools and turnover times estimated by comparing simulations with and without fire for the globe and for savanna regions

not significantly change the mismatch between models and observation-driven datasets of GPP (Table 1).

The carbon turnover time decreases due to fire for all models (Figure 4). However, this fire-induced reduction in turnover is globally less than 10% for all models with a median reduction of turnover time of 3.5%, a small difference between the first (3.3%) and third (5.6%) quartiles. The model spread in carbon turnover time is from 2.5% to 9%, which is relatively small compared to total or vegetation carbon storage (Figure 4). The absolute global median decrease in turnover time is less than 1 year (Table 2). In savanna regions, the absolute impact of fire on turnover times is similar but the relative impact is stronger (between 7.7% and 12.5%),

The simulated global distribution and latitudinal gradient of GPP and carbon stored in vegetation agree well with observation-driven estimates (Figure 5a,b). The model spread for the latitudinal gradient is similar to the uncertainty of the observation-driven estimate (Figure 5). The improvement in NME when fire is included is significant for the model ensemble in the case of vegetation carbon and very small for GPP (Table 1). For the total carbon storage and turnover times, the model ensemble medians are clearly lower than the observation-driven estimates (Figure 5c,d).

The NME between models and the observation-driven dataset for total carbon storage shows a poor model performance and the NME increases when including fire for the model ensemble and most individual models (Table 1). The difference between simulated total carbon stored and the observation-driven dataset stem from lower simulated soil carbon storage, as the vegetation carbon is similar between models and data. The largest difference in the spatial patterns of turnover times is located in high altitude and high latitude regions where turnover times are much higher in the observation-driven dataset. For all simulations, the carbon cycle components of the model ensemble are always closer to the observation-driven datasets than any individual model (Table 1) which supports the use of model ensembles to reduce uncertainties in simulation results.

Models including a nitrogen cycle (CLM, LPJ-GUESS-SIMFIRE-BLAZE; Figure 2) show the strongest response in GPP, litter and total carbon storage and are two of the three models with strongest response for carbon stored in vegetation (Figure 4). There is no clear tendency of models including dynamic biogeography to

have stronger or weaker influences on the carbon cycle compared to models with prescribed biogeography (Figures 2 and 4).

The spatial patterns of fire-induced changes are similar for the different carbon cycle components (Figure 5) and they resemble the spatial patterns of simulated burned area (Figure S3). However, the spatial patterns of burned area and fire impacts on different carbon cycle components are not the same. The impacts peak at different climatic conditions in terms of precipitation and the highest impacts do not necessarily occur at maximum burning (Figure 6). The relative impact of fire on GPP peaks at precipitation values below 500 mm/year, the largest impact on vegetation carbon occurs at 700 mm/year. Tree cover, total carbon and turnover times have peak relative impacts of fire at higher precipitation values (900 mm/year), where burned area is also highest (Figure 6a). Highest absolute impacts occur under moister conditions compared to the regions with highest burning (Figure 6b). Absolute impacts of fire on vegetation carbon and GPP peak at high values of mean annual precipitation (1,500 mm/year) as carbon storage and productivity increase with moisture (Figure 6).

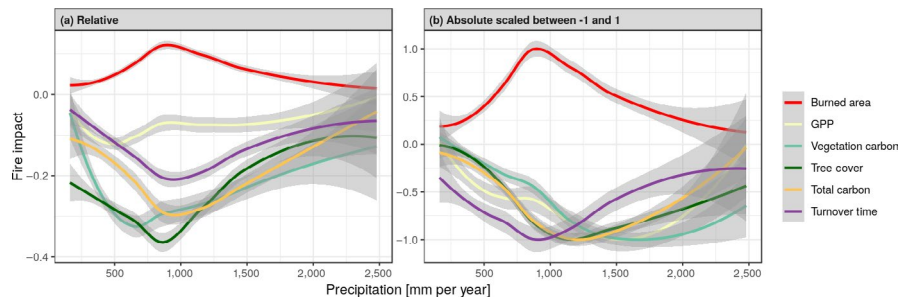

FIGURE 6 Local polynomial regression fit (loess) of the (a) relative and (b) normalized absolute impact of fire on gross primary productivity (GPP), vegetation carbon, tree cover, total carbon and turnover time versus mean annual precipitation for the model ensemble median. The dataset was filtered for data where burned fraction was higher than 0.01 on average and truncated for precipitation higher than 2,500 mm/year as under such high precipitation conditions no regular burning occurs. In (b), the regression lines were normalized such that the minimum or maximum of the regression is -1 for the impacts and 1 for burned area

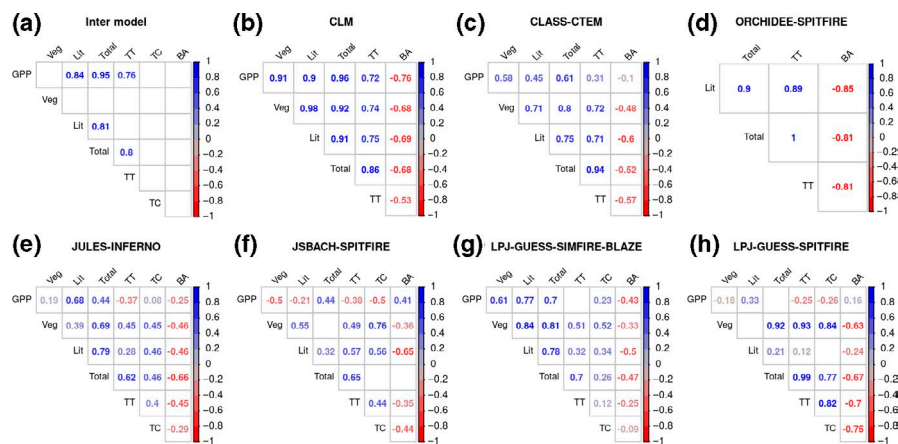

FIGURE 7 Inter- (a) and intra-model (b-h) Pearson correlation between changes in carbon cycle components and burned area. Inter-model correlation was calculated using the changes in mean values due to fire. Intra-model correlations are based on temporal averages of grid cell values. White fields indicate that the correlation was not significant. Tree cover (TC) in the inter-model panel only includes the four models with dynamic biogeography (models in second row). BA stands for burned area, TT for turnover time, Total for total carbon storage, Lit for carbon stored in litter, Veg for carbon stored in vegetation and GPP for gross primary productivity. The colour scale corresponds to correlation coefficients. CLM, Community Land Model

3.3 | Relationships between fire impacts

To understand the relationships between burned area and fire impacts on the different model components, we examine inter-model and intra-model correlations between changes in burned area, tree cover and the carbon cycle components (Figure 7). These correlations show that models with a strong effect of fire on vegetation productivity also show a strong influence of fire on litter and total carbon storage. The influence of fire on litter correlates with the influence on total carbon while changes in total carbon correlate with changes in turnover time. Correlations between any other two model variables are not significant. The inter-model correlations between burned area and fire impacts are not significant (Figure 7). Differences in global burned area between models therefore do not explain any differences in fire impacts. This indicates that the parameterization of the fire impact is more important than the extent of fire occurrence in the models. The intra-model correlations show that models with prescribed land cover show stronger correlations between changes in burned area and carbon cycle components (Figure 7; CLM, CLASS-CTEM and ORCHIDEE-SPITFIRE). For these models, the correlations between impacts on different carbon cycle components are positive and correlations between burned area and impacts on carbon cycle are negative. Correlations are weaker for models with dynamic biogeography or show both positive and negative relationships between carbon cycle components. This indicates that a higher degree of coupling between the modelled processes dampens the effects of fire in vegetation models.

4 | DISCUSSION

4.1 | Differences to previous studies and possible reasons

Models that include the effects of fire on biogeography consistently produce a fire-induced tree cover reduction, in this and in previously published studies. Our study indicates an apparent smaller impact of fires on vegetation type compared to previous studies, which found a doubling of forest area without fire using a fire-vegetation model (Bond et al., 2005) and a reduction in tree cover of between 15% and 25% with fire based on a vegetation model in combination with remote sensing burned area datasets (Poulter et al., 2015). The forest area in the first study was defined as the area of grid cells with tree cover greater than 80%. Comparing these two metrics of vegetation change, we find a 3.5 times higher fire-induced change for forest area than for tree cover (35% change in forest area and 10% change in tree covered area). Another important difference between the present study and previous studies is the representation of anthropogenic land use and land cover change, which is prescribed in the models here and was not taken into account in previous studies. Taking this into account leads to a reduction in tree cover in the models since anthropogenic land cover excludes woody functional types, and therefore decreases the potential tree cover without fire.

Both of the available studies did not take into account land use effects on tree cover. We estimate a 16% fire-induced reduction in tree cover without land use (Supporting Information S4) compared to a 10% reduction when land use is taken into account. This compares well to the lower estimate of Poulter et al. (2015), which was achieved using one of the most accurate burned area satellite datasets (Padilla et al., 2015). Assuming a ratio between changes in forest cover and tree cover of 3.5 as identified above yields an increase in forest cover of 56% when fire is excluded and land use not taken into account, an estimate much closer to the Bond et al. (2005) study.

A final reason for the reduced impact of fire on tree cover in the current study compared to previous studies is the representation of burned area in terms of global extent and spatial distribution. Land use not only influences the tree cover but also burned area. Although increases in fire occurrence due to humans are shown in local and regional studies (Bowman et al., 2011), on a global scale the dominant signal is a reduced burned area in response to land use (Andela et al., 2017; Bistinas, Harrison, Prentice, & Pereira, 2014). Landscape fragmentation and reduction of fuel loads are plausible explanations of these observed responses. Global burned area datasets and the FireMIP models which used these datasets to constrain the global burned area should therefore have lower total burned area than a fire model without human effects as used in Bond et al. (2005). Besides the global extent of burning the spatial distribution of burned area has consequences for the fire-induced changes in tree cover: the potential fire-induced tree-cover reduction in regions with low tree cover is smaller than in regions with high tree cover. While older fire models usually show very low spatial variability (Kloster & Lasslop, 2017), more recent models improved the sharp contrast between the low fire occurrence in closed forests and high burning in grasslands shown by observations (Hantson et al., 2020; Teckentrup et al., 2019). A lower impact of fire on tree cover in these recent models can therefore be expected.

4.2 | Confidence in simulated fire impacts

Based on the comparison of simulated patterns with observational datasets, the spread between models and our understanding of the processes based on previous studies, we have higher confidence in certain aspects of our results.

The models' ability to reproduce the spatial patterns of burned area is good, especially in the savanna regions, where we find the highest impacts (Figure S3). Although the spatial patterns are consistent across available burned area datasets, the global and regional totals of burned area are still subject to large uncertainties (Chuvienco et al., 2019). In combination with the large spread in global total impacts of fire between models (Figure 4), we have lower confidence in the global totals compared to the spatial patterns.

The improved agreement between observation-driven datasets and the model ensemble mean or median compared to individual models (Figure S3; Figure 3; Table 1) for any of the parameters we investigated identifies a higher confidence in the ensemble results

compared to results of individual models. This improved performance of ensembles is found in many fields, for instance, for climate models (Flato et al., 2013).

The models capture the spatial distribution of tree cover and vegetation carbon and including fire in the simulations leads to significant reductions in NME for these two parameters (Table 1). The improvements are smaller for the vegetation carbon, which may partly reflect the high uncertainty in biomass data products (Mitchard et al., 2013). The effect of fire on vegetation type is only included in four models, the sample size is therefore small, but remains a significant improvement over previous studies using individual models. The consistency between models, but also the consistency between modelled results, expectations based on previous model simulations (Bond et al., 2005; Poulter et al., 2015) and fire exclusion experiments (Furley et al., 2008) lead to a high confidence in the modelled results on the impact of fire on tree cover and vegetation carbon.

Carbon stored in litter pools is also consistently reduced due to fire, but the evaluation is difficult as definitions of litter pools differ between models, and the uncertainties associated with an available global dataset are unknown (Pettinari & Chuvieco, 2016). Nevertheless, the similar spread between models for the impacts on litter and vegetation carbon indicates a similar uncertainty for fire effects in litter as for vegetation carbon (Table 2; Figure 4).

There is less consistency between models about the impact of fire on productivity and total carbon storage (Figure 4). Including fire in the simulations does not decrease the differences between simulations and observation-driven datasets for productivity and carbon storage (Table 1). It is however also unclear how well the observation-driven datasets capture the effects of fire. Moreover, observational evidence on how fire affects productivity and soil carbon is low. Previous modelling studies on the impact of fire on productivity show a similar divergence in estimated fire-induced productivity changes (Li et al., 2014; Poulter et al., 2015; Yue et al., 2015). Increases in productivity due to changes in vegetation types and structure, for example, through the higher productivity of regenerating forests and of C_4 grasses compared to trees, was found previously in a study investigating effects of land use change using vegetation models (Krause et al., 2018). Literature reviews show that grasslands and pastures can have higher soil carbon content than forests (Guo & Gifford, 2002; Jackson, Banner, Jobbágy, Pockman, & Wall, 2002). Fire exclusion experiments suggest that fire increases soil carbon in needleleaf forests but substantially decreases soil carbon in savannas, grasslands and broadleaf forests (Pellegrini et al., 2017). Dedicated simulations that account for the site-specific conditions of fire exclusion experiments would be required to make better use of these datasets in model development.

4.3 | Limitations in current modelling approaches

Comparison with observation-driven datasets showed that the models poorly capture the patterns and magnitude of soil carbon storage.

Moreover, observations regarding the effects of fire on soil carbon are limited and the process is not well understood and represented in models (Lasslop, Coppola, Voulgarakis, Yue, & Veraverbeke, 2019). Emissions from peatland fires are only included in one model (CLM) diagnostically, for example, CLM diagnoses emissions but does not represent the carbon stocks of peatlands nor the effects of fire on them (Li, Levis, & Ward, 2013; Rabin et al., 2017). Smoke radiocarbon measurements show that peat burning releases carbon that has been locked away for several hundred years (Wiggins et al., 2018). Emissions from peatland fires are estimated to be a substantial proportion of the present-day global fire emissions (van der Werf et al., 2010). The lack of peat fire representation in models may lead to a substantial underestimation of net carbon loss from terrestrial carbon stocks due to fire.

A second important effect of fire is the production of charcoal during combustion. The high recalcitrance of charcoal allows the transport of this compound by rivers to the ocean where it can be preserved for thousands of years (Santín et al., 2016). Charcoal therefore reduces the effect of fire as carbon source to the atmosphere (Jones, Santín, van der Werf, & Doerr, 2019; Seiler & Crutzen, 1980). Estimates of pyrogenic carbon stocks in soil and ocean are higher than the losses in the terrestrial carbon storage simulated by vegetation models which indicates that fire could even be a net sink of carbon for the atmosphere (Lasslop et al., 2019). While this process may be less important on decadal to centennial time scales, it is important to assess the net effect of fire on the global carbon cycle on the long term.

Nutrient limitations are important to accurately model the carbon cycle (Wang et al., 2017; Wårlind, Smith, Hickler, & Arneeth, 2014) and only two of the models used in this study include a nitrogen cycle. The models calculate the losses of nitrogen and account for the redeposition by prescribing nitrogen deposition. The nitrogen fertilization due to redeposition can be of similar importance as the nutrient losses (Bauters et al., 2018; Chen et al., 2010). In our experiments, the models use the same nitrogen deposition input dataset for both simulations, which, by their construction, include nitrogen emitted by fires, transported through the atmosphere and then re-deposited. This means that the deposition datasets used as input in the simulation without fire still deposit nitrogen that originated from fire emissions. The simulations are therefore not consistent, which leads to an overestimation of fire effects in these models and may explain the stronger response of these two models (Figure 4). Nitrogen deposition fields without fire-derived nitrogen need to be developed to properly account for the effects of nitrogen in such experiments.

4.4 | Implications of the impacts of fire with changing fire regimes

Understanding the impact of fire on ecosystems is especially important as strong, regionally varying changes in fire regimes are observed over the last two decades (Andela et al., 2017; Forkel, Dorigo,

et al., 2019). We find that the influence of fire, estimated by comparing simulations with and without fire, is strongest in regions where large changes in burned area were observed (Andela et al., 2017; Forkel, Dorigo, et al., 2019), for example, tropical savannas, particularly in Africa (Figures 3 and 5).

We show that changes in fire regimes imply changes in tree cover and carbon storage. Tree cover is an important parameter for biodiversity (Tews et al., 2004) and ecosystem services, such as carbon storage (Grassi et al., 2017), and water provision (Evaristo & McDonnell, 2019). However, increased tree cover does not always imply increased biodiversity or ecosystem services: trees reduce streamflow in many regions of the world (Bentley & Coomes, 2020), and a recent study indicates that biodiversity is maximized when fire regimes are variable, not when fire is excluded (Beale et al., 2018). Tree cover is also an important driver for the global spatial distribution of the emergence of zoonotic infectious disease events, with hotspots located in Africa and higher tree cover increasing the risk of disease events (Allen et al., 2017). Moreover, fire directly impacts abundance of infectious disease pathogens in various regions of the world (Scasta, 2015). The strong observed decreases in burned area (Andela et al., 2017) in regions with highest fire impacts, for example, northern hemisphere Africa (Figures 3 and 5), the potential direct and indirect (through tree cover) effects of fire on biodiversity and disease risks, imply that an increased monitoring of fire regime changes, ecosystem structure, biodiversity and disease pathogens in this region could potentially improve the understanding of this interdisciplinary net of processes.

5 | CONCLUSIONS

We present the first multi-model assessment of the impact of fire on vegetation distribution and the carbon cycle with state-of-the-art fire-vegetation models, which take into account effects of anthropogenic land use change. The model ensemble mean or median performs better than any individual model according to comparisons with observations. We therefore consider our results to be the current best estimate of the global impact of fire on ecosystems. We provide a confidence ranking based on the inter-model differences and comparisons to observation-driven datasets of tree cover and carbon cycle components. The observational basis for model evaluation is good in terms of the spatial distribution of burned area and carbon cycle components, information on fire impacts is not available on global scale. However, process understanding and information from fire exclusion experiments support the simulated fire-induced reduction of tree covered areas and vegetation carbon storage of terrestrial ecosystems. Understanding of fire impacts on productivity and soil carbon is low. Missing soil carbon processes in models, such as permafrost and peatland processes, additionally limit the confidence in simulated results and model developments are required to advance. More detailed model-data synthesis studies and corroboration with site-level experiments are promising pathways to

further improve the understanding of fire-induced changes in fire-ecosystem interactions. Overall, our study confirms the globally significant role of fire in shaping ecosystem structure and the need to represent the process in dynamic vegetation models. In the context of efforts to mitigate and adapt to climate change and of the strong observed changes in fire regimes over the last decades, our results imply that fire and its future changes must be taken into account to understand the future trajectories of terrestrial ecosystem carbon storage and structure with knock-on effects on ecosystem services and biodiversity.

ACKNOWLEDGEMENTS

This study was part of the global Fire Model Intercomparison Project (FireMIP). G.L. was funded by the Deutsche Forschungsgemeinschaft (DFG, German Research Foundation) 338130981. SiS was funded by the Deutsche Forschungsgemeinschaft (DFG, German Research Foundation)—SCHE 1719/2-1. F.L. was funded by the National Natural Science Foundation of China (41475099 and 41875137). S.P.H. acknowledge support from the ERC-project GC2.0 (Global Change 2.0: Unlocking the past for a clearer future grant no. 694481). A.A. and S.H. acknowledge funding from the Helmholtz Association. C.B. was supported by the Newton Fund through the Met Office Climate Science for Service Partnership Brazil (CSSP Brazil). G.L. would like to thank Christopher Heislitz for the downloading and processing of satellite data. We thank the anonymous reviewer for helpful comments.

AUTHOR CONTRIBUTION

G.L. and S.H. designed the study and performed the analysis including suggestions from all authors. G.L. wrote the manuscript with contributions from all authors. G.L., S.H., M.F., F.L., C.Y., C.B. and J.M. contributed simulations. A.A., S.P.H., S.S. and S.H. defined the simulation protocol.

DATA AVAILABILITY STATEMENT

The displayed data and scripts are available upon request to the first author.

ORCID

Gitta Lasslop  <https://orcid.org/0000-0001-9939-1459>
 Stijn Hantson  <https://orcid.org/0000-0003-4607-9204>
 Matthias Forkel  <https://orcid.org/0000-0003-0363-9697>
 Joe R. Melton  <https://orcid.org/0000-0002-9414-064X>
 Simon Scheiter  <https://orcid.org/0000-0002-5449-841X>

REFERENCES

- Allen, T., Murray, K. A., Zambrana-Torrel, C., Morse, S. S., Rondinini, C., Di Marco, M., ... Daszak, P. (2017). Global hotspots and correlates of emerging zoonotic diseases. *Nature Communications*, 8(1), 1124. <https://doi.org/10.1038/s41467-017-00923-8>
- Andela, N., Morton, D. C., Giglio, L., Chen, Y., van der Werf, G. R., Kasibhatla, P. S., ... Randerson, J. T. (2017). A human-driven decline in global burned area. *Science*, 356(6345), 1356–1362. <https://doi.org/10.1126/science.aal4108>

- Bastin, J.-F., Finegold, Y., Garcia, C., Mollicone, D., Rezende, M., Routh, D., ... Crowther, T. W. (2019). The global tree restoration potential. *Science*, 365(6448), 76–79. <https://doi.org/10.1126/science.aax0848>
- Bauters, M., Drake, T. W., Verbeeck, H., Bodé, S., Hervé-Fernández, P., Zito, P., ... Boeckx, P. (2018). High fire-derived nitrogen deposition on central African forests. *Proceedings of the National Academy of Sciences of the United States of America*, 115(3), 549–554. <https://doi.org/10.1073/pnas.1714597115>
- Beale, C. M., Courtney Mustaphi, C. J., Morrison, T. A., Archibald, S., Anderson, T. M., Dobson, A. P., ... Parr, C. L. (2018). Pyrodiversity interacts with rainfall to increase bird and mammal richness in African savannas. *Ecology Letters*, 21(4), 557–567. <https://doi.org/10.1111/e.12921>
- Bentley, L., & Coomes, D. A. (2020). Partial river flow recovery with forest age is rare in the decades following establishment. *Global Change Biology*, 26(3), 1458–1473. <https://doi.org/10.1111/gcb.14954>
- Bistinas, I., Harrison, S. P., Prentice, I. C., & Pereira, J. M. C. (2014). Causal relationships versus emergent patterns in the global controls of fire frequency. *Biogeosciences*, 11, 5087–5101. <https://doi.org/10.5194/bg-11-5087-2014>
- Bond, W. J., Woodward, F. I., & Midgley, G. F. (2005). The global distribution of ecosystems in a world without fire. *The New Phytologist*, 165(2), 525–537. <https://doi.org/10.1111/j.1469-8137.2004.01252.x>
- Bond-Lamberty, B., Peckham, S. D., Ahl, D. E., & Gower, S. T. (2007). Fire as the dominant driver of central Canadian boreal forest carbon balance. *Nature*, 450(7166), 89–92. <https://doi.org/10.1038/nature06272>
- Bowman, D. M. J. S., Balch, J., Artaxo, P., Bond, W. J., Cochrane, M. A., D'Antonio, C. M., ... Swetnam, T. W. (2011). The human dimension of fire regimes on Earth. *Journal of Biogeography*, 38(12), 2223–2236. <https://doi.org/10.1111/j.1365-2699.2011.02595.x>
- Brancalion, P. H. S., Niamir, A., Broadbent, E., Crouzeilles, R., Barros, F. S. M., Almeyda Zambrano, A. M., ... Chazdon, R. L. (2019). Global restoration opportunities in tropical rainforest landscapes. *Science Advances*, 5(7), eaav3223. <https://doi.org/10.1126/sciadv.aav3223>
- Burton, C., Betts, R., Cardoso, M., Feldpausch, T. R., Harper, A., Jones, C. D., ... Wiltshire, A. (2019). Representation of fire, land-use change and vegetation dynamics in the Joint UK Land Environment Simulator vn4.9 (JULES). *Geoscientific Model Development*, 12(1), 179–193. <https://doi.org/10.5194/gmd-12-179-2019>
- Canadell, J. G., & Raupach, M. R. (2008). Managing forests for climate change mitigation. *Science*, 320(5882), 1456–1457. <https://doi.org/10.1126/science.1155458>
- Carvalho, N., Forkel, M., Khomik, M., Bellarby, J., Jung, M., Migliavacca, M., ... Reichstein, M. (2014). Global covariation of carbon turnover times with climate in terrestrial ecosystems. *Nature*, 514(7521), 213–217. <https://doi.org/10.1038/nature13731>
- Chen, Y., Randerson, J. T., Van Der Werf, G. R., Morton, D. C., Mu, M., & Kasibhatla, P. S. (2010). Nitrogen deposition in tropical forests from savanna and deforestation fires. *Global Change Biology*, 16(7), 2024–2038. <https://doi.org/10.1111/j.1365-2486.2009.02156.x>
- Chuvieco, E., Lizundia-Loiola, J., Pettinari, M. L., Ramo, R., Padilla, M., Tansey, K., ... Plummer, S. (2018). Generation and analysis of a new global burned area product based on MODIS 250 m reflectance bands and thermal anomalies. *Earth System Science Data*, 10(4), 2015–2031. <https://doi.org/10.5194/essd-10-2015-2018>
- Chuvieco, E., Mouillot, F., van der Werf, G. R., San Miguel, J., Tanase, M., Koutsias, N., ... Giglio, L. (2019). Historical background and current developments for mapping burned area from satellite Earth observation. *Remote Sensing of Environment*, 225, 45–64. <https://doi.org/10.1016/j.rse.2019.02.013>
- Devine, A. P., Stott, I., McDonald, R. A., & Maclean, I. M. D. (2015). Woody cover in wet and dry African savannas after six decades of experimental fires. *Journal of Ecology*, 103(2), 473–478. <https://doi.org/10.1111/1365-2745.12367>
- Evaristo, J., & McDonnell, J. J. (2019). Global analysis of streamflow response to forest management. *Nature*, 570(7762), 455–461. <https://doi.org/10.1038/s41586-019-1306-0>
- Flato, G., Marotzke, J., Abiodun, B., Braconnot, P., Chou, S. C., Collins, W., ... Rummukainen, M. (2013). Evaluation of climate models. In Intergovernmental Panel on Climate Change (Ed.), *Climate Change 2013 – The physical science basis* (pp. 741–866). Cambridge University Press. <https://doi.org/10.1017/CBO9781107415324.020>
- Forkel, M., Andela, N., Harrison, S. P., Lasslop, G., van Marle, M., Chuvieco, E., ... Arneeth, A. (2019). Emergent relationships with respect to burned area in global satellite observations and fire-enabled vegetation models. *Biogeosciences*, 16(1), 57–76. <https://doi.org/10.5194/bg-16-57-2019>
- Forkel, M., Dorigo, W., Lasslop, G., Chuvieco, E., Hantson, S., Heil, A., ... Harrison, S. P. (2019). Recent global and regional trends in burned area and their compensating environmental controls. *Environmental Research Communications*, 1(5), 051005. <https://doi.org/10.1088/2515-7620/ab25d2>
- Furley, P. A., Rees, R. M., Ryan, C. M., & Saiz, G. (2008). Savanna burning and the assessment of long-term fire experiments with particular reference to Zimbabwe. *Progress in Physical Geography: Earth and Environment*, 32(6), 611–634. <https://doi.org/10.1177/0309133308101383>
- Giglio, L., Randerson, J. T., & van der Werf, G. R. (2013). Analysis of daily, monthly, and annual burned area using the fourth-generation global fire emissions database (GFED4). *Journal of Geophysical Research: Biogeosciences*, 118(1), 317–328. <https://doi.org/10.1002/jgrg.20042>
- Grassi, G., House, J., Dentener, F., Federici, S., den Elzen, M., & Penman, J. (2017). The key role of forests in meeting climate targets requires science for credible mitigation. *Nature Climate Change*, 7(3), 220–226. <https://doi.org/10.1038/nclimate3227>
- Guo, L. B., & Gifford, R. M. (2002). Soil carbon stocks and land use change: A meta analysis. *Global Change Biology*, 8(4), 345–360. <https://doi.org/10.1046/j.1354-1013.2002.00486.x>
- Hansen, M. C., DeFries, R. S., Townshend, J. R. G., Carroll, M., Dimiceli, C., & Sohlberg, R. A. (2003). Global percent tree cover at a spatial resolution of 500 meters: First results of the MODIS vegetation continuous fields algorithm. *Earth Interactions*, 7(10), 1–15. [https://doi.org/10.1175/1087-3562\(2003\)007<0001:GPTCAA>2.0.CO;2](https://doi.org/10.1175/1087-3562(2003)007<0001:GPTCAA>2.0.CO;2)
- Hantson, S., Arneeth, A., Harrison, S. P., Kelley, D. I., Prentice, I. C., Rabin, S. S., ... Yue, C. (2016). The status and challenge of global fire modelling. *Biogeosciences*, 13(11), 3359–3375. <https://doi.org/10.5194/bg-13-3359-2016>
- Hantson, S., Kelley, D. I., Arneeth, A., Harrison, S. P., Archibald, S., Bachelet, D., ... Yue, C. (2020). Quantitative assessment of fire and vegetation properties in historical simulations with fire-enabled vegetation models from the Fire Model Intercomparison Project. *Geoscientific Model Development Discussions*, 2020, 1–25. <https://doi.org/10.5194/gmd-2019-261>
- Harden, J. W., Mack, M., Veldhuis, H., & Gower, S. T. (2002). Fire dynamics and implications for nitrogen cycling in boreal forests. *Journal of Geophysical Research*, 108(D3), 8223. <https://doi.org/10.1029/2001JD000494>
- He, T., Lamont, B. B., & Pausas, J. G. (2019). Fire as a key driver of Earth's biodiversity. *Biological Reviews*, 94(6), 1983–2010. <https://doi.org/10.1111/brv.12544>
- Higgins, S. I., Bond, W. J., February, E. C., Bronn, A., Euston-Brown, D. I. W., Enslin, B., ... Trollope, W. S. W. (2007). Effects of four decades of fire manipulation on woody vegetation structure in savanna. *Ecology*, 88(5), 1119–1125. <https://doi.org/10.1890/06-1664>
- Hirota, M., Holmgren, M., Van Nes, E. H., & Scheffer, M. (2011). Global resilience of tropical forest and savanna to critical transitions. *Science*, 334(6053), 232–235. <https://doi.org/10.1126/science.1210657>
- Jackson, R. B., Banner, J. L., Jobbágy, E. G., Pockman, W. T., & Wall, D. H. (2002). Ecosystem carbon loss with woody plant invasion of grasslands. *Nature*, 418(6898), 623–626. <https://doi.org/10.1038/nature00910>

- Jones, M. W., Santín, C., van der Werf, G. R., & Doerr, S. H. (2019). Global fire emissions buffered by the production of pyrogenic carbon. *Nature Geoscience*, 12(9), 742–747. <https://doi.org/10.1038/s41561-019-0403-x>
- Jung, M., Reichstein, M., Margolis, H. A., Cescatti, A., Richardson, A. D., Arain, M. A., ... Williams, C. (2011). Global patterns of land-atmosphere fluxes of carbon dioxide, latent heat, and sensible heat derived from eddy covariance, satellite, and meteorological observations. *Journal of Geophysical Research*, 116(3), G00J07. <https://doi.org/10.1029/2010JG001566>
- Kelley, D. I., Prentice, I. C., Harrison, S. P., Wang, H., Simard, M., Fisher, J. B., & Willis, K. O. (2013). A comprehensive benchmarking system for evaluating global vegetation models. *Biogeosciences*, 10(5), 3313–3340. <https://doi.org/10.5194/bg-10-3313-2013>
- Kloster, S., & Lasslop, G. (2017). Historical and future fire occurrence (1850 to 2100) simulated in CMIP5 Earth System Models. *Global and Planetary Change*, 150, 58–69. <https://doi.org/10.1016/j.gloplacha.2016.12.017>
- Krause, A., Pugh, T. A. M., Bayer, A. D., Li, W., Leung, F., Bondeau, A., ... Arneith, A. (2018). Large uncertainty in carbon uptake potential of land-based climate-change mitigation efforts. *Global Change Biology*, 24(7), 3025–3038. <https://doi.org/10.1111/gcb.14144>
- Lasslop, G., Brovkin, V., Reick, C. H., Bathiany, S., & Kloster, S. (2016). Multiple stable states of tree cover in a global land surface model due to a fire-vegetation feedback. *Geophysical Research Letters*, 43(12), 6324–6331. <https://doi.org/10.1002/2016GL069365>
- Lasslop, G., Coppola, A. I., Voulgarakis, A., Yue, C., & Veraverbeke, S. (2019). Influence of fire on the carbon cycle and climate. *Current Climate Change Reports*, 5(2), 112–123. <https://doi.org/10.1007/s40641-019-00128-9>
- Li, F., Bond-Lamberty, B., & Levis, S. (2014). Quantifying the role of fire in the Earth system – Part 2: Impact on the net carbon balance of global terrestrial ecosystems for the 20th century. *Biogeosciences*, 11(5), 1345–1360. <https://doi.org/10.5194/bg-11-1345-2014>
- Li, F., Levis, S., & Ward, D. S. (2013). Quantifying the role of fire in the Earth system – Part 1: Improved global fire modeling in the Community Earth System Model (CESM1). *Biogeosciences*, 10(4), 2293–2314. <https://doi.org/10.5194/bg-10-2293-2013>
- Liu, Z., Ballantyne, A. P., & Cooper, L. A. (2019). Biophysical feedback of global forest fires on surface temperature. *Nature Communications*, 10(1), 214. <https://doi.org/10.1038/s41467-018-08237-z>
- Mitchard, E. T., Saatchi, S. S., Baccini, A., Asner, G. P., Goetz, S. J., Harris, N. L., & Brown, S. (2013). Uncertainty in the spatial distribution of tropical forest biomass: A comparison of pan-tropical maps. *Carbon Balance and Management*, 8(1), 10. <https://doi.org/10.1186/1750-0680-8-10>
- Padilla, M., Stehman, S. V., Ramo, R., Corti, D., Hantson, S., Oliva, P., ... Chuvieco, E. (2015). Comparing the accuracies of remote sensing global burned area products using stratified random sampling and estimation. *Remote Sensing of Environment*, 160, 114–121. <https://doi.org/10.1016/j.rse.2015.01.005>
- Pellegrini, A. F. A., Ahlström, A., Hobbie, S. E., Reich, P. B., Nieradzik, L. P., Staver, A. C., ... Jackson, R. B. (2017). Fire frequency drives decadal changes in soil carbon and nitrogen and ecosystem productivity. *Nature*, 553(7687), 194–198. <https://doi.org/10.1038/nature24668>
- Pettinari, M. L., & Chuvieco, E. (2016). Generation of a global fuel data set using the Fuel Characteristic Classification System. *Biogeosciences*, 13(7), 2061–2076. <https://doi.org/10.5194/bg-13-2061-2016>
- Poulter, B., Cadule, P., Cheiney, A., Ciais, P., Hodson, E., Peylin, P., ... Zimmermann, N. E. (2015). Sensitivity of global terrestrial carbon cycle dynamics to variability in satellite-observed burned area. *Global Biogeochemical Cycles*, 29(2), 207–222. <https://doi.org/10.1002/2013GB004655>
- R Core Team. (2018). *R: A language and environment for statistical computing*. R Foundation for Statistical Computing. Retrieved from <http://www.r-project.org/>
- Rabin, S. S., Melton, J. R., Lasslop, G., Bachelet, D., Forrest, M., Hantson, S., ... Arneith, A. (2017). The Fire Modeling Intercomparison Project (FireMIP), phase 1: Experimental and analytical protocols with detailed model descriptions. *Geoscientific Model Development*, 10(3), 1175–1197. <https://doi.org/10.5194/gmd-10-1175-2017>
- Randerson, J. T., Chen, Y., van der Werf, G. R., Rogers, B. M., & Morton, D. C. (2012). Global burned area and biomass burning emissions from small fires. *Journal of Geophysical Research: Biogeosciences*, 117, G04012. <https://doi.org/10.1029/2012JG002128>
- Saatchi, S. S., Harris, N. L., Brown, S., Lefsky, M., Mitchard, E. T. A., Salas, W., ... Morel, A. (2011). Benchmark map of forest carbon stocks in tropical regions across three continents. *Proceedings of the National Academy of Sciences of the United States of America*, 108(24), 9899–9904. <https://doi.org/10.1073/pnas.1019576108>
- Sankaran, M., Hanan, N. P., Scholes, R. J., Ratnam, J., Augustine, D. J., Cade, B. S., ... Zambatis, N. (2005). Determinants of woody cover in African savannas. *Nature*, 438, 846–849. <https://doi.org/10.1038/nature04070>
- Santín, C., Doerr, S. H., Kane, E. S., Masiello, C. A., Ohlson, M., de la Rosa, J. M., ... Dittmar, T. (2016). Towards a global assessment of pyrogenic carbon from vegetation fires. *Global Change Biology*, 22(1), 76–91. <https://doi.org/10.1111/gcb.12985>
- Scasta, J. D. (2015). Fire and parasites: An under-recognized form of anthropogenic land use change and mechanism of disease exposure. *EcoHealth*, 12(3), 398–403. <https://doi.org/10.1007/s10393-015-1024-5>
- Scott, A. C., & Glasspool, I. J. (2006). The diversification of Paleozoic fire systems and fluctuations in atmospheric oxygen concentration. *Proceedings of the National Academy of Sciences of the United States of America*, 103(29), 10861–10865. <https://doi.org/10.1073/pnas.0604090103>
- Seiler, W., & Crutzen, P. J. (1980). Estimates of gross and net fluxes of carbon between the biosphere and the atmosphere from biomass burning. *Climatic Change*, 2(3), 207–247. <https://doi.org/10.1007/BF00137988>
- Staal, A., van Nes, E. H., Hantson, S., Holmgren, M., Dekker, S. C., Pueyo, S., ... Scheffer, M. (2018). Resilience of tropical tree cover: The roles of climate, fire, and herbivory. *Global Change Biology*, 24(11), 5096–5109. <https://doi.org/10.1111/gcb.14408>
- Staver, A. C., Archibald, S., & Levin, S. A. (2011). The global extent and determinants of savanna and forest as alternative biome states. *Science*, 334(6053), 230–232. <https://doi.org/10.1126/science.1210465>
- Teckentrup, L., Harrison, S. P., Hantson, S., Heil, A., Melton, J. R., Forrest, M., ... Lasslop, G. (2019). Response of simulated burned area to historical changes in environmental and anthropogenic factors: A comparison of seven fire models. *Biogeosciences*, 16(19), 3883–3910. <https://doi.org/10.5194/bg-16-3883-2019>
- Tews, J., Brose, U., Grimm, V., Tielbörger, K., Wichmann, M. C., Schwager, M., & Jeltsch, F. (2004). Animal species diversity driven by habitat heterogeneity/diversity: The importance of keystone structures. *Journal of Biogeography*, 31(1), 79–92. <https://doi.org/10.1046/j.0305-0270.2003.00994.x>
- Thonicke, K., Venevsky, S., Sitch, S., & Cramer, W. (2001). The role of fire disturbance for global vegetation dynamics: Coupling fire into a Dynamic Global Vegetation Model. *Global Ecology and Biogeography*, 10(6), 661–677. <https://doi.org/10.1046/j.1466-822X.2001.00175.x>
- Townsend, J. R. G., Carroll, M., DiMiceli, C., Sohlberg, R., Hansen, M., & DeFries, R. (2011). *Vegetation continuous fields MOD44B, 2001–2010 percent tree cover, collection 5, version 051*. College Park, MD: University of Maryland.
- van der Werf, G. R., Randerson, J. T., Giglio, L., Collatz, G. J., Mu, M., Kasibhatla, P. S., ... van Leeuwen, T. T. (2010). Global fire emissions and the contribution of deforestation, savanna, forest, agricultural, and peat fires (1997–2009). *Atmospheric Chemistry and Physics*, 10(23), 11707–11735. <https://doi.org/10.5194/acp-10-11707-2010>

- Wang, R., Goll, D., Balkanski, Y., Hauglustaine, D., Boucher, O., Ciais, P., ... Tao, S. (2017). Global forest carbon uptake due to nitrogen and phosphorus deposition from 1850 to 2100. *Global Change Biology*, 23(11), 4854–4872. <https://doi.org/10.1111/gcb.13766>
- Wärilind, D., Smith, B., Hickler, T., & Arneeth, A. (2014). Nitrogen feedbacks increase future terrestrial ecosystem carbon uptake in an individual-based dynamic vegetation model. *Biogeosciences*, 11(21), 6131–6146. <https://doi.org/10.5194/bg-11-6131-2014>
- Wiggins, E. B., Czimczik, C. I., Santos, G. M., Chen, Y., Xu, X., Holden, S. R., ... Yu, L. E. (2018). Smoke radiocarbon measurements from Indonesian fires provide evidence for burning of millennia-aged peat. *Proceedings of the National Academy of Sciences of the United States of America*, 115(49), 12419–12424. <https://doi.org/10.1073/pnas.1806003115>
- Wirth, C. (2005). Fire regime and tree diversity in boreal forests: Implications for the carbon cycle. In M. Scherer-Lorenzen, C. Körner, & E. D. Schulze (Eds.), *Forest diversity and function. Ecological studies (analysis and synthesis)* (pp. 309–344). Springer-Verlag. https://doi.org/10.1007/3-540-26599-6_15
- Yue, C., Ciais, P., Cadule, P., Thonicke, K., & van Leeuwen, T. T. (2015). Modelling the role of fires in the terrestrial carbon balance by incorporating SPITFIRE into the global vegetation model ORCHIDEE – Part 2: Carbon emissions and the role of fires in the global carbon balance. *Geoscientific Model Development*, 8(5), 1321–1338. <https://doi.org/10.5194/gmd-8-1321-2015>
- Yue, C., Ciais, P., Zhu, D., Wang, T., Peng, S. S., & Piao, S. L. (2016). How have past fire disturbances contributed to the current carbon balance of boreal ecosystems? *Biogeosciences*, 13(3), 675–690. <https://doi.org/10.5194/bg-13-675-2016>

SUPPORTING INFORMATION

Additional supporting information may be found online in the Supporting Information section.

How to cite this article: Lasslop G, Hantson S, Harrison SP, et al. Global ecosystems and fire: Multi-model assessment of fire-induced tree-cover and carbon storage reduction. *Glob Change Biol*. 2020;26:5027–5041. <https://doi.org/10.1111/gcb.15160>