



**Research article**

urn:lsid:zoobank.org:pub:F062C142-9DA5-464B-92F7-B05FCF4590F9

**Comparative and cladistic analyses of the species of the genus  
*Pelodera* Schneider, 1866 (Rhabditidae: Nematoda)  
belonging to the *coarctata* group**

Mohammad MAHBOOB <sup>1</sup>, Rehmat JAHAN<sup>2</sup> & Qudsia TAHSEEN <sup>3,\*</sup>

<sup>1,2,3</sup>Nematode Research Laboratory, Department of Zoology, Aligarh Muslim University,  
Aligarh-202002, India.

\*Corresponding author: [qtahseen@gmail.com](mailto:qtahseen@gmail.com)

<sup>1</sup>Email: [mohdmahboob05@gmail.com](mailto:mohdmahboob05@gmail.com)

<sup>2</sup>Email: [rehmatjahan786@gmail.com](mailto:rehmatjahan786@gmail.com)

<sup>1</sup>urn:lsid:zoobank.org:author:2AC2EB4A-7235-4322-8297-B090AE9F3BF0

<sup>2</sup>urn:lsid:zoobank.org:author:2478B909-293A-48A3-B56E-F8A0D0256591

<sup>3</sup>urn:lsid:zoobank.org:author:CA060608-7296-45B6-BDC6-4BA557043268

**Abstract.** Three new species of the genus *Pelodera* Schneider, 1866 viz., *P. indica* sp. nov., *P. adeeli* sp. nov. and *P. paratretzeli* sp. nov. collected from dung beetles and *P. cylindrica* (Cobb, 1898) collected from soil samples, are described and illustrated. *Pelodera indica* sp. nov. is characterised by sexual dimorphism in anterior region, cupola-shaped tail with a spike; males having punctated, striated and lobed bursa with no genital papillae originating anterior to cloaca. *Pelodera adeeli* sp. nov. is characterised by coarsely annulated cuticle; relatively narrow stoma; tail conoid without spike; males with punctated, lobed bursa and nine pairs of genital papillae arranged in a 2/1+2+P+3+1 configuration. *Pelodera paratretzeli* sp. nov. is characterised by sexual dimorphism in anterior region, stoma wide with three well-developed metastegostomal denticles; tail cupola-shaped with a long spike; males having spicules fused distally up to 12–14% of spicule length; bursa peloderan, anteriorly closed and punctated with nine pairs of genital papillae arranged in a 3/2+P+3+1 configuration. *Pelodera cylindrica* is described with additional details. The comparative analysis as well as phylogenetic relationship of the species belonging to the *coarctata* group have been elaborated by incorporating scanning electron microscopic observations. Information on the biogeographical distribution has also been provided.

**Keywords.** Description, insect-associated nematodes, morphology, *Pelodera indica* sp. nov., *P. adeeli* sp. nov., *P. paratretzeli* sp. nov., *P. cylindrica*, SEM, taxonomy.

Mahboob M., Jahan R. & Tahseen Q. 2023. Comparative and cladistic analyses of the species of the genus *Pelodera* Schneider, 1866 (Rhabditidae: Nematoda) belonging to the *coarctata* group. *European Journal of Taxonomy* 890: 71–114. <https://doi.org/10.5852/ejt.2023.890.2253>

## Introduction

The genus *Pelodera* was proposed by Schneider in 1866 mainly based on its peloderan bursa in contrast to the genus *Leptodera* Dujardin, 1845, which was raised for the species with a leptoderan

bursa. Out of four new species, *Pelodera strongyloides* (Schneider, 1860), *P. teres*, *P. papillosa* and *P. pelli*, *P. strongyloides* was designated as type species based on its conspicuous lip region; three setose metastegostomal denticles; female tail cupola-shaped; spicules fused at the distal end and bursa anteriorly closed.

Osche (1952) considered *Rhabditis* Dujardin, 1844 as a genus representing the subgenera *Rhabditis*, *Choriorhabditis*, *Teratorhabditis*, *Caenorhabditis*, *Mesorhabditis*, *Telorhabditis*, and *Protorhabditis*. Furthermore, he categorised the subgenus *Rhabditis* into four groups viz., *teres*, *lambdiensis*, *coarctata* and *cylindrica*. Dougherty (1953) did not agree with Osche's scheme and considered *Pelodera*, *Cruznama* Artigas, 1927, *Coarctodera* Dougherty, 1953 and *Cylindrodera* Dougherty, 1953 as full-fledged genera. However, Andr ssy (1984), by following Dougherty's (1953) scheme, considered *Pelodera* as a genus. Afterwards, Sudhaus & Fitch (2001), while working on the phylogeny and systematics of the family Rhabditidae, considered *Pelodera* as a subgenus of *Rhabditis* and categorised it into two major species groups viz., the *coarctata* and *teres* groups. The *teres* group was further divided into *teres* and *strongyloides* subgroups based on the presence or absence of a pharyngeal sleeve, the number of precloacal papillae and the extent of fusion of the spicules.

Later, Sudhaus (2011) published a catalogue on the family Rhabditidae and reinstated *Pelodera* as a genus. He synonymised *Coarctodera* and *Cylindrodera* with *Pelodera* and provided a list of 24 valid species placed under the species groups (*coarctata*, *strongyloides* and *teres* groups).

The present paper provides the description based on light and scanning electron microscopic studies of three new entomophilic species, *Pelodera indica* sp. nov., *P. adeeli* sp. nov. and *P. paratretzeli* sp. nov. isolated from dung beetles and a known species, *P. cylindrica* (Cobb, 1898), extracted from the soil. A morphology-based cladistic analysis of the genus *Pelodera* (*coarctata*-group) was performed to resolve the exact status of the species and their relationships.

## Material and methods

### Collection and isolation/extraction of nematodes

During a survey of insect-associated nematodes, the dung beetles, *Catharsius molossus* (Linnaeus, 1758) and *Onthophagus ramosus* (Wiedemann, 1823) were collected from the Terai region (Sidharthnagar and Gonda districts of Eastern Uttar Pradesh), while *Digitonthophagus bonasus* (Fabricius, 1775) was collected from the district Aligarh. The collected insects were brought to the laboratory in plastic vials, washed with distilled water, incised and plated on NGM (Nematode Growth Medium) plates. The nematodes were extracted from soil samples by Cobb's (1918) sieving, decantation, and modified Baermann's funnel techniques (Baermann 1917).

### Light microscopy

For light microscopic observations, the nematodes were fixed in 4% formaldehyde, processed to anhydrous glycerin (Seinhorst, 1959), and mounted on glass slides using the wax ring method (De Maeseneer & D'Herde 1963). The nematodes were measured with an ocular micrometer, illustrated using a drawing tube, and photographed by a Jenoptik 'ProgRes' digital camera attached to an Olympus BX-51 DIC microscope.

### Scanning electron microscopy

For scanning electron microscopic observations, the methodology of Mahboob *et al.* (2021) was followed. In brief, nematodes were fixed in SEM fixative for 24 hours, washed in phosphate buffer, and dehydrated in an ethanol series. The dehydrated nematodes were dried in a Critical Point Dryer (CPD) using CO<sub>2</sub>. The nematodes were mounted on a stub on double-sided adhesive tape and coated with 10 nm gold before observing at 10 kV under a scanning electron microscope, model JEOL XL30 FEG.

## Cladistic analysis

### Characters and character states

Twenty-two morphological characters as listed in Appendix 1 were selected for the analysis. All the characters were important and informative with context to the differentiation of species of *Pelodera*. The characters were ranked based on the commonality principle. Character state '0' represented the most commonly occurring trait. A data matrix (Appendix 2) was prepared using character states for different species of the genus. Owing to ancestral similarity, *Rhomborhabditis stammeri* (Völkl, 1950) was taken as an outgroup.

### Data analysis

For the analyses, the phylogenetic tree was constructed for fourteen species containing 22 characters using MrBayes ver. 3.1.2 (Huelsenbeck & Ronquist 2001). The Jukes-Cantor (JC) model was selected for the analysis. The analysis was run with the Markov Chain Monte Carlo (MCMC) for  $1 \times 200\,000$  generations. Markov chains were sampled at intervals of 100 generations (Larget & Simon 1999). The samples of every 100 generations were discarded as "burn-in" and the consensus tree with a 50% majority rule was used for analysis. The tree was visualized and edited in FigTree ver. 1.4.0 (Rambaut 2012).

### Deposition of specimens

One male paratype and one female paratype each of *P. indica* sp. nov., *P. adeeli* sp. nov., and *P. paratretzeli* sp. nov. and specimens of *P. cylindrica* were deposited in the Nematode Collection of the Zoological Survey of India (ZSI), Kolkata, whereas the remaining paratypes and holotypes of the above-mentioned species were deposited in the Nematode Collection, Department of Zoology, Aligarh Muslim University (AMU/ZD/NC), India.

## Results

### *Systematics and taxonomy*

Phylum Nematoda Potts, 1932  
Class Chromadorea Inglis, 1983  
Order Rhabditida Chitwood, 1933  
Suborder Rhabditina Chitwood, 1933  
Infraorder Rhabditomorpha De Ley & Blaxter, 2002  
Family Rhabditidae<sup>1</sup> Örley, 1880  
  
Genus *Pelodera* Schneider, 1866

### Type species

*Pelodera strongyloides* (Schneider, 1860).

### Diagnosis

Body medium-large sized. Cuticle annulated, with or without punctations. Sexual dimorphism often exists with female having offset, distinctly expanded lip region. Lips six, globular, well-separated; labial sensilla papilliform. Amphids labial with small openings. Stoma with distinguishable or indistinguishable

---

<sup>1</sup>De Ley & Blaxter (2002, 2004) considered the superfamily Mesorhabditoidea parallel to Rhabditoidea based on the molecular sequences of selected taxa. Sudhaus (2011) following a comprehensive analysis of taxa recognized family Rhabditidae as a paraphyletic group, thus including all the taxa of Mesorhabditoidea. Sudhaus's (2011) concept of Rhabditidae has been accepted.

pharyngeal collar. Glottoid apparatus conspicuous, with well-developed, setose denticles. Pharynx well-developed, highly muscular with prominent metacorporeal swelling and a muscular, rounded to ovoid basal bulb. Rectum with or without a dilated lumen. Rectal glands distinguishable or not distinguishable. Reproductive system didelphic, amphidelphic with paired ovaries. Oocytes with prominent nuclei, arranged in multiple rows around the rachis at distal end. Uterus divided into well-developed glandular and muscular parts. Intra-uterine eggs often present. Vagina thick-walled. Vulva transverse slit with protruded lips. Male with spicules distally fused. Gubernaculum slender, trough-shaped. Genital papillae nine pairs. Bursa peloderan, anteriorly closed or open, with or without punctations. Tail elongate-conoid to cupola-shaped, with or without spike. Phasmidial opening conspicuous.

*Pelodera indica* sp. nov.

urn:lsid:zoobank.org:act:AE90DC74-C667-4E6B-AE39-D400BF61F43A

Figs 1–3, 13–15; Tables 1, 5–6; Appendices 1–2

**Diagnosis**

The new species *Pelodera indica* sp. nov. is characterized by transversely and longitudinally striated cuticle; sexual dimorphism in anterior region with females having conspicuously expanded, offset lip region; lips distinctly separated with tapering ends directed towards oral aperture; laterals larger than submedians; stoma wide, having three strong setose denticles on each metastegostomal plate; secretory-excretory pore at level of basal bulb or cardia; distal end of ovaries reaching up to vulva, often crossing each other; bursa peloderan, anteriorly closed; velum punctated with two deep grooves on either side; genital papillae nine pairs, compactly placed arranged in 0/1+1+1+1+1+P+3+1 configuration; without any gap between pre- and post cloacals; GP1 anteriorly directed with base located at level of posterior cloacal lip; GP1, GP4 and GP9 opening dorsally; genital papillae GP6–8 basally fused.

**Etymology**

The species name is derived from the name of the country ‘India’.

**Material examined**

**Holotype**

INDIA • ♂; Eastern Uttar Pradesh, Terai region, District Sidharthnagar; 27°08'37.38" N, 82°38'59.65" E; 309 m a.s.l.; isolated from the elytra (front wing) of dung beetles *Catharsius molossus* (Coleoptera: Scarabaeidae) (the beetle specimens were destroyed due to dissection/excision); AMU/ZD/NC slide no. *Pelodera indica* sp. nov./NIT/ctrs/1.

**Paratypes**

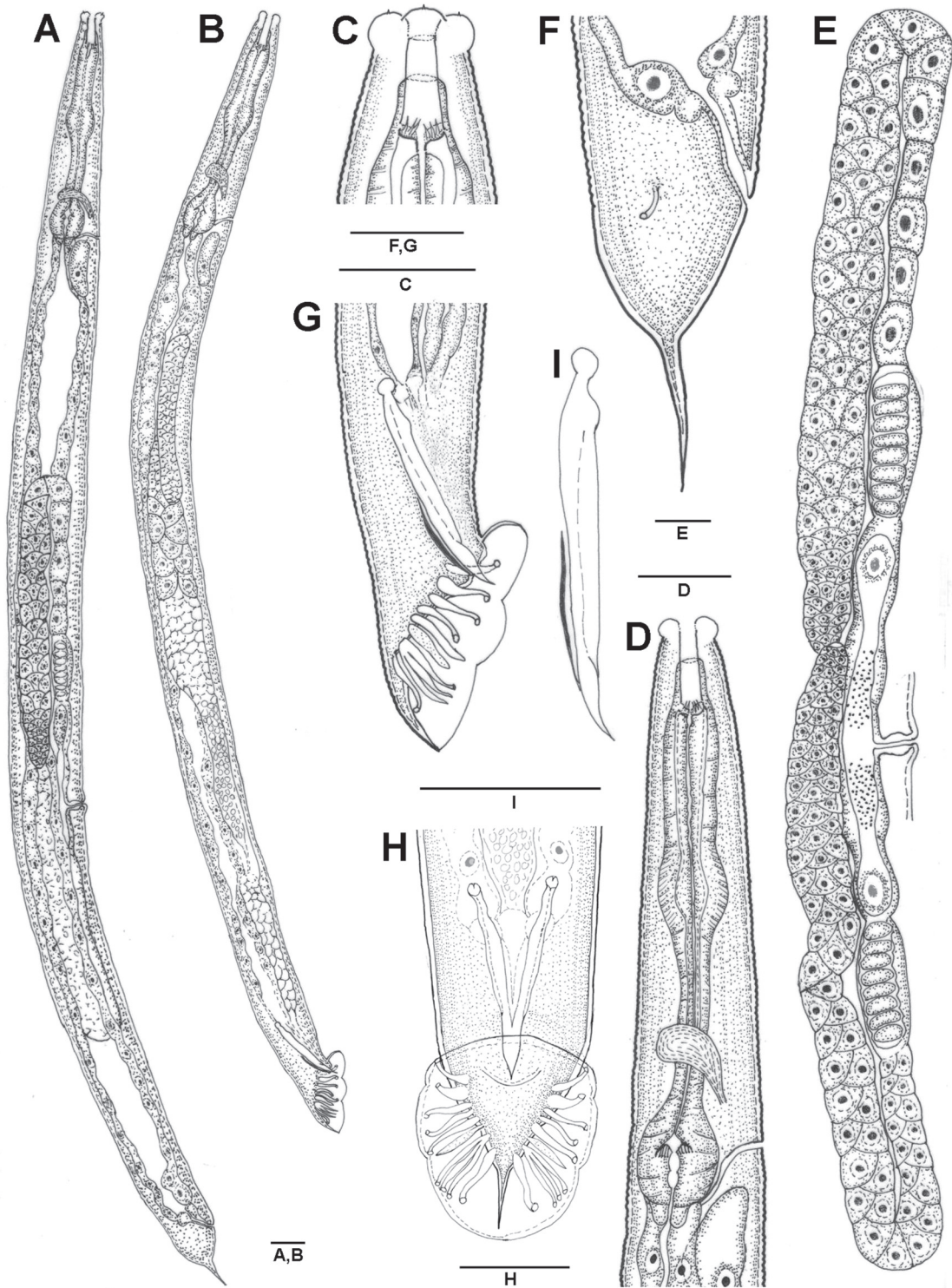
INDIA • 9 ♂♂, 9 ♀♀, 5 juvs; same collection data as for holotype; AMU/ZD/NC slide no. *Pelodera indica* sp. nov./NIT/ctrs/2–15.

**Description**

**Adult**

Body medium-sized, almost straight to slightly ventrally arcuate, tapering at both extremities. Cuticle 1 µm thick, finely annulated, with fine longitudinal lines and inconspicuous punctations. Lip region showing sexual dimorphism, with females having 2.5–3.0 times as wide as high, offset lip region more expanded than in males. Lips six, globular, distinctly separated with tapering ends projecting into stomal cavity; lateral lips larger than submedians. Labial sensilla papilliform. Amphids labial with small openings indiscernible under LM. Stoma well-developed, posteriorly widened, ca 3–4 times as long as wide or 13.1–13.4% of pharyngeal length. Cheilostom small, rod-shaped, cuticularized. Gymnostom with parallel walls, strongly cuticularized. Stegostom covering about 45–46% of stoma from its base.





**Fig. 1.** *Pelodera indica* sp. nov., paratypes (AMU/ZD/NC slide no. *Pelodera indica* sp. nov./NIT/ctrs/2–15). **A.** Entire female. **B.** Entire male. **C.** Female anterior region. **D.** Female pharyngeal region. **E.** Female reproductive system. **F.** Female posterior region. **G.** Male posterior region (lateral view). **H.** Male posterior region (ventral view). **I.** Spicule (lateral view). Scale bars = 25 µm.

Metastegostom anisoglottoid, relatively widened with three strongly developed, thorn-like setose denticles on each plate. Telostegostom heavily cuticularized. Pharynx well-developed, highly muscular, divided into 65–70  $\mu\text{m}$  long corpus with prominent metacorporeal swelling, a slightly narrower 39–49  $\mu\text{m}$  long isthmus, and a muscular, rounded to ovoid basal bulb of 26–31  $\mu\text{m}$   $\times$  25–28  $\mu\text{m}$  dimension with a well-developed grinder and two-chambered haustrulum. Nerve ring encircling posterior region of isthmus at ca 71–82% of pharyngeal length. Secretory-excretory duct opening at level of basal bulb, at ca 82.8–98.2% of pharyngeal length. Intestine with wide lumen, often dilated at anterior and posterior ends to form bacterial pouches with intestinal epithelium thinning out in the region; intestinal lumen refractive. Rectum 20–26  $\mu\text{m}$  long, shorter than anal body diameter often with dilated lumen; rectal glands distinct. A thick-walled, conspicuous pre-rectal pouch observed in one specimen.

### **Female**

Reproductive system didelphic, amphidelphic; ovaries paired, lateroventrally reflexed with distal parts often crossing each other. Oocytes with prominent nuclei, arranged in multiple rows around rachis towards distal end. Spermathecae filled with stacked spermatozoa. Each uterus divided into well-developed glandular and muscular parts; two pairs of glandular cells opening at proximal end of vagina. Intra-uterine eggs about 6–10, linearly arranged end to end or obliquely placed. Vagina thick-walled. Vulva transverse slit with protruded vulval lips. Tail cupola-shaped with a moderately developed spike of ca  $\frac{1}{2}$  of tail length. Phasmids opening laterally at level or just posterior to anus.

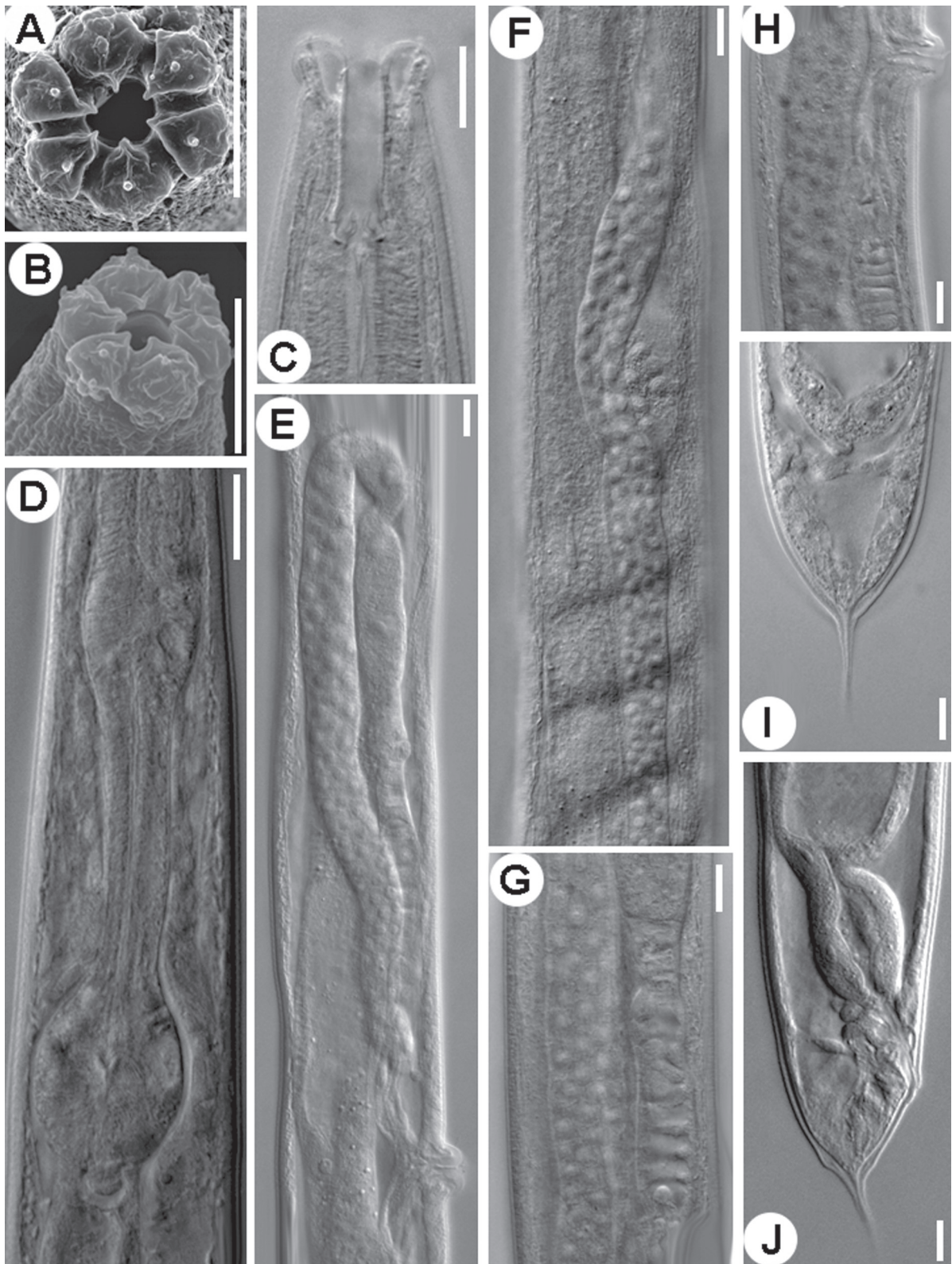
### **Male**

Similar to female in general morphology except for relatively narrower lip region and body having greater ventral curvature posteriorly. Lip region narrow, continuous, or slightly offset from body contour. Lips relatively smaller than those of female, laterals larger than submedians. Testis single, dorsally or laterally reflexed, on right side of intestine. Spermatozoa arranged in multiple rows; seminal vesicle separated from vas deferens by a deep constriction. Tail conoid, tapering posteriorly to an acute terminus. Spicules with rounded capitulum, narrow neck and slender shaft, fused distally up to 24–28% of total length. Gubernaculum slender, trough-shaped, 37–51% of spicule length. Genital papillae nine pairs, evenly spaced and arranged in 0/1+1+1+1+1+P+3+1 configuration, without any gap in between. GP1 slender, directed towards anterior edge of bursa, with base located at posterior cloacal lip or beyond. GP2 relatively plump. GP1, GP4 and GP9 opening dorsally. Bursa well-developed, anteriorly closed, transversely and longitudinally striated with dot-like punctations. Anterior bursal rim close to cloacal opening, bursal velum appearing lobed under LM, forming two deep grooves at GP2 and GP5. Phasmids relatively plump and shorter, located in between GP5 and group of GP6–8. Genital papillae GP6–8 basally fused.

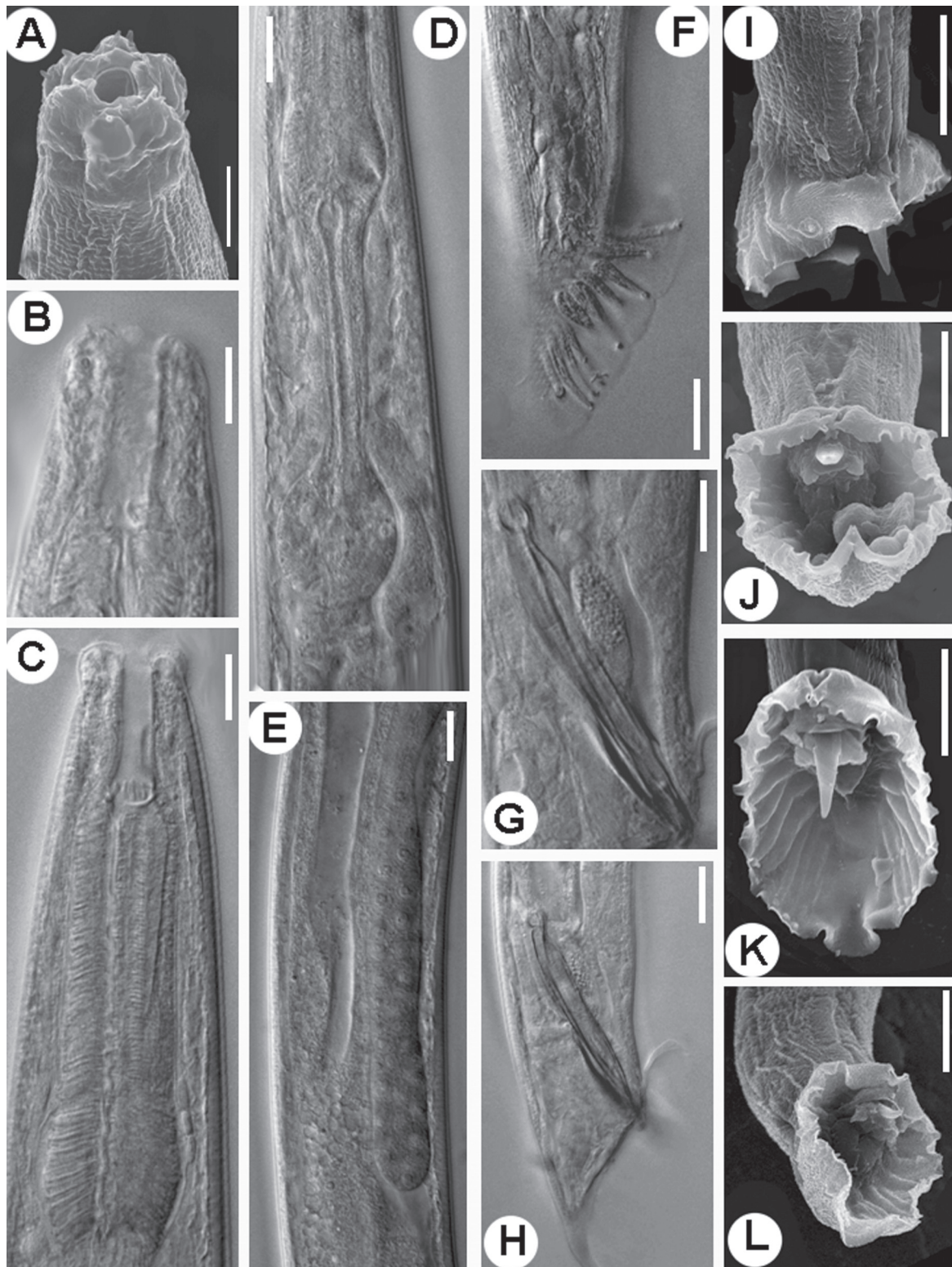
### **Dauer/phoretic juvenile**

Body often straight or slightly ventrally arcuate upon fixation. Cuticle thin, ca 0.1–0.5  $\mu\text{m}$ . Lateral field inconspicuous. Lip region continuous. Lips amalgamated, not differentiated into six separate lips. Oral aperture covered by a highly sclerotized cuticular plug. Stoma long, narrow, ca 5–6 times as long as wide. Metastegostomal swellings with faintly visible denticles. Pharynx weakly developed with slender procorpus 42–56  $\mu\text{m}$  long; a swelling metacorpus 11–15  $\times$  10–12  $\mu\text{m}$  in dimension and a narrow, long, isthmus of 25–36  $\mu\text{m}$ , expanded posteriorly to an oval basal bulb 15–25  $\times$  12–17  $\mu\text{m}$  in dimension, having weakly-developed grinder. Nerve ring encircling mid or posterior region of isthmus. Secretory-excretory duct inconspicuous. Cardia short, conoid. Rectum shorter than anal body diameter. Rectal glands inconspicuous. Phasmidial aperture inconspicuous. Tail long, conoid, ending with a sharp, pointed tip.





**Fig. 2.** *Pelodera indica* sp. nov., paratype, ♀ (AMU/ZD/NC slide no. *Pelodera indica* sp. nov./NIT/ctrs/2–15). **A–B.** En face view (scanning electron microscopy). **C.** Anterior end. **D.** Posterior pharyngeal region. **E.** Vulval region with anterior genital branch (lateral view). **F.** Anterior genital branch. **G.** Posterior genital branch. **H.** Vulval region. **I–J.** Tail. Scale bars = 10  $\mu$ m.



**Fig. 3.** *Pelodera indica* sp. nov., paratype, ♂ (AMU/ZD/NC slide no. *Pelodera indica* sp. nov./NIT/ctrs/2–15). A. Anterior region (scanning electron microscopy). B. Anterior end. C. Anterior pharyngeal region. D. Posterior pharyngeal region. E. Ovarian flexure of anterior genital branch. F–H. Posterior region showing spicules and gubernaculum. I–L. Tail region showing bursa and genital papillae (scanning electron microscopy). Scale bars = 10  $\mu$ m.



**Table 1.** Morphometric data of adult and dauer/phoretic juveniles of *Pelodera indica* sp. nov. Measurements are in  $\mu\text{m}$  and in the form: mean  $\pm$  standard deviation (range).

Character	Holotype $\sigma$	Paratypes $\sigma\sigma$	Paratypes $\text{♀♀}$	Dauer/phoretic juveniles
n	–	(10 $\sigma\sigma$ )	(10 $\text{♀♀}$ )	(5 juvs)
Body length	670	668.7 $\pm$ 44.3 (591–727)	934.3 $\pm$ 76.2 (849–1065)	516.2 $\pm$ 57.2 (404–570)
Body diam.	40	40.3 $\pm$ 3.5 (33–45)	58.9 $\pm$ 7.5 (50–72)	29.7 $\pm$ 3.4 (26–34)
a	16.7	16.6 $\pm$ 1.9 (15.4–22.0)	16.0 $\pm$ 1.7 (13.7–18.6)	17.5 $\pm$ 1.7 (15.5–19.6)
b	4.6	4.5 $\pm$ 0.4 (4.1–5.3)	5.7 $\pm$ 0.4 (5.5–6.2)	4.6 $\pm$ 0.4 (4.0–5.0)
c	16.7	15.7 $\pm$ 1.4 (13.8–18.1)	17.6 $\pm$ 2.0 (14.7–21.1)	5.8 $\pm$ 0.3 (5.4–6.2)
c'	1.4	1.5 $\pm$ 0.1 (1.4–1.7)	1.5 $\pm$ 0.2 (1.1–1.8)	5.0 $\pm$ 0.3 (4.4–5.4)
V/T	71.6	78.0 $\pm$ 7.3 (71.6–96.2)	61.1 $\pm$ 2.2 (55.5–63.2)	–
G1	–	–	55.7 $\pm$ 7.6 (48.6–69.4)	–
G2	–	–	46.1 $\pm$ 8.3 (35.2–63.4)	–
Lip region height	5	5.4 $\pm$ 0.5 (5–6)	6.5 $\pm$ 1.0 (5–8)	3.3 $\pm$ 0.5 (3–4)
Lip region diam.	16	14.3 $\pm$ 0.7 (14–16)	17.0 $\pm$ 0.9 (16–19)	9.7 $\pm$ 0.5 (9–10)
Stoma length	23	24.4 $\pm$ 1.4 (22–27)	26.7 $\pm$ 1.8 (24–29)	20.3 $\pm$ 1.6 (19–23)
Stoma diam.	7	6.1 $\pm$ 0.3 (6–7)	7.0 $\pm$ 0.7 (6–8)	3.7 $\pm$ 0.8 (3–5)
Pharynx length	143	145 $\pm$ 5.7 (137–154)	162.9 $\pm$ 7.0 (154–175)	111.7 $\pm$ 10.2 (100–130)
Nerve ring from anterior end	110	109.2 $\pm$ 6.0 (102–122)	127.5 $\pm$ 9.1 (110–145)	85.7 $\pm$ 2.5 (83–90)
Secretory-excretory pore from anterior end	140	133.7 $\pm$ 10.1 (113–152)	157.2 $\pm$ 8.4 (145–172)	–
Rectum length	36	41.4 $\pm$ 4.6 (35–50)	23.7 $\pm$ 2.1 (20–26)	23.3 $\pm$ 2.6 (19–26)
Anal body diam.	28	26.5 $\pm$ 1.4 (24–29)	35.8 $\pm$ 3.6 (32–42)	18.0 $\pm$ 2.0 (16–21)
Vulva–Anus distance	–	–	338.3 $\pm$ 42.7 (290–425)	–
Egg length	–	–	55.3 $\pm$ 4.8 (45–68)	–
Egg diam.	–	–	38.2 $\pm$ 3.8 (35–45)	–
Spicule length	52	52.2 $\pm$ 3.2 (45–57)	–	–
Gubernaculum length	21	20.9 $\pm$ 2.2 (17–24)	–	–
Tail length	40	42.9 $\pm$ 2.8 (40–46)	53.8 $\pm$ 7.6 (41–62)	(89.2 $\pm$ 11.7 (70–105))



## Remarks

*Pelodera indica* sp. nov. comes closer to *P. cylindrica* (Cobb, 1898) in most of the morphometric and morphological characters but differs in having females with smaller *c* (14.7–21.1 vs 38.6–70.9) and greater *c'* (1.1–1.8 vs 0.5–0.6) values; tail cupola-shaped (vs hemispheroid) with (vs without) spike and males with spicules having rounded (vs elongated) capitula, fused up to 24–28% (vs 15–20%) at distal end; bursa lobed (vs not lobed in *P. cylindrica* fide Sachs (1950), Völk (1950) and Osche (1952)).

The new species resembles *P. isociensis* (Maupas, 1916) in most morphometric characters but differs in having smaller females (849–1065 µm vs 1214–1830 µm); smaller *c* (14.7–21.1 vs 30.3–57.3) value; tail spike as long as (vs one third) of anal body diameter; males with GP2 and GP3 relatively closer (vs spaced in *P. isociensis* fide Sachs (1950)).

The new species also differs from *P. tretzeli* (Sachs, 1950) in having females with smaller body (849–1065 µm vs 1543–3327 µm); smaller *b* (5.1–6.2 vs 8.1–11.9) and *c* (14.7–21.1 vs 28.4–33.1) values; phasmids present at level of (vs posterior to) anus; males with smaller *c* (13.8–18.1 vs 28.4–35.6) value; larger spicules (45–57 µm vs 32–39 µm); pre cloacal genital papillae absent (vs present); GP3 close to (vs distant from) GP4; bursa with two notches (vs one notch) and anterior rim of bursa close to (vs distant from) cloacal opening in *P. tretzeli* fide Sachs (1950)).

*Pelodera indica* sp. nov. differs from *P. voelki* (Sachs, 1950) in having females with smaller body (849–1065 µm vs 1470–3610 µm), smaller *b* (5.1–6.2 vs 7.6–9.6) and *c* (14.7–21.1 vs 25.8–36.3) values; males having smaller body (591–727 µm vs 885–1625 µm), and relatively smaller *b* (4.1–5.3 vs 5.3–6.1) and *c* (13.8–18.1 vs 21.6–26.7) values; smaller spicules (45–47 µm vs 51–70 µm); genital papillae compactly placed (vs spaced); pre cloacals absent (vs present); GP2 relatively plump (vs slender); GP2 and GP3 closely (vs distantly) placed; anterior bursal rim just ahead of cloaca (vs distant from cloaca in *P. voelki* fide Sachs (1950)).

The new species differs from *P. aligarhensis* Tahseen *et al.*, 2014 in having females with relatively larger body length (849–1065 µm vs 688–841 µm); greater *b* (5.1–6.2 vs 3.9–4.6) and relatively smaller *c* (14.7–21.1 vs 22.1–41.2) values; longer tail spike (20–31 µm vs 5.9 µm); males with larger spicules (45–57 µm vs 30–38 µm); anterior bursal rim just anterior to (vs distant from) cloacal opening; pre cloacal genital papillae shifted (vs not shifted) posterior to cloaca; genital papillae not arranged in groups (vs arranged in three groups in *P. aligarhensis*).

### *Pelodera adeeli* sp. nov.

urn:lsid:zoobank.org:act:40B1FCCA-69E5-4C95-957D-3B40DD68E7F2

Figs 4–6, 13–15; Tables 2, 5–6; Appendices 1–2

## Diagnosis

The new species *P. adeeli* sp. nov. is characterized by the absence of sexual dimorphism in anterior region; cuticle transversely and longitudinally striated; lips equal, strongly offset with loose cuticular margins; stoma 4.5–5.0 times as long as wide with three well-developed, relatively small setose denticles on each metastegostomal plate; secretory-excretory pore located nearly at level of pharyngo-intestinal junction; distal ends of ovaries crossing each other; vulval lips strongly protruded; tail pedomorphic with retention of juvenile cuticle, conoid, regularly tapering to acute terminus; males with slender spicules, rounded capitulum, long neck, shaft fused distally; gubernaculum ca 1/3–1/4 of spicule length; bursa peloderan, anteriorly closed and punctated with serrated margins, anterior rim of bursa distant from cloacal opening; genital papillae nine pairs: two pre cloacal and seven post cloacal pairs arranged in 2/1+2+Ph+3+1 configuration with wide gap between GP2, GP3 and GP4.

### Etymology

The species name is given in honour of Mr Mohammad Adeel, the father of Mohammad Mahboob.

### Material examined

#### Holotype

INDIA • ♂; Eastern Uttar Pradesh, Terai region, District Gonda; 27°08'37.38" N, 82°38'59.65" E; 309 m a.s.l.; isolated from the elytra (front wing) of dung beetle, *Onthophagus ramosus* (Wiedeman, 1823) (Coleoptera: Scarabaeidae) (the beetle specimens were destroyed due to dissection/excision); AMU/ZD/NC slide no. *Pelodera adeeli* sp. nov./NIT/rpt/1.

#### Paratypes

INDIA • 3 ♂♂, 5 ♀♀, 5 juvs; same collection data as for holotype; AMU/ZD/NC slide no. *Pelodera adeeli* sp. nov./NIT/rpt/2–10.

### Description

#### Adult

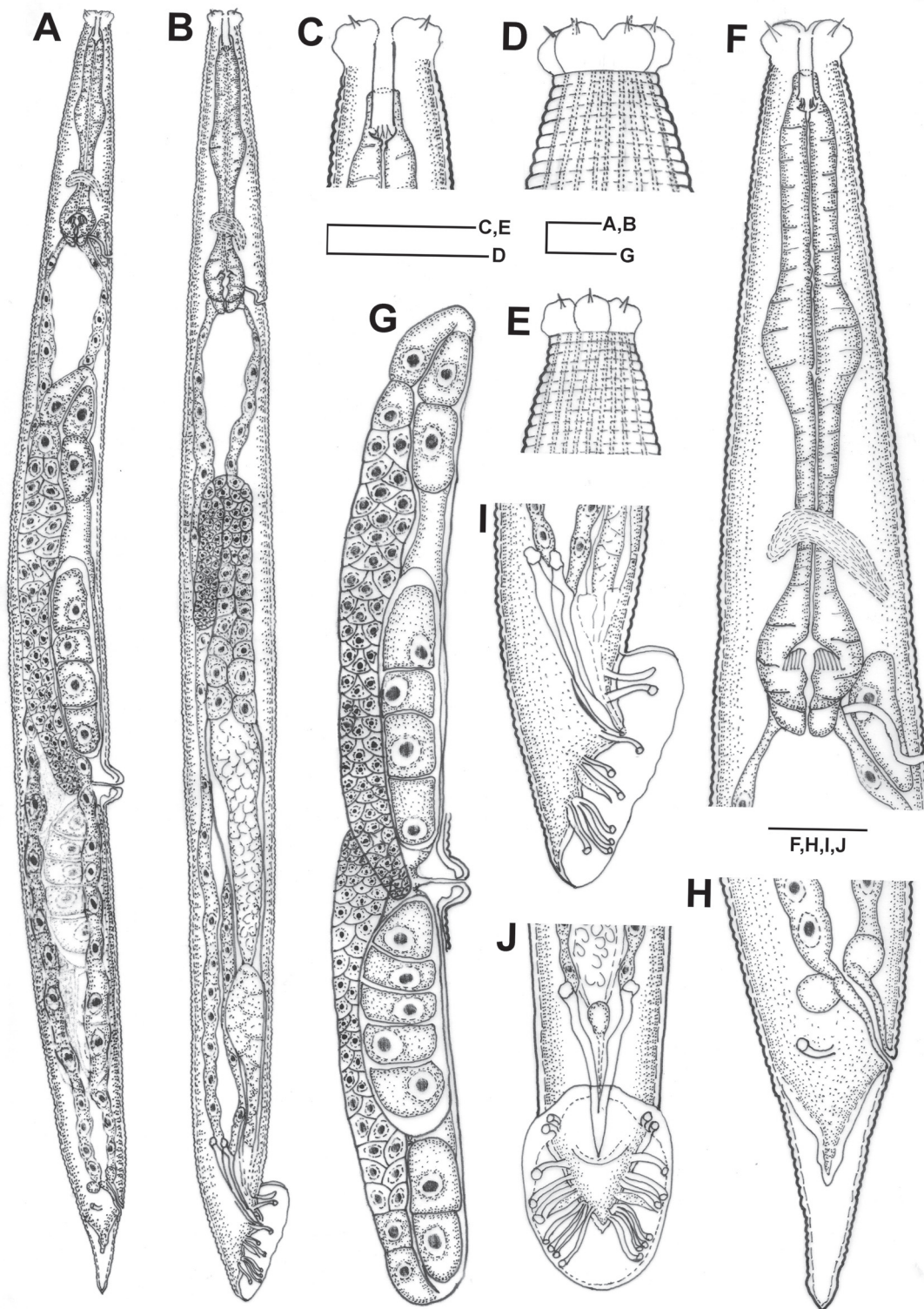
Body medium-sized, obese, stout, almost straight, tapering at both extremities. Cuticle annulated, 2 µm thick with annules 1.0–1.5 µm wide at pharyngeal region and 3–4 µm wide at mid-body. Longitudinal striations relatively prominent, extending up to tail, crossed by transverse striation to form corn cob pattern. Sexual dimorphism indistinct in anterior region with lip region offset from body contour and 2.5–3.0 times as wide as high. Lips six, equal-sized with loose margins, globular in shape, distinctly separated, containing slightly raised labial sensilla. Amphids labial with small, rounded apertures. Stoma well-developed, ca 4.5–5.0 times as long as wide or 13–14% of total pharyngeal length. Cheilostom highly cuticularized; gymnostom relatively narrower than stegostom; stegostom more than half of stoma length, surrounded by pharyngeal tissue at about 56.5–57.4% of stoma length; metastegostom with three prominent setose denticles on each swelling; telostegostom heavily cuticularized. Pharynx well-developed, divided into muscular, 60–66 µm long, slender corpus, well-developed, highly muscular metacarpus of 22–26 × 21–25 µm dimension, and isthmus relatively narrower, 40–45 µm long, expanding posteriorly to form well-developed basal bulb of 27–32 × 24–26 µm dimension, having a grinder and double-chambered haustrulum. Cardia conoid, 5–7 µm long. Nerve ring encircling posterior region of isthmus at 67.8–68.7% of pharyngeal length from anterior end. Secretory-excretory duct usually opening posterior to pharynx at 96.2–105% from anterior end. Intestine with wide lumen, often anteriorly and posteriorly dilated to form bacterial pouches with intestinal epithelium thinning out in the region; intestinal lumen refractive. Rectum 24–28 µm long, approximately equal to anal body diameter, occasionally with dilated lumen. Tail pedomorphic, retaining larval cuticle, conoid in shape, ca twice of anal body diameter. Phasmids tubular, opening slightly posterior to anus.

#### Female

Reproductive system didelphic, amphidelphic; ovaries well-developed, paired, opposed, and lateroventrally reflexed, usually distal ends of ovaries extended beyond vulva, crossing each other. Oocytes with prominent nuclei arranged in multiple rows. Usually, two uterine eggs present at different stages of embryonation. Vagina thick-walled. Vulva rounded in shape with strongly protruded vulval lips, situated posterior to the mid-body or at 57.7–60.0% from the anterior end.

#### Male

Similar to female in general morphology except prominently curved posterior region. Testis single, dorsally reflexed, on right lateral side of intestine. Spermatocytes arranged in multiple rows. Seminal vesicle filled with spermatids continuing into vas deferens. Vas deferens narrowing posteriorly to form a narrow ejaculatory duct. A pair of ejaculatory glands present. Tail conical, ending in an acute terminus. Bursa well-developed, anteriorly closed, oval in shape, transversally and longitudinally striated with dot-



**Fig. 4.** *Pelodera adeeli* sp. nov., paratypes (AMU/ZD/NC slide no. *Pelodera adeeli* sp. nov./NIT/rpt/2–10). **A.** Entire female. **B.** Entire male. **C–D.** Female anterior end. **E.** Male lip region. **F.** Female pharyngeal region. **G.** Female reproductive system. **H.** Female posterior region. **I.** Male posterior region (lateral view). **J.** Male posterior region (ventral view). Scale bars = 25 µm.



like punctations. Bursal margins crenate. Anterior bursal velum distant from cloacal opening. Spicules slightly ventrally curved, slender with rounded capitulum, narrow necks and conspicuous ventral conoid process, fused distally up to 20–22% of total length. Gubernaculum slender, trough-shaped, ca 22–25% of spicule length. Genital papillae nine pairs in 2/1+2+P+3+1 configuration. Pre cloacals GP1 and GP2 similar in shape and size, directed towards anterior velum of bursa. GP3 situated just posterior to cloaca. GP4, GP5 and phasmid closely placed while GP4 far from GP3. Phasmid relatively shorter and plump, GP6–8 basally fused, equal in shape and size. GP9 open dorsally, close to group of GP6–8.

#### Dauer/phoretic juvenile

Body straight, tapering at both extremities, more towards posterior region. Cuticle thin, ca 0.1–0.3  $\mu\text{m}$ . Lateral field with single line or incisor. Lip region continuous. Stoma long, narrow, ca 6–7 times as long as wide. Metastegostomal swellings weakly-developed with faintly visible small denticles. Pharynx well-developed with slender procorpus 38–45  $\mu\text{m}$  long, a swollen metacorpus of 12–15  $\mu\text{m} \times 11$ –12  $\mu\text{m}$  dimension and a narrow, long isthmus of 28–32  $\mu\text{m}$ , expanded posteriorly to an oval basal bulb of 15–17  $\mu\text{m} \times 12$ –12  $\mu\text{m}$  dimension, having weakly-developed grinder. Nerve ring encircling mid-region of isthmus. Secretory-excretory duct inconspicuous. Bacterial chamber present. Rectum shorter than anal body diameter. Rectal glands prominent. Tail long, conoid, ending with filiform tip.

#### Remarks

*Pelodera adeeli* sp. nov. comes closer to *P. cylindrica* (Cobb, 1898) in most morphometric and morphological characteristics but differs in sexual dimorphism absent (vs present); females having smaller  $c$  (12.5–17.2 vs 38.6–70.5) and greater  $c'$  (1.7–2.1 vs 0.5–0.6) values; labial sensilla slightly raised (vs minute); metastegostomal denticles relatively smaller (vs larger); lip margins loose (vs defined); posteriorly located secretory-excretory pore 96.2–105.0% (vs 53–75%) of pharyngeal length; tail conoid (vs hemispheroid); males with pre cloacal genital papillae not shifted posteriorly (vs shifted posteriorly in *P. cylindrica* fide Sachs (1950) and Völk (1950)).

The new species differs from *P. par* Andrassy, 1962 in having females with smaller  $a$  (11.6–13.9 vs 18.5),  $b$  (4.2–5.4 vs 7.1) and  $c$  (12.5–17.2 vs 27.5) values; labial sensilla raised (vs minute); stegostom slightly (vs strongly) expanded; tail conoid (vs cupola-shaped); males with smaller  $a$  (13.4–16.8 vs 22.7) and  $c$  (15.6–19.4 vs 21.0) values; gubernaculum ca  $\frac{1}{3}$ – $\frac{1}{4}$  of spicule length (vs half of spicule length); pre cloacal genital papillae 2 pairs (vs 3 pairs in *P. par*).

The new species resembles *P. cystilarva* (Völk, 1950) but differs in having females with smaller body size (678–934  $\mu\text{m}$  vs 1224–1744  $\mu\text{m}$ ); smaller  $b$  (4.2–5.4 vs 6.2–7.6) and  $c'$  (1.7–2.1 vs 2.6–6.7) values; greater  $c$  (12.5–17.2 vs 7.5–9.1) value; stoma 4.5–5.0 times (vs 6–7 times) as long as wide; rectum approximately equal to (vs half or less than) anal body diameter; tail conoid (vs dome-shaped); males with smaller body (577–722  $\mu\text{m}$  vs 880–1072  $\mu\text{m}$ ); greater  $a$  (13.4–16.8 vs 11.5–12.0) value; smaller  $b$  (4.0–4.8 vs 5.0–5.4) and  $c$  (15.6–19.4 vs 26.1–46.3) values; bursal velum expanded (vs relatively converging type in *P. cystilarva* fide Völk (1950)).

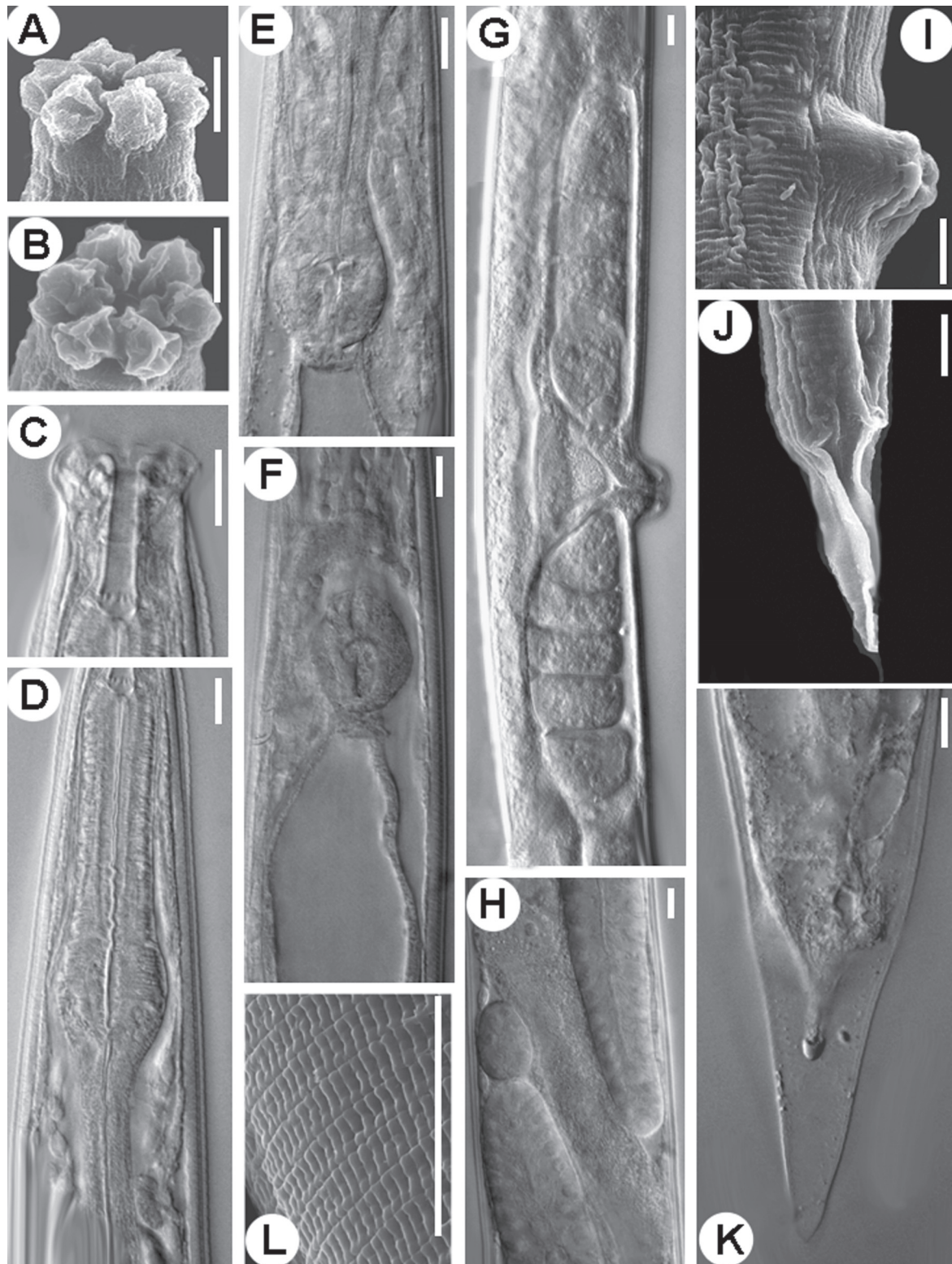
*Pelodera adeeli* sp. nov. comes close to *P. serrata* (Körner in Osche, 1952) but differs in having females with smaller body size (678–934  $\mu\text{m}$  vs 1148–1409  $\mu\text{m}$ ); smaller  $c$  (12.5–17.2 vs 37.0–50.7) value; secretory-excretory pore located at level of pharyngo-intestinal junction (vs at mid-level of isthmus); tail conoid (vs cupola-shaped); males with body shorter (577–722  $\mu\text{m}$  vs 1067–1242  $\mu\text{m}$ ); relatively smaller  $b$  (4.0–4.8 vs 4.8–5.9) and  $c$  (15.6–19.4 vs 29.3–41.0) values; smaller spicules (37–50  $\mu\text{m}$  vs 68–80  $\mu\text{m}$ ) and genital papillae GP3 and GP4 distantly positioned (vs closely placed in *P. serrata* fide Körner in Osche (1952)).

The new species differs from *P. voelki* (Sachs, 1950) in having no sexual dimorphism (vs sexual dimorphism present); females with smaller body size (678–934  $\mu\text{m}$  vs 1470–3610  $\mu\text{m}$ ); smaller  $b$  (4.2–5.4 vs 7.6–9.6) and  $c$  (12.5–17.2 vs 25.8–36.3) values; metastegostomal denticles relatively small (vs long); stoma 4.5–5.0 times (vs 2.5–3.0 times) as long as wide; tail conoid (vs cupola-shaped); males

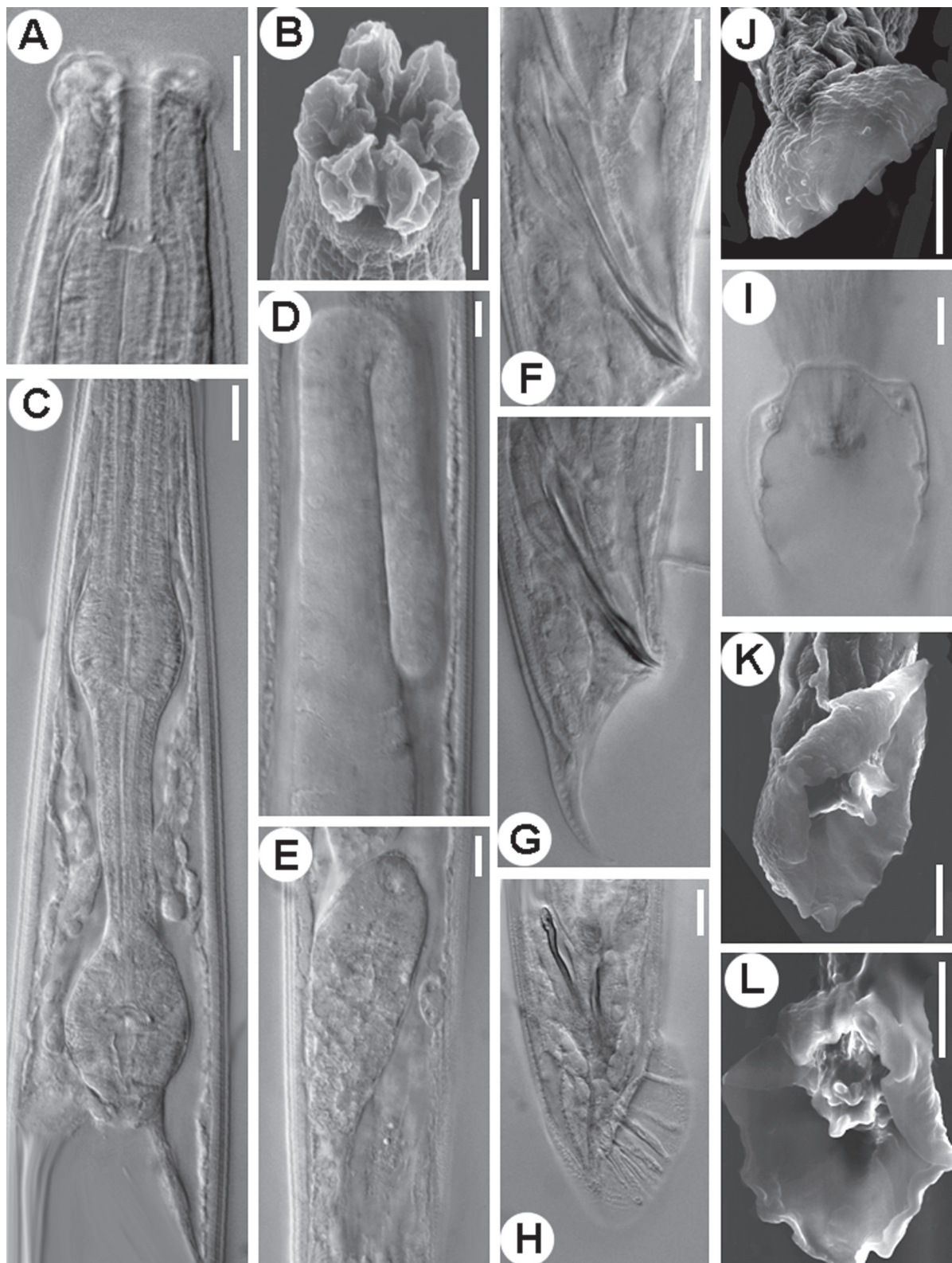
**Table 2.** Morphometric data of adult and dauer/phoretic juveniles of *Pelodera adeeli* sp. nov. Measurements are in  $\mu\text{m}$  and in the form: mean  $\pm$  standard deviation (range).

Character	Holotype ♂	Paratypes ♂♂	Paratypes ♀♀	Dauer/phoretic juveniles
n	–	(4 ♂♂)	(6 ♀♀)	(5 juvs)
Body length	628	660.8 $\pm$ 70.5 (577–722)	834.1 $\pm$ 96.1 (678–934)	347.8 $\pm$ 50.3 (318–423)
Body diam.	42	44.5 $\pm$ 3.7 (42–50)	63.8 $\pm$ 10.2 (50–80)	26.3 $\pm$ 1.0 (25–27)
a	15.0	14.9 $\pm$ 1.4 (13.4–16.8)	13.1 $\pm$ 0.8 (11.6–13.9)	13.3 $\pm$ 2.4 (11.8–16.9)
b	4.5	4.6 $\pm$ 0.4 (4.0–4.8)	5.0 $\pm$ 0.4 (4.2–5.2)	3.4 $\pm$ 0.8 (2.9–4.5)
c	16.5	17.4 $\pm$ 1.7 (15.6–19.4)	14.6 $\pm$ 1.5 (12.5–17.2)	7.4 $\pm$ 1.8 (5.0–9.1)
c'	1.5	1.4 $\pm$ 0.2 (1.2–1.6)	1.9 $\pm$ 0.1 (1.7–2.1)	2.9 $\pm$ 1.8 (1.8–5.7)
V/T	67.2	73.7 $\pm$ 4.8 (67.2–78.4)	59.2 $\pm$ 0.8 (57.7–60.0)	–
G1	–	–	57.0 $\pm$ 8.7 (41.5–64.5)	–
G2	–	–	50.8 $\pm$ 7.7 (36.1–57.4)	–
Lip region height	7	8.3 $\pm$ 1.0 (7–9)	8.5 $\pm$ 0.5 (8–9)	2.3 $\pm$ 0.5 (2–3)
Lip region diam.	17	16.3 $\pm$ 1.5 (15–18)	20.1 $\pm$ 1.1 (19–22)	9.0 $\pm$ 0.0 (9–9)
Stoma length	20	19.5 $\pm$ 0.6 (19–20)	22.0 $\pm$ 0.6 (21–23)	15.5 $\pm$ 2.1 (13–18)
Stoma diam.	4	4.0 $\pm$ 0.0 (4–4)	4.8 $\pm$ 0.4 (4–5)	2.3 $\pm$ 0.5 (2–3)
Pharynx length	139	145 $\pm$ 4.9 (139–149)	165.3 $\pm$ 5.2 (160–171)	102.5 $\pm$ 6.6 (93–108)
Nerve ring pore from anterior end	100	102.5 $\pm$ 6.1 (95–108)	113.6 $\pm$ 3.2 (110–116)	67.5 $\pm$ 2.1 (65–70)
Secretory-excretory pore from anterior end	135	138.3 $\pm$ 9.4 (127–149)	162 $\pm$ 11.0 (154–180)	–
Rectum length	30	34.3 $\pm$ 4.3 (30–40)	25.2 $\pm$ 1.6 (24–28)	15.0 $\pm$ 0.0 (15–15)
Anal body diam.	26	26.8 $\pm$ 2.2 (25–30)	28.6 $\pm$ 2.5 (25–31)	18.5 $\pm$ 2.4 (15–20)
Vulva–Anus distance	–	–	283.1 $\pm$ 35.0 (218–314)	–
Egg length	–	–	65.8 $\pm$ 2.6 (64–70)	–
Egg diam.	–	–	22.8 $\pm$ 3.1 (22–28)	–
Spicule length	47	44.8 $\pm$ 5.6 (37–50)	–	–
Gubernaculum length	10	9.8 $\pm$ 1.0 (9–11)	–	–
Tail length	38	38.0 $\pm$ 1.4 (37–40)	57.0 $\pm$ 5.6 (50–64)	50.8 $\pm$ 23.1 (35–85)





**Fig. 5.** *Pelodera adeeli* sp. nov., paratype, ♀ (AMU/ZD/NC slide no. *Pelodera adeeli* sp. nov./NIT/rpt/2–10). **A–B.** En face view (scanning electron microscopy). **C.** Anterior end. **D.** Anterior pharyngeal region. **E–F.** Posterior pharyngeal region. **G.** Reproductive system. **H.** Distal parts of ovaries. **I.** Vulval region (scanning electron microscopy). **J.** Tail region (scanning electron microscopy). **K.** Tail with old cuticle. **L.** Cuticular markings (scanning electron microscopy). Scale bars = 10 µm.



**Fig. 6.** *Pelodera adeeli* sp. nov., paratype, ♂ (AMU/ZD/NC slide no. *Pelodera adeeli* sp. nov./NIT/rpt/2–10). **A.** Anterior end. **B.** En face view (scanning electron microscopy). **C.** Pharyngeal region. **D.** Reflexed part of testis. **E.** Ejaculatory gland. **F–H.** Posterior region (lateral view). **I.** Posterior region (ventral view). **J–L.** Posterior region (scanning electron microscopy). Scale bars = 10 µm.



shorter (577–722  $\mu\text{m}$  vs 885–1625  $\mu\text{m}$ ), with relatively smaller *a* (13.4–16.8 vs 16.3–20.0), *b* (4.0–4.8 vs 5.3–6.1) and *c* (15.6–19.4 vs 21.6–26.7) values; smaller spicules (37–50  $\mu\text{m}$  vs 51–70  $\mu\text{m}$ ); genital papillae GP1 and GP2 distant (vs close) to cloaca and GP3 distant from GP4 (vs close to GP4 in *P. voelki* fide Sachs (1950)).

The new species also differs from *P. kolbi* (Sachs, 1950) in not showing (vs showing) sexual dimorphism; females with smaller body length (678–934  $\mu\text{m}$  vs 1185–1326  $\mu\text{m}$ ); smaller *b* (4.2–5.4 vs 5.9–7.9) and *c* (12.5–17.2 vs 21.9–27.9) values; greater *c'* (1.7–2.1 vs 0.9–1.0) value; tail conoid (vs cupola-shaped); males with relatively smaller *a* (13.4–16.8 vs 16.1–18.1) value; genital papillae GP1 inside (vs outside) bursa; pre cloacal genital papillae (two pairs vs single pair); GP2 distantly ahead of cloaca (vs at level of cloaca) and GP4–5+P and GP6–8 arranged in groups (vs not arranged in groups in *P. kolbi* fide Sachs (1950)).

*Pelodera adeeli* sp. nov. differs from the Indian species, *P. aligarhensis* Tahseen *et al.*, 2014, in having sexual dimorphism absent (vs present); smaller *a* (11.6–13.9 vs 16.3–20.0) and *c* (12.5–17.2 vs 22.1–41.2) values; relatively greater *c'* (1.7–2.1 vs 0.8–1.4) value; labial margins wavy (vs compact); denticles relatively small (vs large); tail conoid (vs cupola-shaped); males with smaller *a* (13.4–16.8 vs 17.5–18.4) value; adcloacal papilla absent (vs present); GP3 distant (vs close to GP2 in *P. aligarhensis*).

***Pelodera paratretzeli* sp. nov.**

urn:lsid:zoobank.org:act:C4B7FC68-5CD4-4A07-8B72-E4B32459F209

Figs 7–9, 13–15; Tables 3, 5–6; Appendices 1–2

**Diagnosis**

*Pelodera paratretzeli* sp. nov. is characterized by conspicuous sexual dimorphism in anterior region with females having lip region strongly offset with well-developed, globular lips and males having lip region dome-shaped, continuous, with low, amalgamated lips; stoma 2.5–3.8 times as long as wide; metastegostom anisomorphic with three well-developed setose denticles on each sector; vulval lips not protruded, flanked by cuticular flaps; tail cupola-shaped with a long spike; spicules with rounded capitulum, long neck, fused up to 12–14% of spicule length; bursa peloderan, anteriorly closed and punctated; anterior bursal rim distant from cloacal opening; bursal velum lobed with a shallow groove at cloaca; genital papillae nine pairs: three pre cloacal and six post cloacals arranged in 3/2+Ph+3+1 configuration. GP1-3 closely placed. GP3 shorter than others. GP4, GP5 and relatively shorter and thickened phasmid forming a group, quite posterior to cloaca; GP6–8 basally fused, equal in shape and size.

**Etymology**

The species epithet '*paratretzeli*' indicates its close similarity with *P. tretzeli* (Sachs, 1950).

**Material examined**

**Holotype**

INDIA • ♀; Uttar Pradesh, District Aligarh; 27°08'37.38" N, 82°38'59.65" E; 309 m a.s.l.; isolated from the elytra (front wing) of dung beetle, *Digitonthophagus bonasus* (Coleoptera: Scarabaeidae) (the beetle specimens were destroyed due to dissection/excision); AMU/ZD/NC slide no. *Pelodera paratretzeli* sp. nov./HS/AL/ST/BS/1.

**Paratypes**

INDIA • 5 ♀♀, 5 ♂♂, 5 juvs; same collection data as for holotype; AMU/ZD/NC slide no. *Pelodera paratretzeli* sp. nov./HS/AL/ST/BS/2–12.

## **Description**

### **Adult**

Body medium-sized, plump, almost straight, with tapering ends. Sexual dimorphism conspicuous in anterior region. Cuticle with transverse and longitudinal striations and fine punctations. Lip region strongly offset from body contour and dilated, ca 2.6–3.2 times as wide as high. Lips globular, distinctly separated, with slightly raised labial sensilla. Amphids labial with small, elliptical apertures. Stoma well-developed, 2.5–3.8 times as long as wide or 11–14% of total pharyngeal length. Cheilostom highly cuticularized. Gymnostom with parallel walls. Stegostom surrounded by pharyngeal tissue up to half of stoma length. Metastegostom anisomorphic and most widened part of stoma, armed with three prominent setose denticles on each plate. Telostegostom heavily cuticularized. Pharynx well-developed, divided into 58–68  $\mu\text{m}$  long corpus, a well-developed, muscular, strongly swollen metacarpus of 18–28  $\times$  20–26  $\mu\text{m}$ ; a relatively narrower, 40–53  $\mu\text{m}$  long isthmus, and a well-developed basal bulb of 18–28  $\mu\text{m}$   $\times$  18–24  $\mu\text{m}$ , with a grinder and cuticularized double-chambered haustrulum. Cardia conoid, 5–7  $\mu\text{m}$  long. Nerve ring encircling anterior region of isthmus, just posterior to median bulb at 62.7–67.1% of pharyngeal length. Secretory-excretory pore located posterior to nerve ring, at mid-level of isthmus or at 79.6–82.8% of total pharyngeal length from anterior end. Intestine showing a bacterial pouch just posterior to pharyngo-intestinal junction. In some individuals, an intestinal diverticulum representing shifted bacterial pouch was observed. Rectum, 0.5–0.7 times anal body diameter. Tail cupola-shaped, ca 1.5–1.7 times as long as anal body diameter. Spike covering more than half of total tail length. Phasmids opening at level of anus.

### **Female**

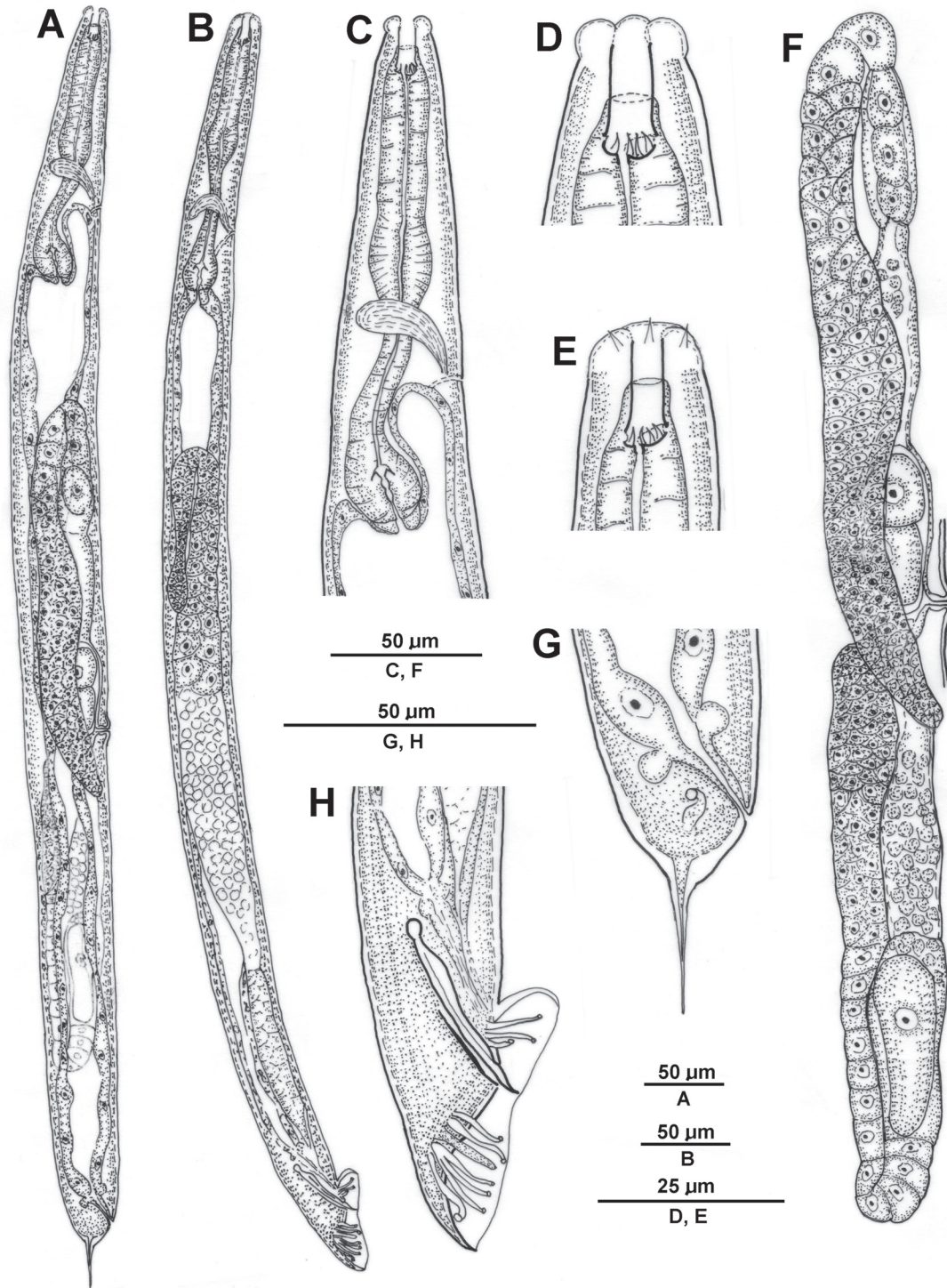
Reproductive system didelphic, amphidelphic, ovaries well-developed, opposed and dorsally reflexed, distal ends reaching up to vulva. A coelomocyte present close to distal tip of each ovary, while another found close to reflexed part. Oocytes with prominent nuclei arranged in multiple rows distally. Oviducts not distinctly separated. Spermathecae elongated, filled with sperm. Uteri spacious, accommodating two to ten eggs at a time. Vagina cuticularized, thick-walled. Vulva equatorial, a transverse slit, with lips not protruded. Lateral cuticular vulval flaps present.

### **Male**

Sexually dimorphic with lip region dome-shaped, continuous with body contour. Lips weak, amalgamated, without a discernible identity. Pharynx relatively weak with moderately swollen metacarpus. Anterior region of intestine showing a small bacterial pouch. Testis single, dorsally reflexed, on right lateral side of intestine. Spermatocytes arranged in multiple rows. Seminal vesicle filled with spermatocytes leading to vas deferens. A pair of well-developed ejaculatory glands present. A coelomocyte present close to distal end of testis while another found close to reflexed part. Tail conoid, ending in an acute terminus. Bursa well-developed, anteriorly closed, transversally and longitudinally striated with dot-like punctations. Bursal velum lobed with a shallow groove at cloaca. Anterior bursal rim distant from cloacal opening. Spicules almost straight, slender with rounded capitulum, narrow neck and shaft fused distally up to 12–14% of total length. Gubernaculum trough-shaped, ca 42.5–46.6% of spicule length. Genital papillae nine pairs, arranged in 3/2+Ph+3+1 configuration with pre cloacals GP1 and GP2 forming a group along with very short GP3, nearly half the length of others. GP1, GP4 and GP9 opening dorsally outside bursa; GP4, GP5 and phasmid forming a group; phasmids relatively shorter and thickened, located in between GP5 and group of GP6. GP6–8 basally fused, equal in shape and size. GP9 dorsally oriented.

### **Dauer/phoretic juvenile**

Body almost straight, abruptly tapering posterior to anus. Cuticle with fine transverse striations. Lateral field inconspicuous. Lip region continuous with amalgamated lips. Oral aperture covered with a cuticular plug. Stoma long, narrow, ca 5 times as long as wide. Metastegostomal swelling weakly developed, with faintly visible small denticles. Pharynx with a slender procorpus ca 40–52  $\mu\text{m}$  long, an

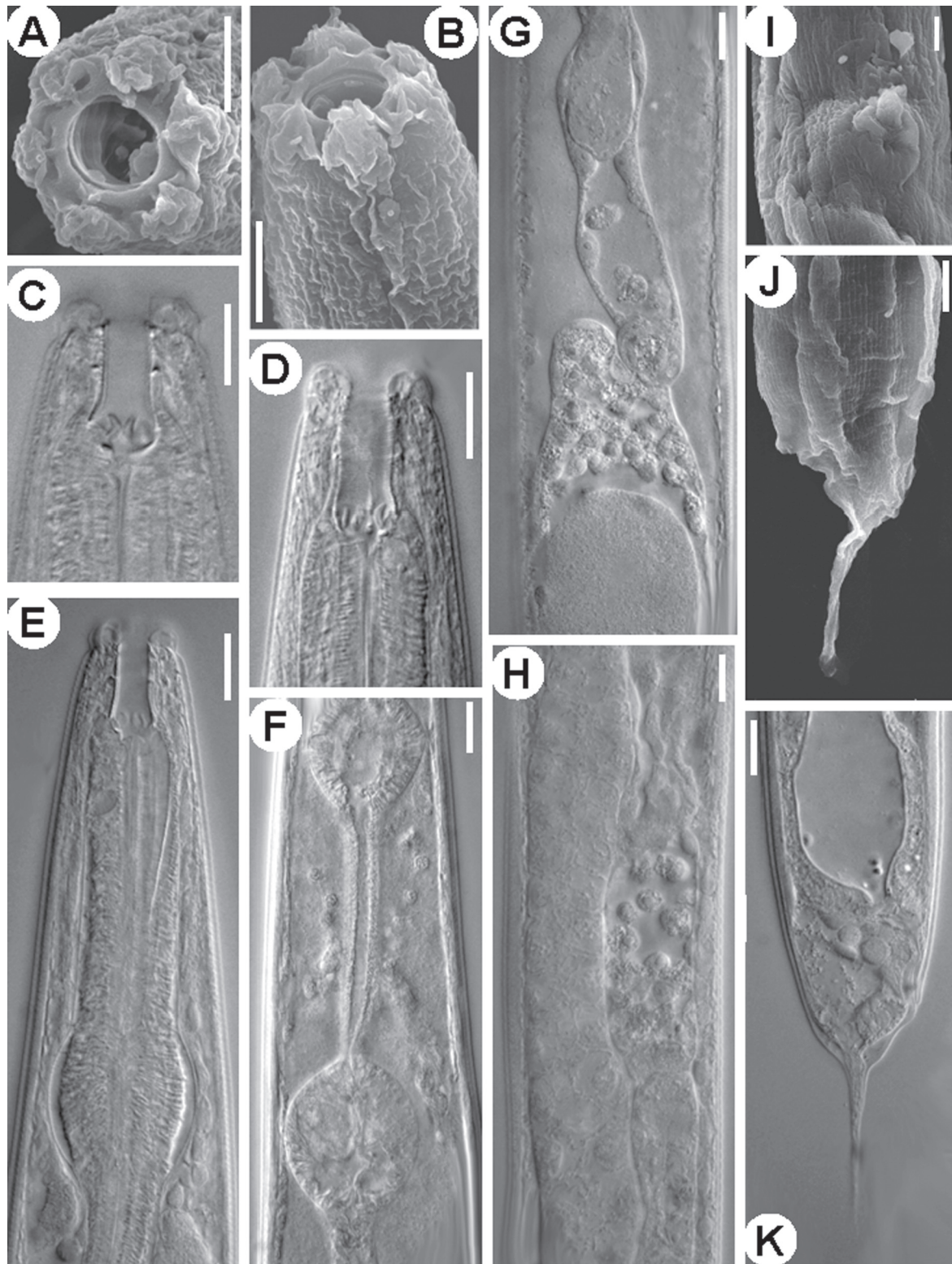


**Fig. 7.** *Pelodera paratretzeli* sp. nov., paratypes (AMU/ZD/NC slide no. *Pelodera paratretzeli* sp. nov./HS/AL/ST/BS/2–12). **A.** Entire female. **B.** Entire male. **C.** Female pharyngeal region. **D.** Female anterior end. **E.** Male anterior end. **F.** Female reproductive system. **G.** Female posterior region (lateral view). **H.** Male posterior region (lateral view).



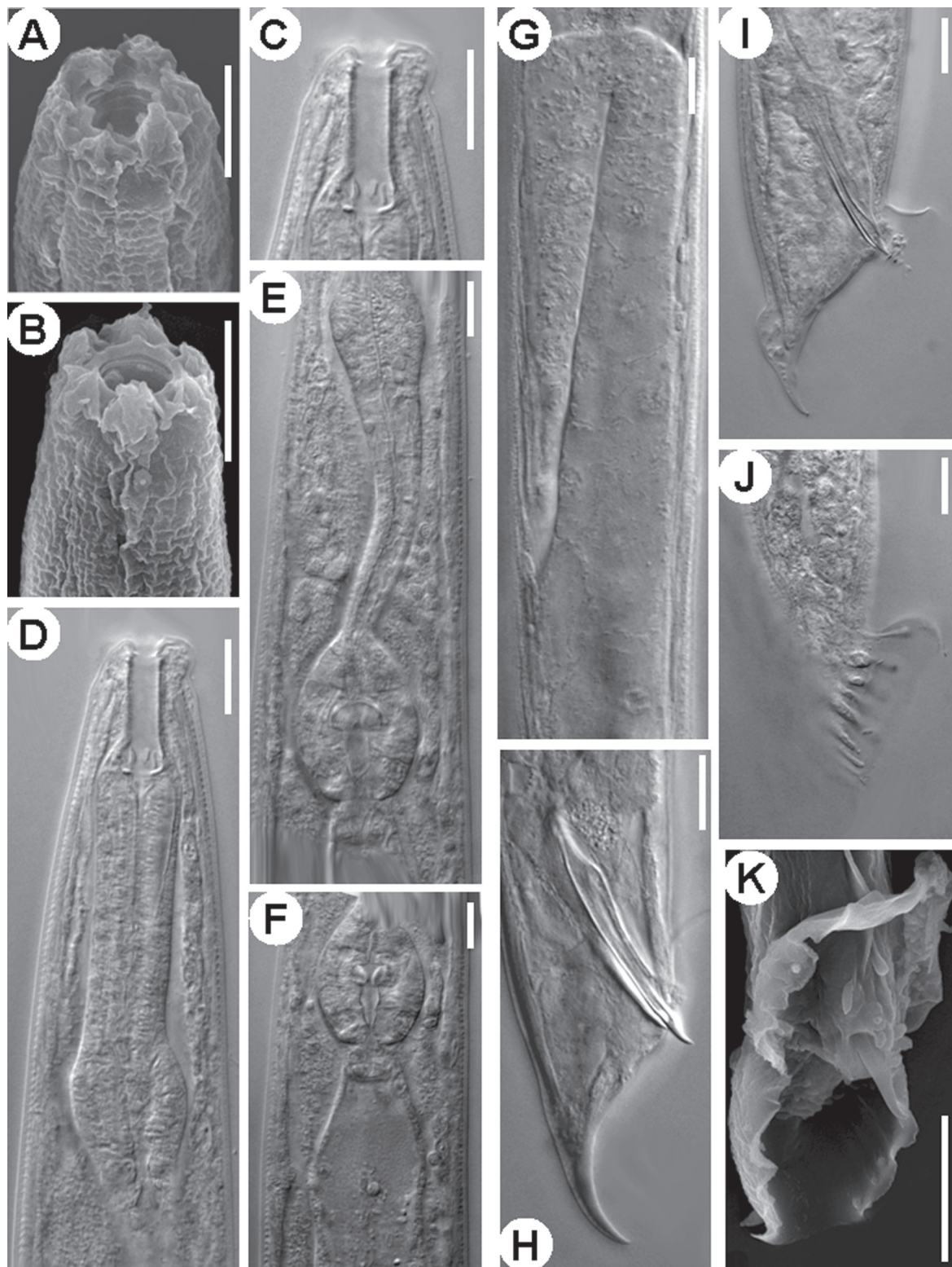
**Table 3.** Morphometric data of adult and dauer/phoretic juveniles of *Pelodera paratretzeli* sp. nov. Measurements are in  $\mu\text{m}$  and in the form: mean  $\pm$  standard deviation (range).

Character	Holotype ♀	Paratypes ♂♂	Paratypes ♀♀	Dauer/phoretic juveniles
n	–	(6 ♀♀)	(6 ♂♂)	(6 juvs)
Body length	795	796.5 $\pm$ 84.6 (644–866)	532.5 $\pm$ 54.3 (483–639)	482.7 $\pm$ 29.6 (439–507)
Body diam.	52	54.0 $\pm$ 12.7 (38–77)	29.7 $\pm$ 2.7 (26–34)	23.7 $\pm$ 0.5 (23–24)
a	15.3	15.1 $\pm$ 2.2 (11.1–17.3)	18.0 $\pm$ 1.3 (16.7–19.7)	17.1 $\pm$ 1.7 (14.5–18.4)
b	5.1	5.1 $\pm$ 0.3 (4.8–5.5)	4.0 $\pm$ 0.3 (3.7–4.6)	3.9 $\pm$ 0.1 (3.7–4.0)
c	15.9	19.1 $\pm$ 1.9 (15.9–21.5)	18.9 $\pm$ 1.6 (17.2–21.3)	7.0 $\pm$ 0.6 (6.5–8.0)
c'	2.0	1.7 $\pm$ 10.2 (1.5–2.0)	1.4 $\pm$ 0.1 (1.2–1.5)	3.7 $\pm$ 0.4 (3.1–4.3)
V/T	56.9	58.2 $\pm$ 2.7 (56.5–63.7)	66.2 $\pm$ 5.1 (59.4–73.6)	–
G1	53.5	52.5 $\pm$ 3.1 (47.4–56.2)	–	–
G2	49.1	49.7 $\pm$ 5.1 (42.7–57.8)	–	–
Lip region height	5	5.0 $\pm$ 0.6 (4–6)	–	3.0 $\pm$ 0.0 (3–3)
Lip region diam.	15	14.7 $\pm$ 1.0 (13–16)	11.8 $\pm$ 1.3 (10.0–14.0)	9.0 $\pm$ 0.0 (9–9)
Stoma length	20	19.8 $\pm$ 0.4 (19–20)	16.3.0 $\pm$ 0.8 (15–17)	17.5 $\pm$ 1.6 (15–19)
Stoma diam.	6	6.8 $\pm$ 1.2 (5–8)	5.3 $\pm$ 0.5 (5–6)	3.3 $\pm$ 0.5 (3–4)
Pharynx length	157	157.0 $\pm$ 13.7 (134–177)	132.3 $\pm$ 4.7 (127–139)	99.0 $\pm$ 8.0 (89–107)
Nerve ring from anterior end	105	99.5 $\pm$ 7.7 (90–111)	86.5 $\pm$ 6.8 (80–97)	71.0 $\pm$ 4.4 (65–75)
Secretory-excretory pore from anterior end	123	120.5 $\pm$ 11.0 (111–141)	105.8 $\pm$ 1.8 (103–108)	–
Rectum length	15	15.2 $\pm$ 0.4 (15–16)	31.2 $\pm$ 1.5 (30–33)	15.0 $\pm$ 0.6 (14–16)
Anal body diam.	25	24.8 $\pm$ 2.9 (20–29)	20.5 $\pm$ 0.8 (20–22)	17.0 $\pm$ 0.6 (16–18)
Vulva–Anus distance		290.2 $\pm$ 33.0 (240–325)	–	–
Egg length	55	55.3 $\pm$ 4.7 (45–65)	–	–
Egg diam.	38	38.2 $\pm$ 3.8 (35–45)	–	–
Spicule length	–	–	33.7 $\pm$ 3.5 (30–40)	–
Gubernaculum length	–	–	15.5 $\pm$ 1.0 (14–17)	–
Tail length	50	42.2 $\pm$ 6.8 (30–50)	28.2 $\pm$ 1.8 (26–30)	110.8 $\pm$ 3.2 (105–114)



**Fig. 8.** *Pelodera paratretzeli* sp. nov., paratype, ♀ (AMU/ZD/NC slide no. *Pelodera paratretzeli* sp. nov./HS/AL/ST/BS/2–12). **A.** En face view (scanning electron microscopy). **B.** Anterior region (scanning electron microscopy). **C–D.** Anterior end. **E.** Anterior pharyngeal region. **F.** Posterior pharyngeal region. **G–H.** Female genital branch. **I.** Vulval region (scanning electron microscopy). **J.** Tail region (scanning electron microscopy). **K.** Posterior region. Scale bars = 10 µm.





**Fig. 9.** *Pelodera paratretzeli* sp. nov., paratype, ♂ (AMU/ZD/NC slide no. *Pelodera paratretzeli* sp. nov./HS/AL/ST/BS/2–12). **A.** En face view (scanning electron microscopy). **B.** Anterior region (scanning electron microscopy). **C.** Anterior end. **D.** Anterior pharyngeal region. **E–F.** Posterior pharyngeal region. **G.** Reflexed testis. **H–J.** Posterior region (lateral view). **K.** Posterior region (scanning electron microscopy). Scale bars = 10  $\mu$ m.

oblong, ca 12–13  $\mu\text{m}$   $\times$  9–12  $\mu\text{m}$  metacarpus, a narrow, ca 22–32  $\mu\text{m}$  long isthmus and a pyriform, ca 14–17  $\mu\text{m}$   $\times$  10–14  $\mu\text{m}$  basal bulb, lacking valvular plate. Nerve ring encircling mid-region of isthmus. Secretory-excretory duct inconspicuous. Rectum faintly visible, ca equal to anal body diameter. Phasmidial aperture inconspicuous. Tail long, conoid, covered with hyaline sheath and ended with a sharp, pointed tip.

### Remarks

*Pelodera paratretzeli* sp. nov. comes close to *P. tretzeli* (Sachs, 1950) in most morphological characters but differs in females having small-sized body (644–866  $\mu\text{m}$  vs 1543–3327  $\mu\text{m}$ ); smaller b (4.8–5.5 vs 8.1–11.9) and c (15.9–21.5 vs 28.4–33.1) values; metastegostom anisomorphic (vs isomorphic); rectum 0.5–0.7 times (vs 0.3–0.4 times) anal body diameter; phasmids at level of anus (vs at base of wider part of tail); males with smaller body length (483–639  $\mu\text{m}$  vs 636–758  $\mu\text{m}$ ); smaller b (3.7–4.6 vs 4.9–5.9), c (17.2–21.3 vs 28.4–35.6) and greater c' (1.2–1.5 vs 0.7–0.8) values; spicules slender (vs slightly plump), having distinct neck (vs neck not demarcated); bursa with shallow groove (vs deep indentation) laterally at level of cloaca; genital papillae with slender bases (vs swollen bases in *P. tretzeli* fide Sachs (1950)).

***Pelodera cylindrica* (Cobb, 1898)**  
Figs 10–15; Tables 4–6; Appendices 1–2

*Rhabditis cylindrica* Cobb, 1898: 296–321.

*Rhabditis neuhausi* Sachs, 1950: 323–366, fig. 4.

*Coarctadera cylindrica* – Andrásy 1983: 113.

*Pelodera serrata* – Ali *et al.* 1973: 169–188 [not *P. serrata* (Körner in Osche, 1952)].

*Pelodera icosiensis* – Hussain *et al.* 2006: 55–62 [not *P. icosiensis* Maupas, 1916].

### Emended diagnosis

*Pelodera cylindrica* (Cobb, 1898) is characterized by an obese, stout and almost straight body, tapering at anterior region; sexual dimorphism present in anterior region; cuticle finely annulated; lip region strongly offset from body contour and dilated approximately twice of its height; lips with small labial sensilla; stoma ca 2.5–3.0 times as long as its height; metastegostom with three setose denticles on each sector; rectum shorter than anal body diameter; tail short, hemispheroid, shorter than anal body diameter, lacking spike, often with a small mammellate peg or protrusion terminally; spicules with rounded capitulum, short, narrow neck and slender shaft, fused distally up to 24–25% of spicule length; gubernaculum ca 44.0–47.5% of spicule length; bursa peloderan, anteriorly closed, punctated; bursal velum lobed with three deep grooves at GP2, GP3 and GP5; anterior bursal rim close to cloacal opening; genital papillae nine pairs, arranged in 0/1+1+1+1+1+P+3+1 configuration; pre cloacals shifted posterior to cloaca; GP1, GP4 and GP9 open dorsally outside the bursa; GP3–5 relatively close to each other, GP6–8 basally fused and phasmids shorter and thickened between GP5 and GP6.

### Material examined

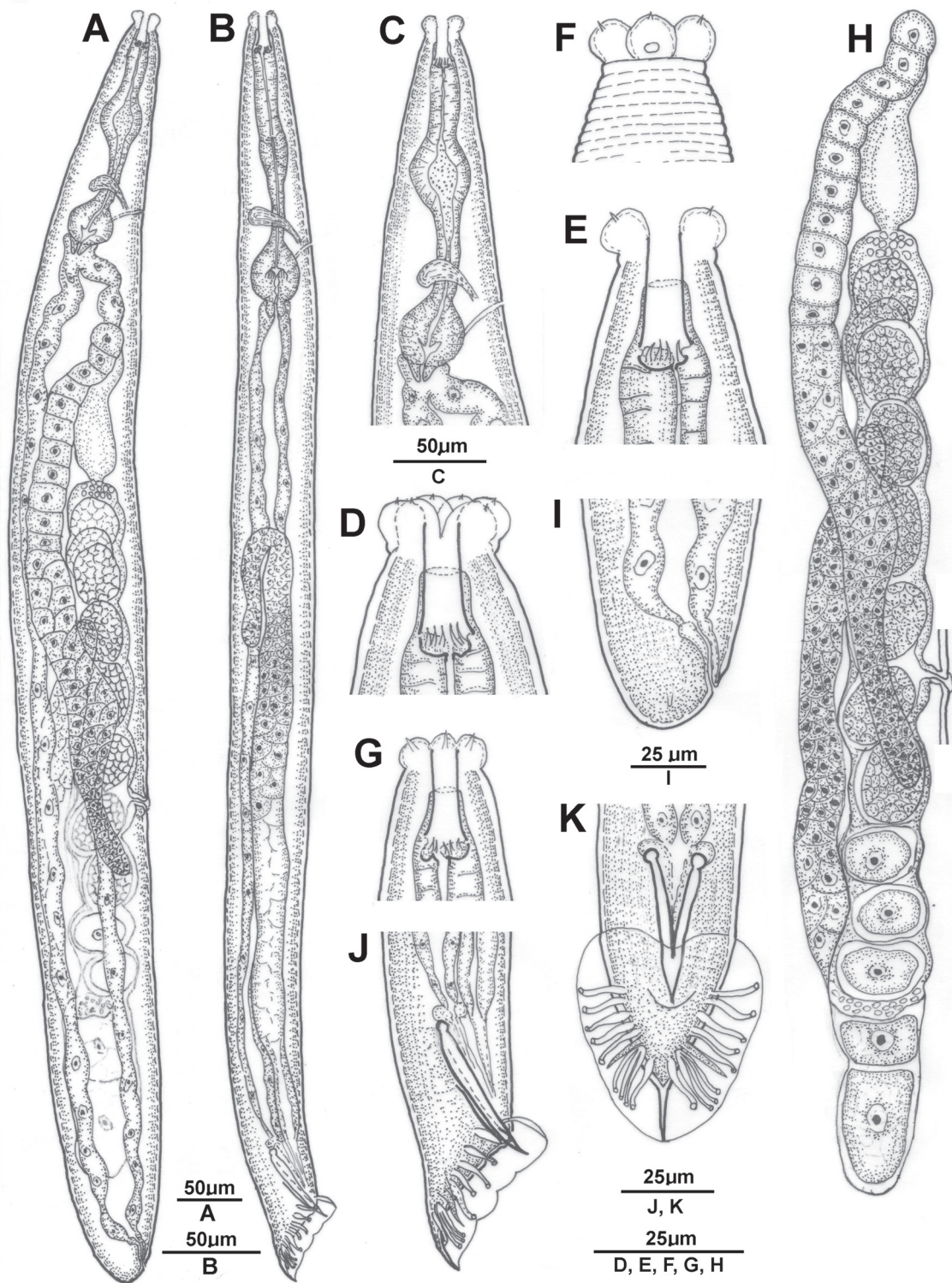
INDIA • 5 ♂♂, 5 ♀♀, 6 juvs; Uttar Pradesh, Aligarh, Satha; 27°58'52" N, 78°06'10" E; extracted from soil samples contaminated by the discharges of sugar industry; AMU/ZD/NC slide no. *Pelodera cylindrica*/HL/AL/ST/SM/1–10.

### Description

#### Adult

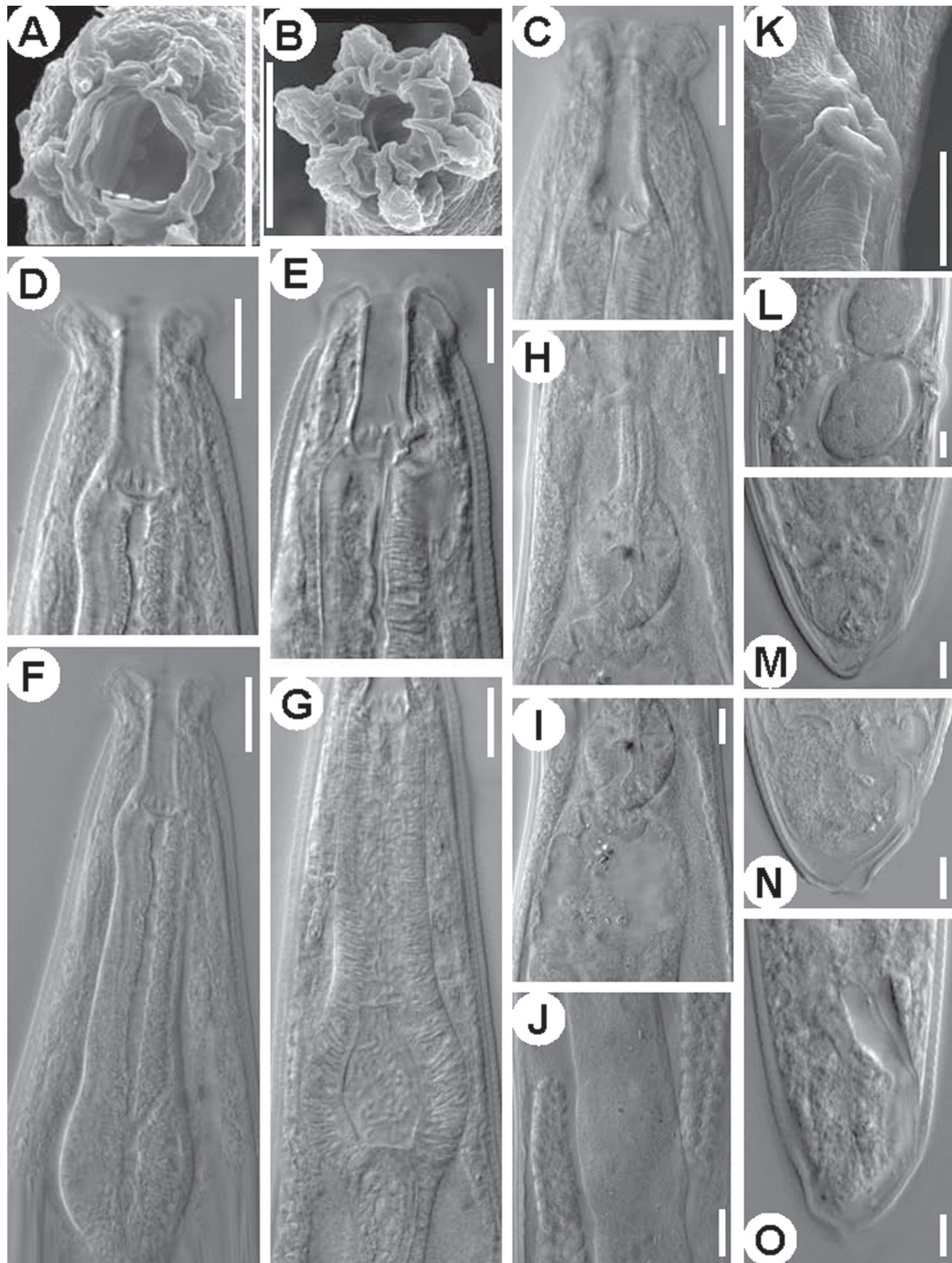
Body medium-sized, obese, stout, almost straight with tapering anterior region. Sexual dimorphism observed in anterior body region. Cuticle 1.0–1.5  $\mu\text{m}$  thick, transversely annulated, interspersed





**Fig. 10.** *Pelodera cylindrica* Cobb, 1898 (AMU/ZD/NC slide no. *Pelodera cylindrica*/HL/AL/ST/SM/1–10). **A.** Entire female. **B.** Entire male. **C–F.** Female anterior end. **G.** Male anterior end. **H.** Female reproductive system. **I.** Female tail (lateral view). **J.** Male tail (lateral view). **K.** Male tail (ventral view).

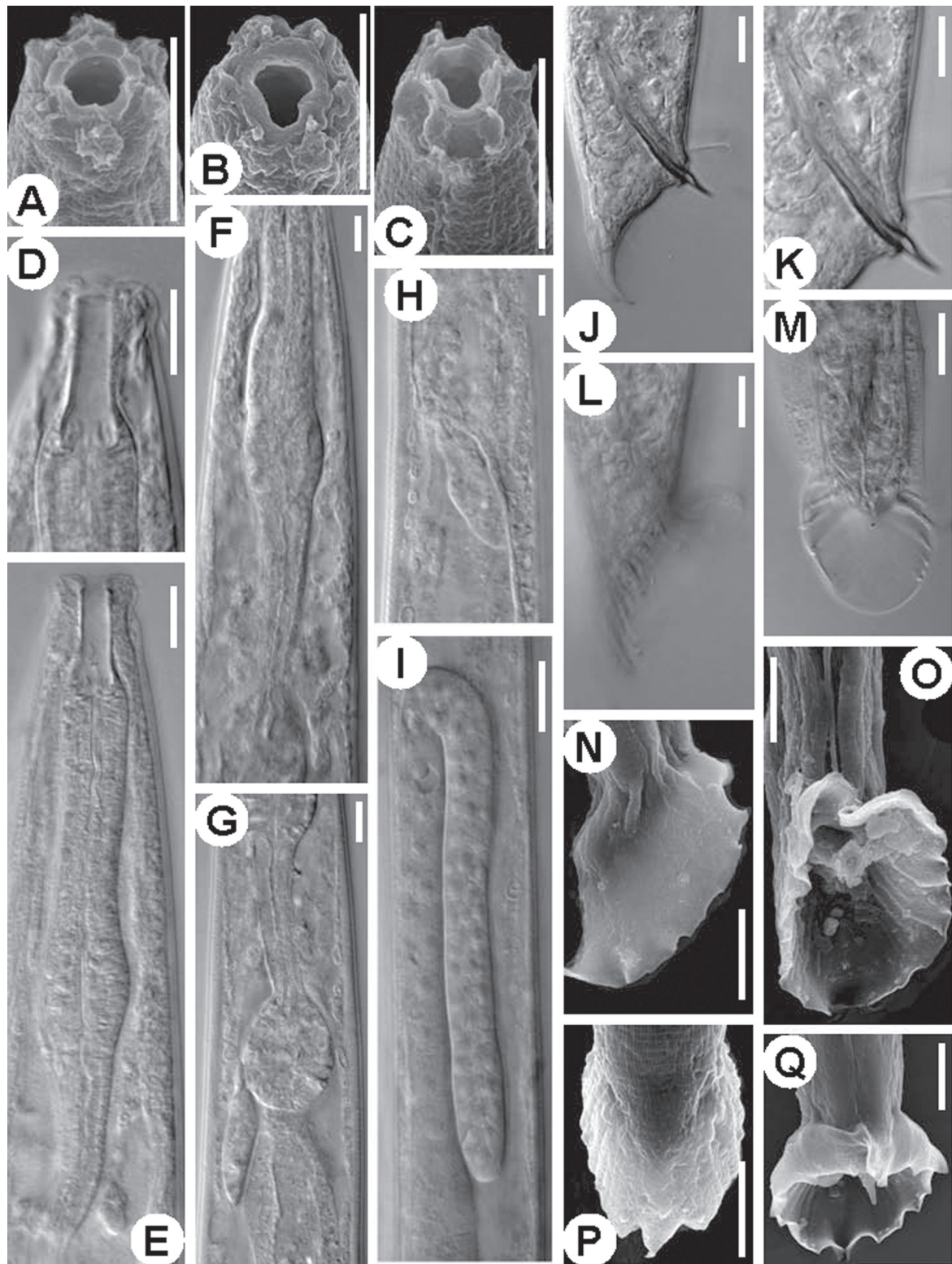




**Fig. 11.** *Pelodera cylindrica* Cobb, 1898, female (AMU/ZD/NC slide no. *Pelodera cylindrica*/HL/AL/ST/SM/1–10). **A–B.** En face view (scanning electron microscopy). **C–E.** Anterior end. **F–G.** Anterior pharyngeal region. **H–I.** Posterior pharyngeal region. **J.** Distal end of anterior and posterior genital branches. **K.** Vulval region (scanning electron microscopy). **L–O.** Tail end. Scale bars = 10  $\mu$ m.

**Table 4.** Morphometric data of adult and dauer/phoretic juveniles of *Pelodera cylindrica* (Cobb, 1898) Andrassy, 1972. Measurements are in  $\mu\text{m}$  and in the form: mean  $\pm$  standard deviation (range).

Character	Males	Females	Dauer/phoretic juveniles
n	(6 ♂♂)	(6 ♀♀)	(6 juvs)
Body length	698.7 $\pm$ 104.2 (589–847)	913.0 $\pm$ 112.9 (805–1123)	417.2 $\pm$ 35.6 (348–442)
Body diam.	47.3 $\pm$ 9.1 (40–64)	88.2 $\pm$ 23.4 (50–123)	24.5 $\pm$ 1.4 (23–27)
a	14.9 $\pm$ 1.0 (13.2–16.0)	10.9 $\pm$ 2.6 (9.0–16.1)	17.1 $\pm$ 1.7 (14.5–18.4)
b	4.7 $\pm$ 0.4 (4.4–5.2)	5.2 $\pm$ 0.5 (4.8–6.0)	3.9 $\pm$ 0.1 (3.7–4.0)
c	18.3 $\pm$ 1.6 (16.4–21.1)	51.2 $\pm$ 10.1 (37.5–65.4)	7.0 $\pm$ 0.6 (6.5–8.0)
c'	1.4 $\pm$ 0.1 (1.2–1.5)	0.6 $\pm$ 0.2 (0.4–0.8)	3.7 $\pm$ 0.4 (3.1–4.3)
V/T	65.4 $\pm$ 6.9 (54.5–74.9)	63.8 $\pm$ 3.3 (60.4–69.3)	–
G1	–	69.6 $\pm$ 19.7 (39.1–96.5)	–
G2	–	62.5 $\pm$ 15.7 (34.8–83.5)	–
Lip region height	6.0 $\pm$ 0.6 (5–7)	8.8 $\pm$ 1.3 (7–10)	3.5 $\pm$ 0.5 (3–4)
Lip region diam.	15.0 $\pm$ 1.5 (14.0–18.0)	20.8 $\pm$ 1.6 (18–22)	8.8 $\pm$ 0.4 (8–9)
Stoma length	21.3 $\pm$ 2.0 (20–25)	25.0 $\pm$ 2.0 (21–26)	15.8 $\pm$ 0.4 (15–16)
Stoma diam.	7.2 $\pm$ 0.4 (7–8)	8.8 $\pm$ 0.8 (8–10)	3.3 $\pm$ 0.5 (3–4)
Pharynx length	149.2 $\pm$ 16.8 (135–182)	174.5 $\pm$ 18.6 (138–188)	106.8 $\pm$ 7.3 (93–112)
Nerve ring from anterior end	104.3 $\pm$ 11.5 (95–127)	126.8 $\pm$ 18.4 (90–138)	71.2 $\pm$ 3.4 (65–75)
Secretory-excretory pore from anterior end	118.7 $\pm$ 11.6 (110–142)	137.0 $\pm$ 18.6 (100–148)	–
Rectum length	–	20.0 $\pm$ 4.2 (15–25)	20.0 $\pm$ 0.6 (19–21)
Anal body diam.	27.3 $\pm$ 2.1 (24–30)	32.0 $\pm$ 8.0 (23–45)	16.2 $\pm$ 1.7 (14–18)
Vulva–Anus distance	–	313.3 $\pm$ 60.9 (220–420)	–
Egg length	–	59.3 $\pm$ 7.1 (50–70)	–
Egg diam.	–	37.2 $\pm$ 3.5 (37–45)	–
Spicule length	44.5 $\pm$ 3.4 (40–50)	–	–
Gubernaculum length	20.2 $\pm$ 1.0 (19–22)	–	–
Tail length	38.2 $\pm$ 3.8 (35–45)	18.5 $\pm$ 4.6 (13–25)	59.5 $\pm$ 7.0 (50–68)



**Fig. 12.** *Pelodera cylindrica* Cobb, 1898, male (AMU/ZD/NC slide no. *Pelodera cylindrica*/HL/AL/ST/SM/1–10). A–C. En face view (scanning electron microscopy). D. Anterior end. E–F. Anterior pharyngeal region. G. Posterior pharyngeal region. H. Body region showing large excretory gland cell. I. Reflexed testis. J–L. Posterior region (lateral view). M. Posterior region (ventral view). N–Q. Posterior region (scanning electron microscopy). Scale bars = 10  $\mu$ m.



with longitudinal striations and punctation. Lip region dilated, strongly offset from body contour, approximately more than twice its height. Lips six, globular in shape, distinctly separated, with minute papilliform labial sensilla. Amphids labial with small, ovoid apertures. Stoma well-developed, expanding posteriorly, 2.5–3.0 times as long as wide or 13–15% of total pharyngeal length. Cheilostom not cuticularized. Gymnostom constituting 40–45% of stoma length. Stegostom surrounded by pharyngeal tissue, constituting 56–58% of stoma length; metastegostom wide, armed with three well-developed setose denticles on each sector. Telostegostom heavily cuticularized. Pharynx well-developed, divided into 55–77  $\mu\text{m}$  long, slender corpus, a well-developed, highly muscular, approximately 20–30  $\mu\text{m}$   $\times$  22–32  $\mu\text{m}$  metacarpus, a relatively narrower, 35–50  $\mu\text{m}$  long isthmus and a well-developed, rounded to oval-shaped basal bulb of 28–39  $\mu\text{m}$   $\times$  24–35  $\mu\text{m}$  having a highly cuticularized grinder with double-chambered haustrulum. Cardia conoid, 5–10  $\mu\text{m}$  long. Nerve ring usually encircling posterior region of isthmus at ca 65.2–73.4% of pharyngeal length. Secretory-excretory pore located posterior to nerve ring, or at 72.4–78.7% of total pharyngeal length. Bacterial chamber present posterior to pharyngo-intestinal junction. Rectum 0.5–0.6 times anal body diameter.

#### **Female**

Reproductive system didelphic, amphidelphic. Ovaries well-developed, paired, opposed, and dorsally reflexed, usually distal end extending beyond vulva. Oocytes with prominent nuclei arranged in multiple rows. Spermathecae ovoid filled with sperm. Uteri with 2–15 eggs ca 50–70  $\times$  37–45  $\mu\text{m}$  in dimension. Vulva without protruded lips, slightly post equatorial. Tail short, hemispheroid, often with a small peg or mammellate tip, shorter than anal body diameter. Phasmids opening slightly posterior to anus.

#### **Male**

Similar to female in general morphology except narrower lip region, smaller body size, smaller metastegostomal denticles and slight curvature in posterior region. Testis single, dorsally conoid, ending in a pointed terminus. Spicules almost straight, slender with rounded capitulum, narrow neck and slender shaft, fused distally up to 24–25% of total spicule length. Gubernaculum slender, trough-shaped, ca 44.0–47.5% of spicule length. Bursa well-developed, anteriorly closed, transversely and longitudinally striated with dot-like punctations. Bursal velum lobed, forming three deep grooves at GP1, GP2 and GP3. Anterior bursal rim close to cloacal opening. Nine pairs of genital papillae arranged in 0/1+1+1+1+1+P+3+1 configuration with pre-cloacal genital papillae GP1 and GP2 shifted posterior to cloaca. GP3–5 relatively closely placed. Phasmid relatively shorter and thickened, located in between GP5 and GP6. GP6–8 basally fused. GP1, GP4 and GP9 open dorsally outside bursa.

#### **Dauer/phoretic juvenile**

Body slightly arcuate ventrally, tapering at both extremities. Cuticle with fine transverse striations. Lateral field with a single ridge. Lip region continuous with six separated lips, each containing setose sensilla. Stoma long, narrow, ca 4–5 times as long as wide. Metastegostomal swelling with faintly visible small denticles. Pharynx well-developed with ca 40–43  $\mu\text{m}$ , long, slender procorpus, a highly muscular metacarpus 15–17  $\mu\text{m}$   $\times$  13–16  $\mu\text{m}$  in dimension, a narrow, ca 20–34  $\mu\text{m}$  long isthmus and a basal bulb ca 18–22  $\mu\text{m}$   $\times$  15–17  $\mu\text{m}$  in dimension, having a cuticularized grinder. Nerve ring encircling mid of isthmus. Secretory-excretory pore inconspicuous. Pre-rectum-like structure present in posterior region. Rectum ca equal to anal body diameter in length. Phasmidial aperture inconspicuous. Tail short and conoid.

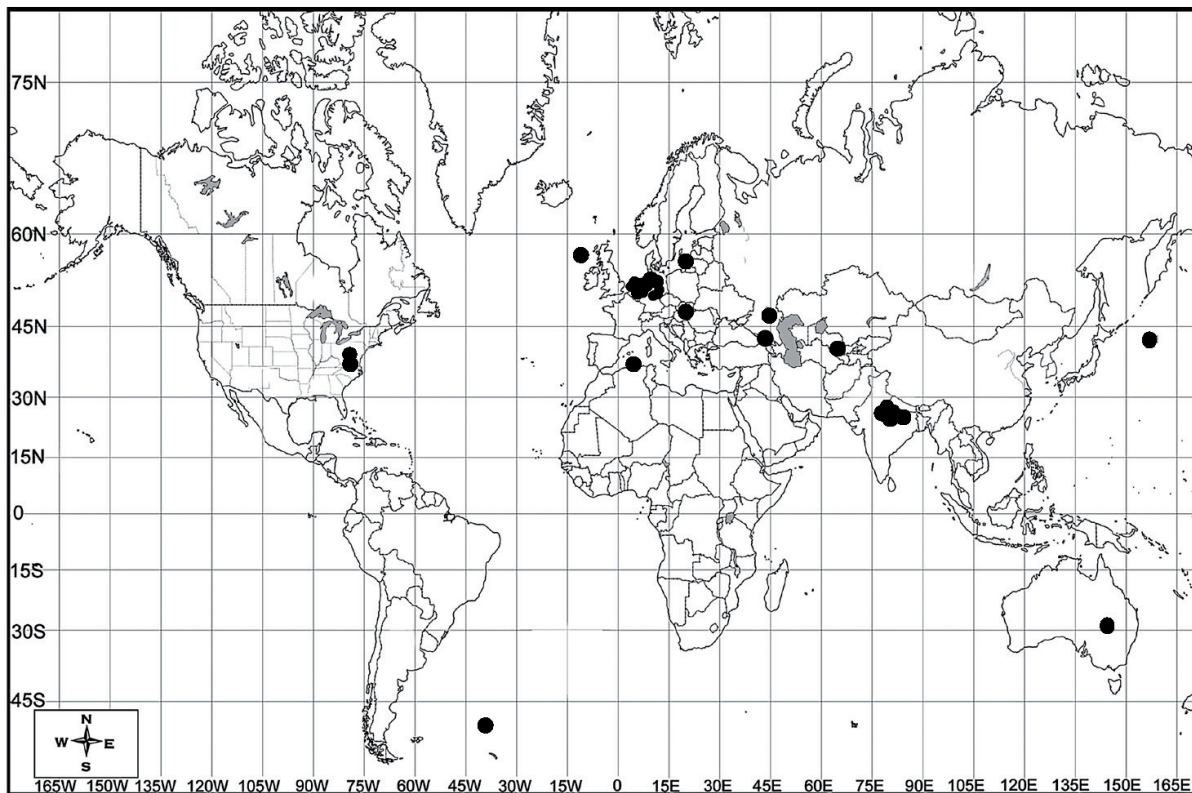
## Remarks

The present population showed conformity with *P. cylindrica* (Cobb, 1898) in most characteristics except a few minor differences from the originally described population viz., metastegostom with strongly developed (vs moderately developed) denticles and males with genital papillae GP1 and GP2 distant (vs closely placed). The females in the present population also show a small terminal peg or mammellate protrusion in the tail not reported in the original population.

## Discussion

### Geographical distribution of the genus *Pelodera*

*Pelodera* with 26 valid species is a widely distributed genus with species recorded from eleven countries (Fig. 13). However, most species (e.g., *P. nidicolis* Sudhaus & Schulte, 1986, *P. orbitalis* Sudhaus & Schulte, 1986, *P. strongyloides*, *P. teres* Schneider, 1866, *P. pseudoteres* Schulte, 1989, *P. coarctata*, *P. cystilarva*, *P. serrata*, *P. kolbi*, *P. trezeli* and *P. voelki*) have been described from Germany. The rest of the species viz., *P. punctata* and *P. parateres* (Cobb, 1924), *P. termitis* Carta *et al.*, 2010, *P. cylindrica*, *P. icosiensis*, *P. arnbomi* Bostrom, 1996, *P. par*, *P. cutanea* Sudhaus *et al.*, 1987 and *P. merionis* Sudhaus, 1991 were described from Australia, Algeria, Georgia, Hungary, United Kingdom, Lithuania, Russia and Uzbekistan respectively whereas *P. cylindrica*, *P. aligarhensis* (*coarctata* group), *P. pseudoteres* and *P. scrofulata* Tahseen *et al.*, 2014 were described from India.



**Fig. 13.** Map showing worldwide distribution of the species of genus *Pelodera* Schneider, 1866 (*coarctata* group) in countries like Algeria, Australia, Germany, Georgia, Hungary, India, Lithuania, Russia, United Kingdom, Uzbekistan, etc.

**Table 5** (continued on next three pages). Differentiating morphometric values of the species of *Pelodera* Schneider, 1866 (*coarctata* group).

Character	<i>P. adeeli</i> sp. nov.	<i>P. aligarhensis</i> Tahseen <i>et al.</i> , 2014	<i>P. coarctata</i> (Leuckart, 1891)	<i>P. cylindrica</i> (Cobb, 1898)	<i>P. cystilarva</i> (Völk, 1950)	<i>P. indica</i> sp. nov.	<i>P. isociensis</i> Maupas, 1916
	Females						
Body length	678–934	688–841	1202–1587	630–1985	1224–1744	849–1065	1214–1830
a	11.6–13.9	16.3–20.0	14.1–16.7	9.0–15.0	12.5–15.8	13.7–18.6	17–18
b	4.2–5.4	3.9–4.6	5.8–7.9	4.1–7.1	6.2–7.6	5.1–6.2	5.2–7.5
c	12.5–17.2	22.1–41.2	17.5–20.6	38.6–70.9	7.5–9.1	14.7–21.1	30.3–57.3
c'	1.7–2.1	0.8–1.4	1.6–1.9	0.5–0.6	2.6–6.7	1.1–1.8	–
V	57.7–60.0	61.6–63.5	57.5–58.6	58–69	49.4–52.4	55.5–63.2	56.2–61.2
Lip height	8–9	7–9	5.7	7.1–7.6	15	5–8	–
Lip diam.	19–22	15–18	20	16.0–24.9	32.5	16–19	–
Stoma length	21–23	24–25	30	21–30	52.5	24–29	28
Stoma diam.	4–5	5–5	5.7	5.5–7.6	7.5	6–8	–
Stoma %	13.1–13.4	13.4–13.8	14.4–15.0	10.7–20.1	22.8–27.3	15.5–16.5	11.5–12.2
Pharynx length	160–171	173–186	200–207	141–279	192–230	154–175	228–243
Pharynx %	18.3–23.5	22.1–25.1	13.0–16.6	14.0–16.5	13.1–15.5	16.4–18.0	13.2–18.7
Basal bulb length	27–32	27–33	–	28–40	51.9	26–31	–
Basal bulb diam.	24–26	22–25	–	21–34	36.3	25–28	–
Pharyngeal sleeve	12–13	–	10	10.0–17.2	25	11–13	–
Anal body diam.	25–31	19–25	40.5	19–50	41.5	32–42	–
Rectum length	24–28	16–22	45	9.5–19.2	–	20–26	–
Rectum/anal body diam.	0.9–0.9	0.8–0.9	1.1	0.4–0.5	–	0.6–0.6	–
Tail length	50–64	20–31	68.6–77.0	11.0–31.2	108–281	41–62	32–40
Spike length	–	5.9	54.5	–	81–208	20–31	20
Spike length vs tail length %	–	19.0–29.5	70.7–79.4	–	74–75	48.7–50.0	50.0–62.5



**Table 5** (continued). Differentiating morphometric values of the species of *Pelodera* Schneider, 1866 (*coarctata* group).

Character	<i>P. adeeli</i> sp. nov.	<i>P. aligarhensis</i> Tahseen <i>et al.</i> , 2014	<i>P. coarctata</i> (Leuckart, 1891)	<i>P. cylindrica</i> (Cobb, 1898)	<i>P. cystilarva</i> (Völkl, 1950)	<i>P. indica</i> sp. nov.	<i>P. isociensis</i> Maupas, 1916
Males							
Body length	577-722	526-608	918-1069	450-1050	880-1072	591-727	705-1345
a	13.4-16.8	17.5-18.4	14.1-20.9	9.0-17.8	11.5-12.0	15.4-22.0	14.5-17.5
b	4.0-4.8	3.8-4.4	4.3-5.5	3.2-5.7	5.0-5.4	4.1-5.3	4.7-6.2
c	15.6-19.4	16.2-24.3	27.1-36.8	12.5-33.4	26.1-46.3	13.8-18.1	14.5-19.6
c'	1.2-1.6	1.0-1.8	0.5	1.2-1.7	1.0-2.2	1.4-1.7	-
Pharynx length	139-149	119-155	194-213	129-162	162-216	137-154	157-217
Pharynx %	20.6-24.0	22.6-25.4	19.9-21.1	15.4-28.6	12.3-13.2	21.1-23.1	16.1-22.2
Spicule length	37-50	30-38	68-97	32-50	32-70	45-47	39-54
Spicule distally fused	9-10	6.0-9.5	20	10-20	8	13-16	10
Gubernaculum length	9-11	15-18	27-33	12-20	27-70	17-24	18-24
Gubernaculum %	22.0-24.3	40-45	34.0-39.7	37.5-40.0	84.3-100.0	37.7-51.0	42.8
Anal body diam.	25-30	18-27	50	23.0-37.1	40	24-29	31.3
Rectum length	30-40	20-33	-	9.5	-	35-50	-
Tail length	37-40	25-37	29.8-33.8	23.5-45.0	41-89	40-46	48.6-68.6

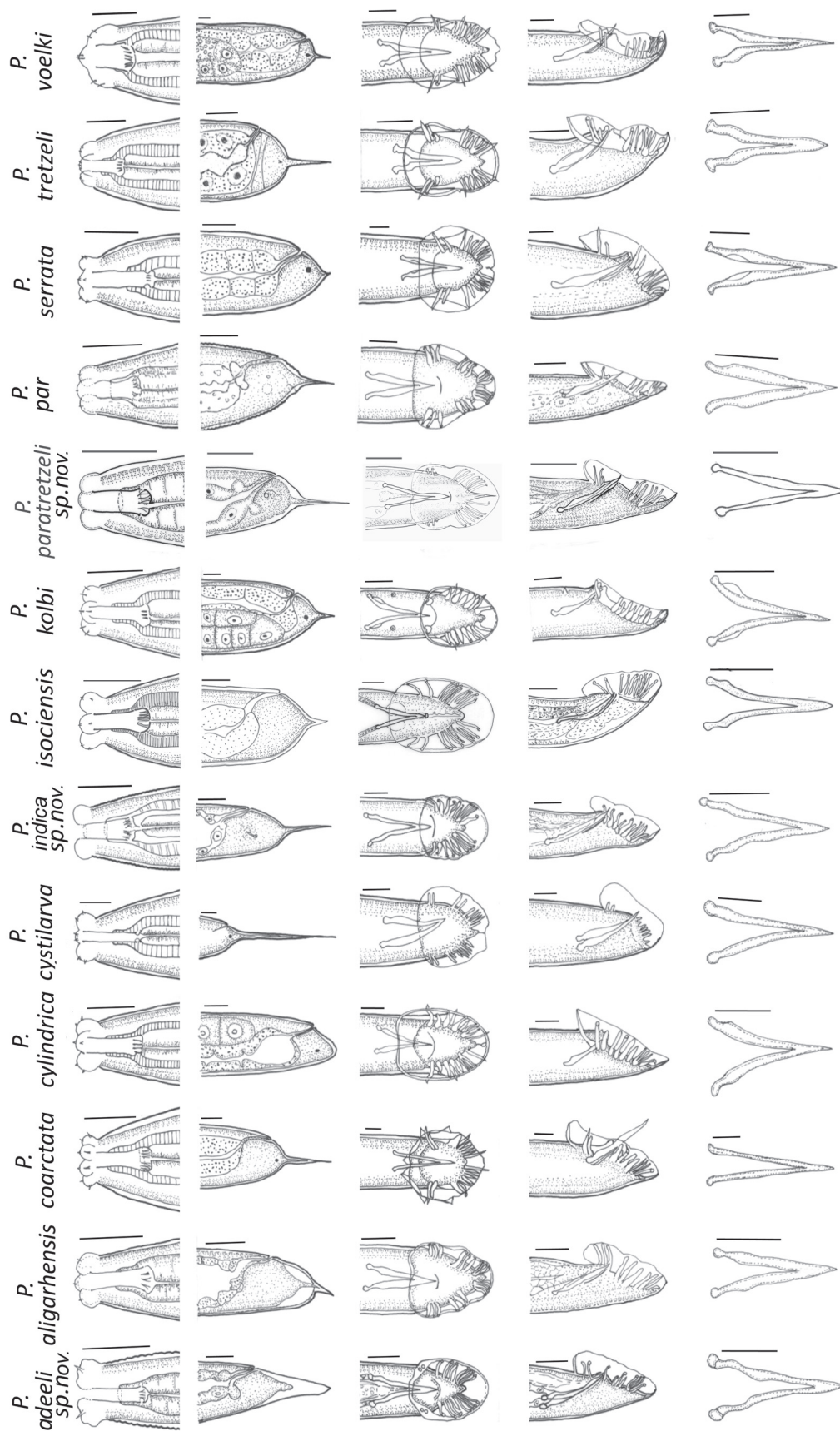
Table 5 (continued). Differentiating morphometric values of the species of *Pelodera* Schneider, 1866 (*coarctata* group).

Character	<i>P. kolbi</i> (Sachs, 1950)	<i>P. par</i> (Andrassy, 1962)	<i>P. pararetzeli</i> sp. nov.	<i>P. serrata</i> (Körner, 1952)	<i>P. tretzeli</i> (Sachs, 1950)	<i>P. voelki</i> (Sachs, 1950)
Females						
Body length	1185–1326	1060	644–866	1148–1409	1543–3327	1470–3610
a	12.8–15.9	18.5	11.1–17.3	11.2–13.2	12.1–17.3	15.1–18.1
b	5.9–7.9	7.1	4.8–5.5	4.6–5.9	8.1–11.9	7.6–9.6
c	21.9–27.9	27.5	15.9–21.5	37.0–50.7	28.4–33.1	25.8–36.3
c'	0.9–1.0	1.5	1.5–2.0	1.0–1.2	1.2–2.4	1.3–2.4
V	56.2–57.7	58.9	56.5–63.7	56.9–60.9	57.1–58.8	59.0–60.0
Lip height	5.9	4.7	4–6	7.1	6.7	9.7
Lip diam.	15.6	11.7	13–16	17.1	20.2	22.2
Stoma length	23.4	21	19–20	32.6	23.0	26.2
Stoma diam.	4.2	4.7	5–8	7.1	5.4	9.6
Stoma %	11.4–13.7	14.0	11.2–14.1	13.0–13.6	8.2–12.1	6.9–13.5
Pharynx length	168–201	149	134–177	238–249	190–279	193–37
Pharynx %	14.1–15.1	14.0	20.4–20.8	17.6–20.7	8.3–12.3	10.4–13.1
Basal bulb length	31.1	–	18–28	39.9	32.0	45.4
Basal bulb diam.	31.1	20	18–24	28.5	28.5	40.9
Pharyngeal sleeve	10.1	12.6	–	19.8	10.8	15.2
Anal body diam.	50.0	25.6	20–29	25.6	40.9	40.9
Rectum length	–	25.6	15–16	–	–	–
Rectum/anal body diam.	–	1–1	0.5–0.7	–	–	–

**Table 5** (continued). Differentiating morphometric values of the species of *Pelodera* Schneider, 1866 (*coarctata* group).

Character	<i>P. kolbi</i> (Sachs, 1950)	<i>P. par</i> (Andrassy, 1962)	<i>P. paratretzeli</i> sp. nov.	<i>P. serrata</i> (Körner, 1952)	<i>P. tretzeli</i> (Sachs, 1950)	<i>P. voelki</i> (Sachs, 1950)
Tail length	47.5–54.1	38.5	30–50	27.7–31.0	53–100	56.9–99.4
Spike length	14.8	13.7	20–31	2.8	29.5	22.7
Spike length vs tail length %	27.3–31.1	35.5	62.0–66.6	9.0–10.1	29.5–55.6	22.8–39.8
Males						
Body length	715–812	660	483–639	1067–1242	636–758	885–1625
a	16.1–18.1	22.7	16.7–19.7	12.9–15.7	15.4–17.6	16.3–20.0
b	4.4–6.7	4.3	3.7–4.6	4.8–5.9	4.9–5.9	5.3–6.1
c	15.9–19.9	21.0	17.2–21.3	29.3–41.0	28.4–35.6	21.6–26.7
c'	1.5	1.7	1.2–1.5	–	0.7–0.8	1.1
Pharynx length	121–162	153	127–139	210–222	128–130	166–266
Pharynx %	16.9–19.9	23.1	21.7–26.2	17.8–19.6	17.1–20.1	16.3–18.7
Spicule length	35–47	42	30–40	68–80	32–39	51–70
Spicule distally fused %	9	10	5–6	18	10	18
Gubermaculum length	17–22	21	14–17	31–35	14–19	20–36
Gubermaculum %	46.8–48.5	50	42.5–46.6	43.7–45.5	43.7–48.7	39.2–51.4
Anal body diam.	38.9	19.6	20–22	–	28.3	35.6
Rectum length	–	39.2	30–33	–	–	–
Tail length	59.5	35	26–30	30.2–36.4	21.2–22.3	40.9–60.8





**Fig. 14.** Pictorial key for the comparison of the species of genus *Pelodera* Schneider, 1866 (*coarctata* group) based on the female anterior region, tail region, male tail region (lateral and ventral views) and spicules (distally fused). Scale bars = 20  $\mu$ m.

**Table 6** (continued on next page). Differentiating morphological characters of the species of *Pelodera* Schneider, 1866 (*coarctata* group).

Character	<i>P. adzeeli</i> sp. nov.	<i>P. aligarhensis</i> Tahseen <i>et al.</i> , 2014	<i>P. coarctata</i> Leuckart, 1891	<i>P. cylindrica</i> Cobb, 1898	<i>P. cystilarva</i> Völk, 1950	<i>P. icosiensis</i> Maupas, 1916	<i>P. indica</i> sp. nov.
Sexual dimorphism	absent	present	present	present	present	–	present
Lip region diam. vs height	≈ 2 times	≈ 2 times	≈ 3 times	≈ 2–3 times	≈ 2 times	–	≈ 2–3 times
Stoma length vs diam.	≈ 5 times longer	5 times longer	≈ 5 times longer	≈ 4 times longer	7 times longer	–	≈ 4 times longer
Metacarpal swelling	present	present	present	present	present	present	present
Tail length	moderate-long	small	long	small	long	moderate	moderate-long
Tail shape	conoid	cupola-shaped	cupola-shaped	hemispheroid	cupola-shaped	cupola-shaped	cupola-shaped
Spike length	–	minute	moderate	–	long	small	small
Spike length vs tail length	–	< 1/2	> 1/2	–	> 1/2	1/2 or > 1/2	1/2
Spicules distally fused	20–24%	20–25%	20–29%	31–40%	11–25%	31–40%	28–34%
Gubernaculum length vs spicule length	< 1/2	< 1/2	< 1/2	< 1/2	≈ equal	< 1/2	≤ 1/2
Bursal margins	lobed	lobed	lobed	lobed	lobed	–	lobed
Bursal velum	punctated	punctated	not punctated	punctated	not punctated	punctated	punctated
Ant. bursal velum from cloaca	distant	close	distant	close	distant	distant	close
Pre-cloacal genital papillae	2	3	2	0	2	2	0
Post-cloacal genital papillae	7	6	7	9	7	7	9
GP1	inside bursa	inside bursa	inside bursa	inside bursa	inside bursa	inside bursa	inside bursa
GP2	inside bursa	inside bursa	inside bursa	inside bursa	inside bursa	inside bursa	inside bursa
GP3	slender	slender	plump	slender	plump	slender	slender
GP5	plump	plump	slender	plump	slender	plump	plump
Phasmids	shorter, plump	shorter, plump	shorter, plump	shorter, plump	shorter, slender	shorter, plump	shorter, plump
GP6–8	basally fused	basally fused	basally fused	basally fused	basally fused	basally fused	basally fused
Bases of GP	normal	normal	swollen	swollen	normal	normal	swollen

**Table 6** (continued). Differentiating morphological characters of the species of *Pelodera* Schneider, 1866 (*coarctata* group).

Character	<i>P. kolbi</i> Sachs, 1950	<i>P. paratretzeli</i> sp. nov.	<i>P. par</i> Andrássy, 1962	<i>P. serrata</i> Körner, 1954	<i>R. stammeri</i> Völk, 1950	<i>P. tretzeli</i> Sachs, 1950	<i>P. voelki</i> Sachs, 1950
Sexual dimorphism	present	present	absent	present	?	present	present
Lip region diam. vs height	≈ 2 times	≈ 3 times	≈ 2 times	≈ 2 times	?	≈ 3 times	≈ 2 times
Stoma length vs diam.	≈ 5 times longer	2–4 times longer	≈ 4 times longer	> 4 times longer	2 times longer	3 times longer	< 3 times longer
Metacarpal swelling	present	present	present	present	absent	present	present
Tail length	moderate-long	moderate	moderate	≈ small	moderate	long	long
Tail shape	cupola-shaped	cupola-shaped	cupola-shaped	cupola-shaped	hemispheroid	cupola-shaped	cupola-shaped
Spike length	small	small	small	minute	–	small	small
Spike length vs tail length	< 1/2	> 1/2	< 1/2	< 1/2	–	1/2 or < 1/2	< 1/2
Spicules distally fused	18–25%	12–14%	23%	22–26%	–	25–31%	25–35%
Gubernaculum length vs spicule length	< 1/2	< 1/2	1/2	< 1/2	> 1/2	< 1/2	≤ 1/2
Bursal margins	smooth	lobed	smooth	smooth	smooth	lobed	lobed
Bursal velum	not punctated	punctated	punctated	punctated	?	punctated	punctated
Ant. bursal velum from cloaca	close	distant	close	distant	–	distant	distant
Pre-cloacal genital papillae	2	3	3	2	3	3	2
Post-cloacal genital papillae	7	6	6	7	6	6	7
GP1	outside bursa	inside bursa	inside bursa	inside bursa	outside bursa	inside bursa	inside bursa
GP2	inside bursa	inside bursa	inside bursa	inside bursa	outside bursa	inside bursa	inside bursa
GP3	slender	slender	slender	plump	?	slender	slender
GP5	plump	plump	plump	slender	?	plump	plump
Phasmids	shorter, plump	shorter, plump	shorter, plump	shorter, slender	?	shorter, plump	shorter, plump
GP6–8	basally not fused	basally fused	basally fused	basally fused	not fused	basally fused	basally fused
Bases of GP	swollen	normal	normal	normal	normal	swollen	normal



### Habitat preferences

The species of *Pelodera* have been predominantly reported from dung or droppings of mammals, organic matter, sewage, compost, decaying substances, as well as from the nest of rodents. However, 30% of species were reported to be associated with insects (Mahboob & Tahseen 2021). Phoresis has largely been demonstrated by the species of the *coarctata* group viz., dauer juveniles of *P. coarctata*, *P. serrata* and *P. icosiensis* form cysts while being associated with insects, whereas *P. cystilarva* has been found associated with mites.

### Entomophilic nature of nematodes

The species of the *coarctata* group are gonochoristic with a sex ratio of nearly 1:1. The females are prolific reproducers with large ovaries having distal ends often crossing each other. The females tend to be ovoviviparous, thus holding a good number of intra-uterine eggs in different stages of embryonation. Such increased reproductive capacity with hundreds of offspring is also an adaptation of saprobiontic nematodes of ephemeral habitats (Sudhaus 1976; Nicholas 1984). As a survival strategy, not to exploit the resources to the exhaustion level, most of the species of the *coarctata* group seem to behave like fugitive species and complete only one generation in the substrate by forming development-arrested dauer juveniles which wait for a biovehicle, especially insect, to get transported to a new habitat (Sachs 1950; Sudhaus 1981). The dauer larva is an evolutionarily advanced stage which can also be referred to as the phoretic or infective stage. Enclosed (ensheathed) in the cuticle of the preceding J2-stage, the dauer larva is a non-feeding, resistant third stage juvenile with a closed stoma, thus thriving on its stored fat deposits. Conspicuous phasmids with associated gland cells may have some role in detecting cues to use as behaviour-regulating signals prompting the dauer larvae to embark upon an insect in search for a favourable substratum to continue their development (Sachs 1950; Völk 1950; Körner 1954; Rühm 1956; Sudhaus 1976, etc.). The three species viz., *P. coarctata*, *P. cystilarva* and *P. serrata*, demonstrate more advanced strategies by producing larvae with a sculptured cuticle and form cyst-like dauer larvae which adhere to the legs of dung beetles through some secretions in order to reach a new habitat (Sudhaus 1976).

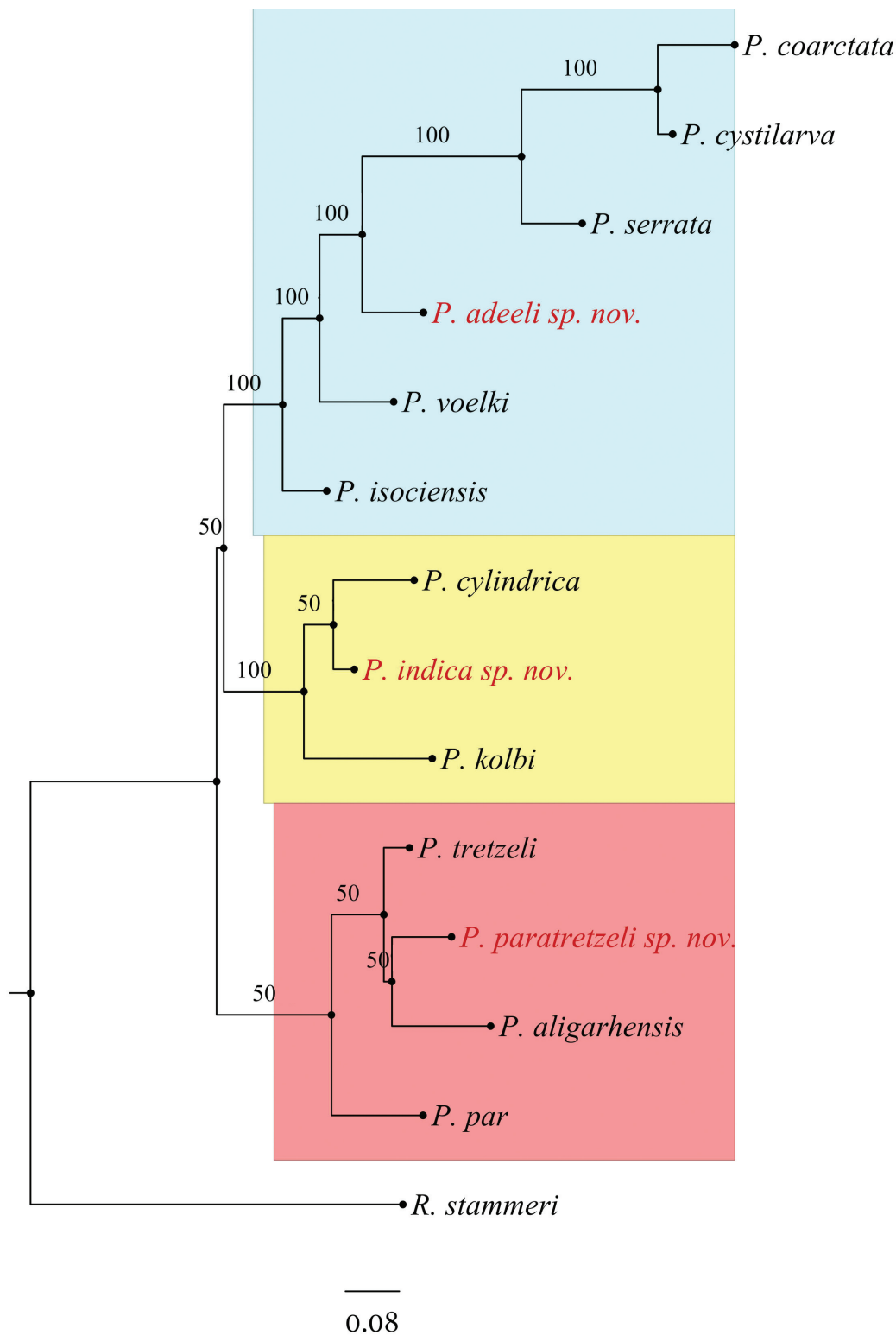
### Salient features of the representatives

The species of the genus *Pelodera* are mainly characterised by their medium- to large-sized body, females with equatorial vulva, amphidelphic gonad with long ovaries and a cupola-shaped tail while males have conspicuous ejaculatory glands and relatively long spicules having proximal offset heads and fused distal ends. Besides these primary plesiomorphic characters, some additional characters are the globular lips with minute to moderately-developed labial sensilla, offset lip region, well developed glottoid apparatus, basal bulb with double haustulum, and nine pairs of genital papillae with plump phasmids located between GP5 and GP6.

The division of the genus into three groups, the *coarctata*, *teres* and *strongyloides* groups, by Sudhaus & Fitch (2001), is appropriate due to their marked morphological differences. The *coarctata* group is differentiated from the rest of the groups largely by sexual dimorphism in the anterior region (except *P. adeeli* sp. nov.), with females having an expanded and strongly offset lip region, while males have relatively less prominent or amalgamated lips and a continuous lip region, and the presence of an anteriorly closed bursa, metastegostom widened at base, with strongly developed thorn-shaped teeth and telostegostom thickly cuticularized. The *teres* group is characterised by an open bursa and three pairs of precloacal papillae in males, whereas the species of the *strongyloides* group have spicules distally fused up to 50% or more of their length and two pairs of precloacal papillae. The pharyngeal sleeve is absent in the latter but present in the other two groups.

### Cladistic analysis and relationship of the congeners of the *coarctata* group

In the *coarctata* group, a wide metastegostom with setose denticles, conspicuous pharyngeal sleeve, and genital papillae bursal (situated within the bursa) are plesiomorphic characters found in all representative



**Fig. 15.** Cladistic analysis of the species of genus *Pelodera* Schneider, 1866 (*coarctata* group) indicating the position of the new species *P. indica* sp. nov., *P. adeeli* sp. nov. and *P. paratretzeli* sp. nov. within the genus. The evolutionary history was inferred in MrBayes ver. 3.1.2 (Huelsenbeck & Ronquist 2001) by using the Jukes Cantor (JC) model. The phylogenetic tree is supported by posterior probability values with minimum 50% majority rules.

species. However, *P. kolbi* shows an exception with the prebursal position of GP1. The cladogram (Fig. 15) constructed based on high weight morphological characters (Appendix 1) shows a remarkable similarity with the cladistic diagram presented by Sudhaus & Fitch (2001). *Rhomborhabditis stammeri* (Völk, 1950), the outgroup, although aberrant in various respects, shows some ancestral affiliations with *Pelodera* viz., metastegostom with setose denticles, short, plump, hemispheroid tail in females, males with conspicuous ejaculatory glands, peloderan bursa and fused spicules. Some of the diverging features include a continuous lip region, glottoid apparatus inconspicuous, pharyngeal sleeve very short and pharynx without a metacarpal swelling.

The tree topology falls into two categories, presumably on the basis of the position of GP3, with three main clusters: *P. tretzeli*, *P. paratretzeli* sp. nov., *P. aligarhensis* and *P. par* split in a separate group with 50% branch support value based on the presence of three pairs precloacal genital papillae, while the congeners with two precloacal genital papillae (*P. coarctata*, *P. cystilarva*, *P. serrata*, *P. adeeli*, *P. voelki*, and *P. isociensis*) form a separate cluster and another group representing *P. cylindrica* and *P. indica* sp. nov. shows precloacals shifted posterior to the cloacal opening. *Pelodera kolbi* with *P. cylindrica*, and *P. indica* sp. nov. also demonstrates similarity in having compactly arranged genital papillae without marked space in between; however, the rest of the species demonstrate a conspicuous diastema between the last precloacal pair and the first postcloacal pair. *Pelodera kolbi* is distinct from the others in not having genital papillae 1, 4 and 9 opening dorsally outside the bursa and the group of GP6–8 basally fused as described by Sudhaus and Fitch (2001). The position of *P. kolbi* is debatable and needs a revision in the future.

The close position of *P. coarctata*, *P. cystilarva* and *P. serrata* in the constructed tree (Fig. 15) is presumably due to a conspicuously thicker GP3 and the dauer larvae with a strongly sculptured cuticle, forming a cyst and anchoring to transporting animals (insects) with their anterior ends. The three species also show a wide, sucker-shaped, laterally expanded fan-like, non-punctuated bursa. *Pelodera adeeli* sp. nov. diverges in a separate branch because of paedomorphic, conoid tail, lacking a spike and having a different arrangement of genital papillae. *Pelodera voelki* and *P. isociensis* fall next in line and show similarity on account of the cupola-shaped tail with very small spike, GP3 shifted posteriorly to be close to GP4 while GP5 lies close to the group of GP6–8. *Pelodera indica* sp. nov. groups with *P. cylindrica* perhaps due to similarity in having compactly arranged genital papillae, with GP1 and GP2 placed posteriad to the cloacal level, and GP2 and GP3 spaced. The species appearing closer but occupying separate branches in the tree are *P. tretzeli*, *P. paratretzeli* sp. nov., *P. aligarhensis*, and *P. par* that share some common characters viz., three precloacal genital papillae, a wide gap between GP3 and GP4 and a prominently punctated bursa. *Pelodera paratretzeli* sp. nov. and *P. tretzeli* show similarity in many aspects except a few allometric values. *Pelodera par* appears more distinct from *P. aligarhensis*, *P. tretzeli* and *P. paratretzeli* in exhibiting no sexual dimorphism in the anterior region and a smooth bursal velum without any lobe. Another common feature possessed by these species is the shape of the bursa, which gets narrower at the cloacal opening. *Pelodera adeeli* sp. nov., on the other hand, is the only species which shows GP3 filling up the gap being equally spaced between GP2 (precloacal pair) and GP4 (postcloacal pair). The paedomorphic conoid tail, lacking a spike, is an apomorphic trait within the *coarctata* group; even the loss of the spike of the cupola-shaped tail in *P. cylindrica* also indicates apomorphy which was further verified by the presence of a peg-like or mammellate terminal protrusion in the tail of the present population of *P. cylindrica*, showing the reminiscence of the spike. The spike of the cupola has been lost independently in *R. stammeri* (Sudhaus & Fitch 2001). Lacking sexual dimorphism in the anterior region is apomorphic as well as a synapomorphic character because *P. par* also exhibits no sexual dimorphism in the anterior region, as also the present population of *P. cylindrica*. This may indicate that sexual dimorphism appeared at different levels in the evolutionary history of the ‘*coarctata*’ group.



## Acknowledgments

The authors gratefully acknowledge the Science and Engineering Research Board (SERB), Department of Science and Technology, Government of India, New Delhi, India, for providing financial support.

## References

- Ali M., Wahab A. & El-Kifel A.H. 1974. Nematodes associated with Coleoptera species in Egypt. II. *Parasitologia Hungarica* 6: 169–188.
- Andrássy I. 1962. Neue Nematoden-Arten aus Ungarn. 1. Zehn neue Arten der Unterklasse Secernentea (Phasmidia). *Acta Zoologica Academiae Scientiarum Hungaricae* 8: 1–23.
- Andrássy I. 1983. *A Taxonomic Review of the Suborder Rhabditina (Nematoda: Secernentea)*. ORSTOM, Paris.
- Andrássy I. 1984. *Klasse Nematoda (Ordnungen Monhysterida, Desmoscolecida, Araeolaimida, Chromadorida, Rhabditida)*. Gustav Fischer Verlag, Stuttgart. <https://doi.org/10.1515/9783112484586>
- Artigas P. 1927. Nematodeos de invertebrados. V. *Cruznema cruznema* novo genero e nova especie. *Boletim biológico Laboratório de Parasitologia Faculdade de Medicina de São Paulo* 10: 209–211.
- Baermann G. 1917. Eine einfache Methode zur Auffindung von Ankylostomum (Nematoden) Larven in Erdproben. *Geneeskundig Tijdschrift voor Nederlandsch-Indië* 57: 131–137.
- Boström S. 1996. One new and two known nematode species from the Subantarctic islands, South Georgia and East Falkland Island. *Fundamental and Applied Nematology* 19: 151–158.
- Carta L.K., Handoo Z.A., Lebedeva N.I., Raina A.K., Zhuginisov T.I. & Khamraev A.S. 2010. *Pelodera termitis* sp. nov. and two other rhabditid nematode species associated with the Turkestan termite *Anacanthotermes turkestanicus* from Uzbekistan. *International Journal of Nematology* 20: 125–134.
- Chitwood B.G. 1933. A revised classification of the Nematoda. *Journal of Parasitology* 20: 131.
- Cobb N.A. 1898. Extract from MS report on the parasites of stock. *Agricultural Gazette of New South Wales* 9: 296–321.
- Cobb N.A. 1918. Estimating the nema population of the soil. *Agricultural Technical Circular of US Department of Agriculture* 1: 1–48.
- Cobb N.A. 1924. Food of rhabdites and their relatives, with descriptions of two new rhabdites and a new rhabditoid genus. *Journal of Parasitology* 11: 116–117.
- De Ley P. & Blaxter M.L. 2002. Systematic position and phylogeny. In: Lee D.L. (ed.) *The Biology of Nematodes*: 1–30. Taylor & Francis, London. <https://doi.org/10.1201/b12614-1>
- De Maeseneer J. & D’Herde J. 1963. Méthodes utilisées pour l’étude des anguillules libres du sol. *Revue de l’Agriculture, Bruxelles* 16: 441–447.
- Dougherty E.C. 1953. The genera of the subfamily Rhabditinae Micoletzky, 1922 (Nematoda). In: Dayal J. & Singh K.S. (eds) *Thapar Commemoration Volume: A Collection of Articles Presented to Prof. G.S. Thapar on his 60<sup>th</sup> Birthday, 1953*: 69–76. University of Lucknow, Lucknow, India.
- Dujardin F. 1844/45. *Histoire naturelle des Helminthes ou Vers intestinaux*. Librairie encyclopédique de Roret, Paris. <https://doi.org/10.5962/bhl.title.10123>
- Fabricius J.C. 1775. *Systema entomologiae, sistens insectorum Classes, Ordines, Genera, Species, adjectis Synonymis, Locis, Descriptionibus, Observationibus*. Kortii, Flensburgi et Lipsiae [Flensburg and Leipzig]. <https://doi.org/10.5962/bhl.title.36510>
- Huelsenbeck J.P. & Ronquist F. 2001. MRBAYES: Bayesian inference of phylogenetic trees. *Bioinformatics* 17: 754–755. <https://doi.org/10.1093/bioinformatics/17.8.754>

- Hussain A., Tahseen Q. & Khan R. 2006. Redescription of two species of *Pelodera* (Nematoda: Rhabditidae) from India. *Nematologia Mediterranea* 34: 55–62.
- Inglis W.G. 1983. An outline classification of the Phylum Nematoda. *Australian Journal of Zoology* 31: 243–255. <https://doi.org/10.1071/ZO9830243>
- Körner H. 1954. Die Nematodenfauna des vergehenden Holzes und ihre Beziehungen zu den Insekten. *Zoologische Jahrbücher. Abteilung für Systematik, Ökologie und Geographie der Tiere* 82: 245–353.
- Larget B. & Simon D.L. 1999. Markov chain Monte Carlo algorithms for the Bayesian analysis of phylogenetic trees. *Molecular Biology and Evolution* 16: 750–759. <https://doi.org/10.1093/oxfordjournals.molbev.a026160>
- Leuckart K.G.F.R. 1891. Über einen an *Aphodius fimetarius* sich verpuppenden freilebenden Rundwurm, *Rhabditis coarctata* n. sp. *Verhandlungen der deutschen zoologischen Gesellschaft* 1: 54–56. Available from <https://www.biodiversitylibrary.org/page/47314665> [accessed 22 Jun. 2023].
- Linnaeus C. 1758. *Systema Naturae, sive regna tria naturae, secundum classes, ordines, genera, species, cum characteribus, differentiis, synonymis, locis*. Ed. 10<sup>a</sup>. Laurentii Salvii, Holmiae [Stockholm]. <https://doi.org/10.5962/bhl.title.542>
- Mahboob M. & Tahseen Q. 2021. Diversity, prevalence and microhabitat specificity of nematodes (Rhabditidae Örley, 1880 and Diplogastridae Micoletzky, 1922) associated with insects: an overview. *International Journal of Pest Management*: e1969470. <https://doi.org/10.1080/09670874.2021.1969470>
- Mahboob M., Chavan S.N., Nazir N., Mustaqim M., Jahan R. & Tahseen Q. 2021. Description of a new and two known species of the insect associated genus *Oigolaimella* Paramonov, 1952 (Nematoda: Diplogastridae) with a note on the biology, biogeography and relationship with congeners. *Zoologischer Anzeiger* 295: 163–190. <https://doi.org/10.1016/j.jcz.2021.09.007>
- Maupas E.F. 1916. Nouveaux *Rhabditis* d'Algérie. *Comptes rendus des Séances de la Société de Biologie et de ses Filiales* 79: 607–613.
- Nicholas W.L. 1984. *The Biology of Free-Living Nematodes*. 2<sup>nd</sup> Ed. Clarendon Press, Oxford.
- Örley L. 1880. Az anguillulidák magánrajza [Monographie der Anguilluliden]. *Természetrizsi Füzetek* 4: 16–150. Available from <https://www.biodiversitylibrary.org/page/31131071> [accessed 22 Jun. 23].
- Osche G. 1952. Systematik und Phylogenie der Gattung *Rhabditis* (Nematoda). *Zoologische Jahrbücher. Abteilung für Systematik, Ökologie und Geographie der Tiere* 81: 190–280.
- Potts F.A. 1932. The phylum Nematoda. In: Borradaile L.A., Eastham L.E.S., Potts F.A. & Saunders J.T. (eds) *The Invertebrata. A Manual for the Use of Students*: 214–227. Macmillan, Cambridge and New York.
- Rambaut A. 2012. Figtree v 1.4.0. Available from <http://tree.bio.ed.ac.uk/software/figtree/> [accessed 22 Jun. 203].
- Rühm W. 1956. Die Nematoden der Ipiden. *Parasitologische Schriftenreihe* 6: 1–437.
- Sachs H. 1950. Die Nematodenfauna der Rinderexkrementen. Eine ökologisch-systematische Studie. *Zoologische Jahrbücher. Abteilung für Systematik, Ökologie und Geographie der Tiere* 78: 323–366.
- Schneider A.F. 1860. Über die Muskeln und Nerven der Nematoden. *Archiv für Anatomie, Physiologie und wissenschaftliche Medizin* 1860: 224–242. Available from <https://www.biodiversitylibrary.org/page/14274435> [accessed 22 Jun. 2023].
- Schneider A.F. 1866. *Monographie der Nematoden*. G. Reimer, Berlin. <https://doi.org/10.5962/bhl.title.1938>

- Schulte F. 1989. Description of *Rhabditis (Pelodera) pseudoteres* n. sp. (Rhabditidae: Nematoda) with a redescription of its sibling *R. (P.) teres* (Schneider, 1866). *Revue de Nématologie* 12: 387–394.
- Seinhorst J.W. 1959. A rapid method for the transfer of nematodes from fixative to anhydrous glycerine. *Nematologica* 4: 67–69. <https://doi.org/10.1163/187529259X00381>
- Sudhaus W. 1976. Vergleichende Untersuchungen zur Phylogenie, Systematik, Ökologie, Biologie und Ethologie der Rhabditidae (Nematoda). *Zoologica* 43: 1–229.
- Sudhaus W. 1981. Über die Sukzession von Nematoden in Kuhfladen. *Pedobiologia* 21: 271–297. [https://doi.org/10.1016/S0031-4056\(23\)03592-8](https://doi.org/10.1016/S0031-4056(23)03592-8)
- Sudhaus W. 1991. Check list of species of *Rhabditis* sensu lato (Nematoda: Rhabditidae) discovered between 1976 and 1986. *Nematologica* 37: 229–236. <https://doi.org/10.1163/187529291X00213>
- Sudhaus W. 2011. Phylogenetic systematisation and catalogue of paraphyletic “Rhabditidae” (Secernentea, Nematoda). *Journal of Nematode Morphology and Systematics* 14: 113–178.
- Sudhaus W. & Fitch D. 2001. Comparative studies on the phylogeny and systematics of the Rhabditidae (Nematoda). *Journal of Nematology* 33: 1–70.
- Sudhaus W. & Schulte F. 1986. Auflösung des Artenkomplexes *Rhabditis (Pelodera)* “*strongyloides*” (Nematoda) und Beschreibung zweier neuer kryptischer Arten mit Bindung an Nagetiere. *Zoologische Jahrbücher. Abteilung für Systematik, Ökologie und Geographie der Tiere* 113: 409–428.
- Sudhaus W., Schulte F. & Hominick W.M. 1987. A further sibling species of *Rhabditis (Pelodera) strongyloides* (Nematoda): *Rhabditis (P.) cutanea* n. sp. from the skin of wood mice (*Apodemus sylvaticus*). *Revue de Nématologie* 10: 319–326.
- Tahseen Q., Akram M., Mustaqim M. & Ahlawat S. 2014. Descriptions of *Pelodera scrofulata* sp. nov. and *Pelodera aligarhensis* sp. nov. (Nematode: Rhabditida) with supplementary information on *Pelodera teres* (Schneider, 1866). *Journal of Natural History* 48 (17–18): 1027–1053. <https://doi.org/10.1080/00222933.2013.856491>
- Völk J. 1950. Die Nematoden der Regenwürmer und aabesuchenden Käfer. *Zoologische Jahrbücher. Abteilung für Systematik, Ökologie und Geographie der Tiere* 79: 1–70.
- Wiedemann C.R.W. 1823. Zweihundert neue Käfer von Java, Bengalen, und dem Vorgebirge der guten Hoffnung. *Zoologisches Magazin Kiel* 2: 3–133.  
Available from <https://www.biodiversitylibrary.org/page/14928530> [accessed 22 Jun. 2023].

*Manuscript received: 26 November 2021*

*Manuscript accepted: 10 March 2023*

*Published on: 25 August 2023*

*Topic editor: Jean-Lou Justine*

*Desk editor: Pepe Fernández*

Printed versions of all papers are also deposited in the libraries of the institutes that are members of the *EJT* consortium: Muséum national d’histoire naturelle, Paris, France; Meise Botanic Garden, Belgium; Royal Museum for Central Africa, Tervuren, Belgium; Royal Belgian Institute of Natural Sciences, Brussels, Belgium; Natural History Museum of Denmark, Copenhagen, Denmark; Naturalis Biodiversity Center, Leiden, the Netherlands; Museo Nacional de Ciencias Naturales-CSIC, Madrid, Spain; Leibniz Institute for the Analysis of Biodiversity Change, Bonn – Hamburg, Germany; National Museum of the Czech Republic, Prague, Czech Republic.



**Appendix 1.** Characters and character states for the comparison of species of *Pelodera* Schneider, 1866 (*coarctata* group).

No.	Characters	character states
1	Sexual dimorphism	present (0), absent (1)
2	Lip region	offset (0), not offset (1)
3	Stoma	wide [2–4 times longer ] (0), narrow [5–7 times longer ] (1)
4	Glottoid apparatus	distinguishable (0), indistinguishable (1)
5	Tail length	long [above 50 µm] (0), moderate [31–50 µm] (1), small [10–30 µm] (2)
6	Tail shape	cupola-shaped (0), hemispheroid (1), conoid (2)
7	Spike length	small [11–30 µm] (0), absent (1), minute [2–10 µm] (2), moderate [31–50 µm] (3), long [above 50 µm] (4)
8	Spicule length	up to 50 µm (0), more than 50 µm (1)
9	Spicules distally fused	more than 20% (0), less than 20% (1)
10	Gubernaculum length vs spicule length	≤ ½ of spicule length (0), > ½ or equal to spicule length (1)
11	Bursa	closed (0), open (1)
12	Punctations on bursa	present (0), absent (1)
13	Position of anterior bursal velum	close to cloaca (0), distant from cloaca (1)
14	Bases of genital papillae	normal (0), swollen (1)
15	No. of precloacal GP	two pairs (0), three pairs (1), absent (2), single pair (3)
16	Position of GP1	inside the bursa (0), outside the bursa (1)
17	Position of GP3	close to GP4 (0), distant from GP4 (1)
18	GP3	slender (0), plump (1)
19	GP5	plump, long (0), slender, long (1)
20	Group of GP6–8	basally fused (0), not fused (1)
21	Dauer cuticle	not-sculptured (0), sculptured (1)
22	Dauer forms cyst	no (0), yes (1)

Appendix 2. Data matrix for cluster analysis of the species in the genus *Pelodera* Schneider, 1866.

Character	1	2	3	4	5	6	7	8	9	10	11	12	13	14	15	16	17	18	19	20	21	22
<i>R. stammeri</i>	?	1	0	1	1	1	1	1	0	1	1	?	?	0	1	1	1	?	?	1	?	?
<i>P. coarctata</i>	0	0	1	0	0	0	3	1	0	0	0	1	1	1	0	0	0	1	1	0	0	1
<i>P. cylindrica</i>	0	0	0	0	2	1	1	0	0	0	0	0	0	1	2	0	0	0	0	0	1	0
<i>P. cystilarva</i>	0	0	1	0	0	0	4	1	0	1	0	1	1	0	0	0	0	1	1	0	0	1
<i>P. serrata</i>	0	0	0	0	2	0	2	1	0	0	0	1	0	0	0	0	0	1	1	0	0	1
<i>P. voelki</i>	0	0	0	0	0	0	0	1	0	0	0	1	0	0	0	0	0	0	0	0	1	0
<i>P. kolbi</i>	0	0	1	0	1	0	0	0	0	0	0	1	0	1	3	1	0	0	0	1	1	0
<i>P. isociensis</i>	0	0	?	0	1	0	0	0	0	0	0	1	0	0	0	0	0	0	0	0	1	0
<i>P. tretzeli</i>	0	0	0	0	0	0	0	0	0	0	0	0	0	1	1	0	1	0	0	0	1	0
<i>P. paratretzeli</i> sp. nov.	0	0	0	0	0	0	0	0	1	0	0	0	0	0	1	0	1	0	0	0	1	0
<i>P. par</i>	1	0	0	0	1	0	0	0	0	0	0	0	0	0	1	0	1	0	0	0	1	0
<i>P. aligariensis</i>	0	0	1	0	2	0	2	0	0	0	0	0	0	0	1	0	1	0	0	0	1	0
<i>P. indica</i> sp. nov.	0	0	0	0	0	0	0	0	0	0	0	0	0	1	2	0	0	0	0	0	1	0
<i>P. adeeli</i> sp. nov.	1	0	1	0	0	2	1	0	0	0	0	1	0	0	0	0	0	0	0	0	1	0