

Participles, gerunds and syntactic categories

John Lowe 

University of Oxford

Proceedings of the Joint 2016 Conference on Head-driven Phrase Structure
Grammar and Lexical Functional Grammar

Polish Academy of Sciences, Warsaw, Poland

Doug Arnold, Miriam Butt, Berthold Crysmann, Tracy Holloway King, Stefan
Müller (Editors)

2016

Stanford, CA: CSLI Publications

pages 401–421

Keywords: mixed categories, English gerund, participles, morphology

Lowe, John. 2016. Participles, gerunds and syntactic categories. In Doug Arnold, Miriam Butt, Berthold Crysmann, Tracy Holloway King & Stefan Müller (eds.), *Proceedings of the Joint 2016 Conference on Head-driven Phrase Structure Grammar and Lexical Functional Grammar, Polish Academy of Sciences, Warsaw, Poland*, 401–421. Stanford, CA: CSLI Publications. DOI: 10.21248/hpsg.2016.21. 

Abstract

The phenomenon of so-called ‘mixed’ categories, whereby a word heads a phrase which appears to display some features of one lexical category, and some features of another, raises questions regarding the criteria used for distinguishing syntactic categories. In this paper I critically assess some recent work in LFG which provides ‘mixed category’ analyses. I show that three types of evidence are typically utilized in analyses of supposed mixed category phenomena, and I argue that two of these are not, in fact, crucial for determining category status. I show that two distinct phenomena have become conflated under the ‘mixed category’ heading, and argue that the term ‘mixed category’ should be reserved for only one of these.

1 Mixed categories

So-called ‘mixed’ categories have been the subject of a number of works within LFG, in particular by Bresnan (1997, 2001, 289–296) and Bresnan et al. (2016, 309–319), Spencer (2004), Bresnan & Mugane (2006), Seiss (2008), Nikitina (2008), and Alsharif (2014). Most recently, Nikitina & Haug (2016), Spencer (2015) and Börjars et al. (2015) have discussed phenomena which they analyse in terms of mixed categories.

The most commonly discussed mixed category is undoubtedly the English gerund in *-ing*. In fact, the English gerund is a particularly complicated example, because there are three different phrasal configurations in which the gerund may appear, that is with entirely nominal, entirely verbal, or ‘mixed’ phrasal structure:

- (1) a. Type A: His stupid missing of the penalty lost us the game.
- b. Type B: Him stupidly missing the penalty lost us the game.
- c. Type C: His stupidly missing the penalty lost us the game.

I refer to these as English gerund types A, B and C respectively. In all these examples, the gerund heads a phrase which functions as subject of the sentence. In type A (1a), the syntax of the phrase headed by *missing* is entirely nominal: *missing* is premodified by an adjective and a possessor phrase, and the logical object of *missing* appears as a prepositional complement. The exclusively nominal syntax of the phrase means that *missing* here is unambiguously a noun, of category N, heading an unremarkable NP. The type A gerund type is therefore not a mixed category, and will not be considered further.

[†]I am very grateful for insightful comments and criticisms to Andrew Spencer, to the audience at SE-LFG 20, 21 May 2016, in particular Louisa Sadler, John Payne, Miriam Butt and Jamie Findlay, and to the audience at HeadLex16, 25 July 2016, in particular Bob Borsley and Dag Haug. This work was supported by a grant from the Jill Hart Fund for Indo-Iranian Philology at the University of Oxford, and parts of the work were undertaken while I was in receipt of an Early Career Research Fellowship from the Leverhulme Trust. All errors are of course my own.

In contrast, the syntax of the phrase headed by *missing* in type B (1b) is entirely verbal: the logical object appears in the same ‘bare’ form as an object of a finite verb (i.e. not embedded under a preposition); the logical subject likewise appears in the ‘bare’ form, with oblique/accusative case; and the modifier is an adverb. This type will be discussed below.

The unambiguously mixed construction is type C (1c): the logical object and the modifier are of the verbal type (as in (1b)), but the logical subject appears as a possessive phrase (as in (1a)). The analysis proposed by Bresnan et al. (2016, 311–319) involves a ‘head-sharing’ construction with a VP as (co-)head of a DP (the DP is the ‘extended head’ of VP); this is shown in (2).

The construction in (1c) involves a lexical category serving as (co-)head of a functional category (‘lexical-functional head-sharing’). It is also possible, however, for a lexical category to have a different lexical category as its extended head (‘lexical-lexical head-sharing’). Following Bresnan & Mugane (2006), Gĩkũyũ nominalizations involve a VP with NP as extended head (3).¹

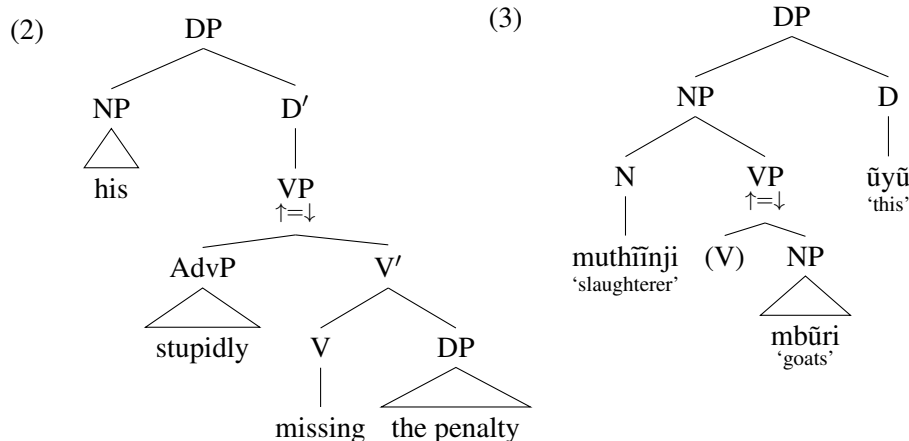

Other types of head-sharing construction have also been proposed, which do not correspond precisely to either of the types discussed above. For example, Nikitina (2008) proposes that IP may take DP as an extended head, i.e. that ‘functional-functional’ head sharing is possible, while Bresnan et al. (2016) allow the exocentric category S to take DP as extended head, and similarly Nikitina & Haug (2016) permit S to take NP as an extended head.

Bresnan (1997) contrasts the LFG approach to mixed categories with a number of alternative possibilities, most importantly ‘the indeterminate category projection theory’ and ‘projection-switching’ approaches. The ‘indeterminate’ approach assumes that the head of a mixed category is lexically underspecified for category, and projects a phrase which is likewise underspecified, such that it may contain e.g. both nominal and verbal structure. The ‘projection-switching’ approach is similar,

¹In the trees below I show only the crucial (co-)head annotation (↑=↓) which establishes the mixed category. Other annotations are as expected: heads are annotated ↑=↓, non-heads have other annotations.

only slightly more constrained, assuming that the head is assigned some kind of intermediate, or dual category, status, which enables it to project e.g. as a verb up to a certain level, and as a noun above.

Indeterminate or intermediate approaches to mixed categories have been widely proposed, in particular by Lapointe (1993), Hudson (2003), and Malouf (2000a) within HPSG. For example, Lapointe (1993) treats category labels as bipartite, and argues for an intermediate category (a “dual lexical category”) $\langle NIV \rangle$ to account for the English gerund. This category projects verbally, except for its top layer (ensuring it has the distribution of a noun phrase, for example), and the *-ing* suffix has a morphological function in deriving a category $\langle NIV \rangle$ from a plain category $\langle VIV \rangle$.

In the HPSG analysis by Malouf (2000a), the mixed properties of the English gerund are accounted for by means of the multiple inheritance hierarchy for HEAD values. The HEAD value *gerund* is a subtype of both *noun* and *verbal*. As a subtype of *noun*, its external distribution is that of an NP (it can “occur anywhere an NP is selected for”), and does not necessarily correspond to the distribution of verbs (which are a separate subtype of *verbal*). Adverbial modification applies to elements of category *verbal* (which includes *adjective*). Since adjectives modify only *c(ommon)-nouns*, gerund phrases cannot be modified by adjectives.

(4) English gerund in HPSG (Malouf, 2000b, 22)

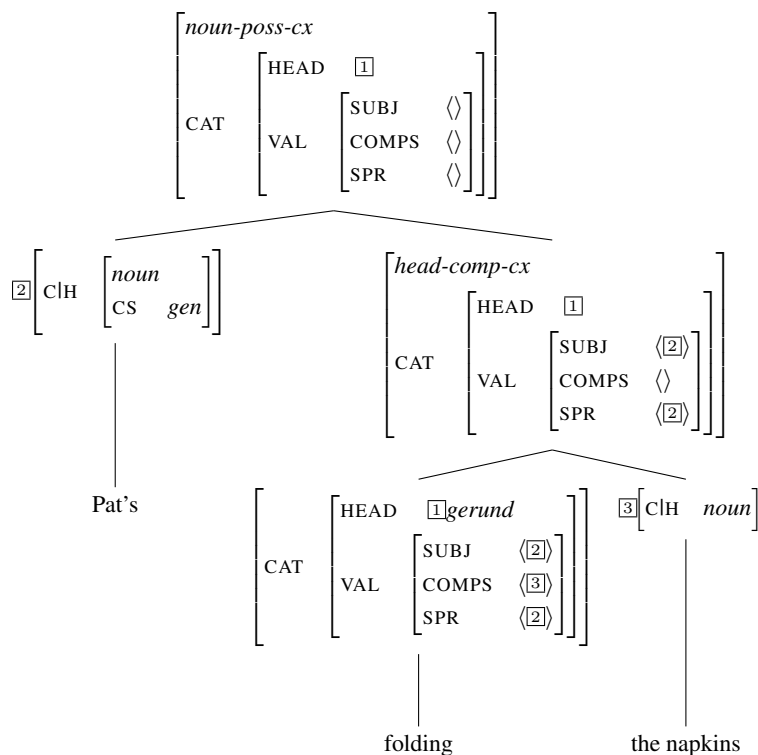

This is a more sophisticated intermediate category analysis, and the use of a multiple inheritance hierarchy permits cross-classification across more than one

grammatical category: it is possible to define a category that shares some features with nouns and some with verbs, without requiring it to be fully one or the other.

Within LFG, there is no concept of intermediate categories: there is a finite inventory of distinct lexical categories, and every lexical word must belong to exactly one category.² The different lexical categories are not unrelated; for example, Bresnan et al. (2016, 103) propose that the major lexical categories N, V, P and A can be analyzed according to a categorial feature matrix, whereby V and A are +PREDICATIVE and V and P are +TRANSITIVE, but these features are used purely to cross-classify pairs of categories, and not to license underspecified or intermediate categories. LFG also admits the possibility of complex categories (Butt et al., 1999, 192): within any one category it is possible to distinguish an unrestricted number of subcategories. However, categorization remains absolute, in the sense that every word is necessarily a member of one and only one syntactic (sub)category: it is not possible for a word or class of words to be intermediate between one category and another, or to be underspecified with respect to category membership.

The LFG approach to mixed categories violates a strict approach to endocentricity, both in the fact that words may head phrases of different categories (albeit restricted to cases of morphological derivation from the category concerned), and in the fact that lexical phrases are permitted to lack an explicit head internal to the phrase. This is not to say that the approach is therefore not viable, given that non- X' theoretic structures are admitted in LFG, but assuming that non-endocentric structures are a marked feature of grammar, it does suggest that mixed categories should be admitted only where an alternative, X' theoretic, analysis cannot adequately account for the linguistic data.

2 ‘Mismatched’ categories

Whatever approach one adopts to deal with mixed categories, it is clearly necessary to distinguish phrases that are mixed from those that are not. The English type C gerund (1c) is uncontroversially mixed: the phrase concerned contains both a nominal element, a possessor, and verbal elements, such an object and adverb. However, many authors also treat as mixed phrases which are consistently verbal in terms of their internal structure. Analyses of mixed categories proposed within LFG reveal three major properties implicated in the categorization of a word:

- (5) a. Internal syntax: the internal structure of the phrase, for example whether it contains determiners, adjectives, objects, adverbs.
- b. Distribution: the distribution of the phrase at a clausal level, for example whether it can appear in the same structural positions, and fill the

²Some words may belong to one lexical and one functional category, and/or more than one functional category.

same grammatical functions, as noun phrases that function as subjects and objects.

- c. Morphosyntax: the morphosyntactic properties of the head of the phrase, for example whether it shows the agreement features typical of a verb or an adjective.

Consider the type C gerund in (1c) and (2): the internal syntax of the phrase headed by the gerund is mixed, in that the phrase contains elements which are specific to DPs in English (possessive modifier) and elements which are specific to VPs in English (object and adverb modifier); the distribution of the phrase is nominal, since it can function as a subject (as in the example provided), object, or other grammatical function, or indeed can appear in any of the positions in a clause that an ordinary noun phrase can; given the lack of morphology in English, the gerund in *-ing* is morphologically unclear, but it shows the same kind of tense/aspect distinctions as finite verb sequences (cf. *his having missed the penalty...*), and so must be morphologically verbal on some level, at least.

In many discussions of mixed categories in LFG, mixed internal syntax is not considered necessary for the categorization of a phrase as mixed. So, Bresnan et al. (2016, 318) treat the type B English gerund (1b) via the same kind of head-sharing analysis as the type C construction (1c), the only difference being the category of the (co-)head phrase:

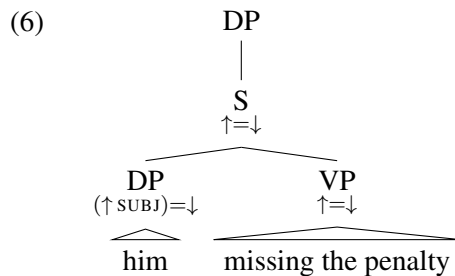

As with (2) above, the gerund appears in the head of a VP, with an object complement like any transitive V, but in this case the VP and accusative case subject phrase *him* together constitute a clausal phrase S, which serves as (co-)head of the higher DP. Thus the phrase as a whole is a DP, headed by a V in an embedded VP in an embedded S. This is very similar to (2). But the internal syntax of the phrase is entirely verbal (or clausal): there can be no adjectival modifier, or determiner or possessor phrase. Given that there are no explicit morphological properties of the gerund that require a DP node, it is clear that the DP node is assumed purely to account for the distribution of the phrase, i.e. distribution is taken as a sufficient criterion for mixed category status. Similarly, Haug & Nikitina (2016, 15) assume a head-sharing construction for a participle construction in Latin (the ‘dominant’ participle construction) which shows the external syntactic distribution of a noun, but whose internal syntactic structure is that of an S. Since Latin lacks a DP, they

assume an S as a (co-)head of a lexical category. Again, the only justification for the NP projection above S is the distribution of the phrase.

3 Attributive participles

The importance of both distribution and morphosyntax to categorization is evident in some LFG approaches to participles. Spencer (2015) discusses participles in Sanskrit, as treated by Lowe (2015), and also in Lithuanian, proposing an analysis that is in many respects the same as that proposed for German participles by Bresnan (1997, 2–3). All these participles are diachronically related, and are of the same ‘subject-oriented’ type; that is, to the extent that an attributive participial clause can be treated as a reduced relative clause, it is necessarily the subject that is relativized on. The participle agrees with and attributively modifies a noun, which is identified with the gapped subject of the participial clause. Ex. (7) shows an attributive participle in Sanskrit, (8) one from Lithuanian, and (9) one from German.

- (7) *sárasvatī sād^háyantī dhíyam naḥ*
 S.NOM.SG perfect.PTC.PRS.N.SG.F thought.ACC.SG us.GEN
 ‘Sarasvatī who perfects our thought’ (Sanskrit, RV 2.3.8a)

- (8) *ateisiančios žiemos ilgumo*
 come.PTC.FUT.ACT.GEN.SG.F winter.GEN.SG length
 ‘the length of the coming winter’ (Lithuanian, from Spencer, 2015, ex. 3)

- (9) *ein mehrere Sprachen sprechender Mann*
 a several language.PL speak.PTC.NOM.SG.M man.NOM.SG
 ‘A man who speaks several languages’ (German, cited by Bresnan, 1997, 2)

The attributive use is the most canonically adjectival use of participles, but adjectives can also, to a slightly more limited extent, be used as clausal adjuncts, so in both uses participles appear to display adjectival distribution. These participles can also have other uses. For example, as discussed by Lowe (2015), Sanskrit participles can also be used predicatively, that is in ‘converbal’ or clausal adjunct use (10).

- (10) *vīṣūco áśvān yuyujāná īyata ékaḥ*
 separated.ACC.PL horses.A yoke.PF.PTC.MED.NOM.SG.M speeds alone
 ‘Having yoked the separated horses, he speeds (off) alone.’ (RV 6.59.5cd)

I focus on attributive participles here, following Spencer (2015) and Bresnan (1997), but the analysis advanced could easily be extended to deal with predicative participles.

My concern in this paper is the phrasal structure of participle phrases, in particular their syntactic category, and not their functional representation. However,

Spencer (2015) draws a connection between the categorization and the f-structure representation, so it is necessary to briefly address the latter question. There are two proposals for the f-structural representation of attributive participle clauses in LFG. Lowe (2015, 87–94) proposes that attributive (‘adnominal’) participles be analysed as heading an ADJ in the f-structure, with a null subject anaphorically identified with the element which the participle modifies:

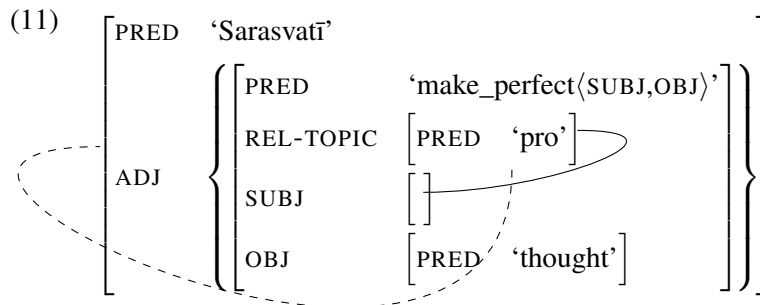

This analysis captures the similarity between attributive participial clauses and relative clauses, treating participles as essentially a reduced form of the latter, lacking an explicit relative pronoun. The alternative, assumed by e.g. Haug & Nikitina (2012, 2016) and Spencer (2015), is that the subject of the participle is not anaphorically but functionally controlled by the element the participle modifies, the participial phrase thus being an open adjunct XADJ at f-structure:

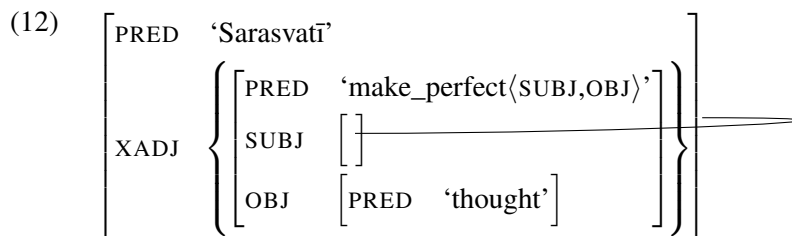

For participles of the Indo-European type considered here there is no evidence against the functional control analysis; it involves a simpler f-structure, and also means that both attributive and predicative uses of participles can be analysed in the same way at f-structure (since predicative participles are uncontroversially XADJs). On the other hand, the attributive XADJ analysis requires a cyclical f-structure, where the f-structure that serves as the SUBJ inside the f-structure of the participle is identical with the f-structure that contains the participle’s f-structure (and therefore also contains the SUBJ of the participle, i.e. itself). At a certain degree of cyclicity, cyclic f-structures are problematic: Wedekind (2014) shows that the universal generation problem for unification grammars can be undecidable for cyclic f-structures, whereas it is decidable for acyclic f-structures, as shown by Wedekind & Kaplan (2012). The degree of cyclicity required to render the universal general problem undecidable is considerably greater than in the simple case seen here, but

the very fact that cyclicity can cause problems for unification grammars suggests that it is perhaps better avoided.³

In any case, neither f-structure possibility is necessarily more adjectival or verbal than the other. The ADJ analysis is closer to the standard analysis of attributive adjectives in LFG as ADJ, but if adjectives were assumed to select for subjects, a far from unlikely possibility, then attributive adjectives would be XADJs, just like the participle in (12).⁴ Furthermore, neither f-structure analysis depends to any degree on the c-structure representation: either can be obtained without difficulty regardless of whether an A(dj) node is assumed in the projection of the participle phrase. The f-structure question is therefore tangential to the question of category.

Regarding the structure of participle phrases, Lowe (2015) takes internal syntax to be the primary criterion for category status. The internal syntax of participle phrases is exclusively verbal: e.g. participles of transitive verbal stems may take objects (7, 9), and participles may be modified by adverbs, but never by adjectives. Therefore Lowe (2015) proposes that participle phrases in Sanskrit are VPs headed by participle Vs. This is shown in (13), using English words for the Sanskrit of (7).

In contrast, Spencer (2015) makes a somewhat different proposal regarding the c-structure of attributive participles of the Sanskrit/Lithuanian/German type. Spencer's interest is in the interface between morphology and syntax, specifically how the apparently mixed morphological and mixed syntactic properties of participles can be linked. Building on Spencer (2013), a semantic argument structure representation in the morphology determines the category of a word. The morphological process which derives (or inflects) a participle from a verb creates a composite Semantic Function (SF) role, which projects to c- and f-structure in such a way that participles display both adjectival and verbal morphosyntax. In terms of syntactic category, Spencer (2015) proposes that the composite SF role maps to an intermediate category, which he labels 'V2A' (for 'verb-to-adjective transposition'); this is shown in (14).

(13) Ex. (7), flg. Lowe (2015):

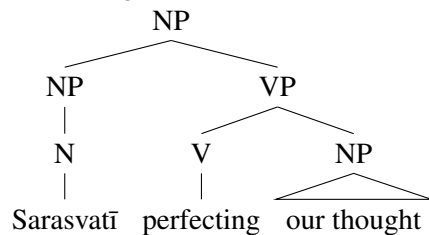

(14) Ex. (7), flg. Spencer (2015):

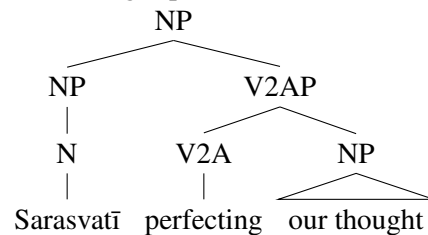

Spencer's intermediate category analysis is, as he notes, somewhat similar to other intermediate category proposals, such as that of Malouf (2000a). However, within LFG there is no concept of intermediate categories, meaning that the various features of the category must be stipulated. That is, it must be stipulated that V2A

³Thanks to Ron Kaplan (p.c.) for discussion of this point.

⁴On the selection of subjects by adjectives, see Dalrymple et al. (2004a, 197–198).

has the internal syntax of V and the distribution of Adj, since it does not fall out from any principle of intermediate category formation.⁵

This problem only arises for Spencer (2015), however, because he assumes that attributive participles are a mixed category, partly verbal and partly adjectival, and that there must therefore be an adjectival element to the participial phrase. But participles are not a mixed category in the same sense as the type C English gerund in (1c), since the internal syntax of participial phrases is exclusively verbal. Rather, participles are more like the type B English gerund or the Latin ‘dominant’ participle construction: it is only the distribution and the morphosyntactic properties of participles which suggest adjectival categorization.

4 Distribution

As discussed in detail in the preceding sections, distribution is taken as key evidence for the category of a phrase within LFG work on mixed categories. In the case of the type B English gerund (1b) and the Latin ‘dominant’ participle construction, distribution alone has been taken as sufficient evidence to justify a nominal projection, by Bresnan et al. (2016) and Haug & Nikitina (2016).

A detailed analysis of the category of the English gerund is undertaken by Seiss (2008). Seiss (2008) discusses a number of tests which have been proposed to show that English gerunds, including the type B gerund, have the distribution of nouns: functioning as subject or object, complementing prepositions, coordination with NPs, *it*-replacement, tough movement, topicalization, clefting, and pseudo-clefting (see e.g. Bresnan et al., 2016, 309–311). Seiss shows that all these tests also apply to some clausal phrase types, namely *that*-clauses and *to*-infinitive clauses; she argues that since all these distributional tests apply not only to nominal phrases but also to a subset of clausal phrase types, there is no reason to assume a nominal projection in the structure of the type B gerund. In place of Bresnan’s analysis of the English type B gerund as involving a DP dominating an S (6), Seiss (2008) proposes the following:

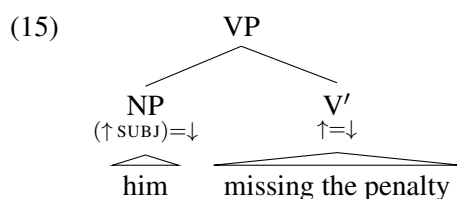

Under this analysis, the type B gerund is not a mixed category. The gerund itself is of category V, as in Bresnan et al.’s analysis, but it heads only a VP. The

⁵Spencer (2015) notes that an extended head approach would work for this type of participle, but he prefers the intermediate category analysis because the other requires the participle to be of category Adj, and in Spencer’s (2013) model, a participle of category Adj would necessarily be a different lexeme from the base verb (which would have category V).

only unusual features of this VP are the gerundal form of the verb, and the fact that the subject appears in SpecVP, not a standard position for subjects in English.

However, some of the tests discussed by Seiss (2008) are somewhat more ambiguous than they appear at first sight. While *that*-CPs and *to*-infinitives can appear in what looks like the same subject and object positions as ordinary DPs, Bresnan et al. (2016, 15–19) argue that these positions are subtly different. On the apparent appearance of CPs in subject position in English, Bresnan et al. (2016) note that auxiliary inversion is impossible with ‘subject’ *that*-CPs, while it is unproblematic with subject DPs:

- (16) a. *That/that he fell over* was quite unexpected.
b. Is *that/*that he fell over* unexpected?
c. How unexpected was *that/*that he fell over*.

On this basis, Bresnan et al. (2016) argue that ‘subject’ CPs do not appear in the standard structural position for subjects in English, SpecIP, but appear in a higher, adjoined, topic position, and can be identified as the subject by a default principle that subjects are topics. Bresnan et al. propose that SpecIP as the structural subject position in English can only be filled by noun phrases. The data for complement clauses in object position is more complicated, and is related to the ongoing uncertainty over the functional status of complement clauses in LFG. Bresnan et al. (2016, 18) note that complement clauses in English cannot generally enter into the passive alternation:

- (17) a. I don’t care that languages are learnable.
b. *That languages are learnable isn’t cared.

Bresnan et al. (2016, 18) argue that complement clauses are not objects, since only noun phrases can be objects, and this explains why they cannot be passivized. However, Alsina et al. (2005) argue that complement clauses may be OBJ, showing that some complement clauses in Catalan can become passive subjects. In fact some English verbs take clausal complements which may become passive subjects, including some *that*-CP complements:

- (18) a. We did not debate whether this was a good thing. / Whether this was a good thing was not debated.
b. They did not consider why he had come. / Why he had come was not considered.
c. They soon forgot that he had previously criticized them. / That he had previously criticized them was soon forgotten.

Clauses introduced by *wh*-words can relatively freely serve as passive subjects. In addition, subject *wh*-clauses can even undergo auxiliary inversion, suggesting that they can, in fact, appear in SpecIP, despite being clausal:

- (19) a. Whether he knows is not important.
b. Is whether he knows important?
c. How important is whether he knows?

The data for embedded clauses serving as subjects and objects is therefore relatively complicated, but it does not seem possible to restrict the canonical subject and object positions (and SUBJ and OBJ roles at f-structure) to noun phrases. In fact, other lexical categories may also appear in SpecIP:

- (20) a. Is slowly the best way to do it?
b. Is under the chair a good place to hide it?

Whether or not a particular embedded clause can serve as a subject or object depends partly on the matrix verb, and partly on the type of embedded clause concerned. Most importantly for the present topic, these restrictions do not seem to be enforceable by purely structural means, e.g. by restricting structural subject and core object positions in English to NP/DP. So distribution cannot be used as a *sufficient* criterion for a particular syntactic categorization.

It would alternatively be possible to consider distribution a *necessary* criterion for categorization: one could argue that two phrases must differ in distributional terms in at least one respect in order for them to be considered members of different categories, at least at the top level. That is, identity of distribution could be taken as evidence for identity of category. But it is not clear that embedded *wh*-clauses, in particular those introduced by *whether*, are any different from noun phrases in terms of their distribution in English. Given the difficulties discussed above in determining whether embedded clauses may occur in subject or object positions, two of the most easily identifiable positions, it seems reasonable to claim that if identity of distribution necessarily means identity of category, the burden of proof is on establishing absolute identity of category, rather than the other way around.

Consider also the relative benefits of treating distributional differences a necessary criterion for categorization. Given that identity of distribution may be accompanied by differences in internal syntax (as appears to be the case with the type B gerund and ordinary noun phrases), it would be necessary to admit mixed categories in such cases, e.g. where a phrase with the internal structure of a clause or VP could appear in all and only the positions that DPs could appear in. One could of course suppose that even *whether*-clauses and other embedded clause types are mixed, i.e. analysed as CP co-heads of DP. The obvious benefit of treating say the English type B gerund, or even a *whether*-clause, as a DP would be that it simplifies the phrase structure rules. For example, as assumed by Bresnan et al. (2016), one could argue that only DPs can appear in subject and object position in English, and it is neither necessary nor desirable to add an additional rule to the grammar licensing CP, S, or VP in those positions. However, such an apparent simplification of the grammar requires complication elsewhere. So, if only DP can appear

in subject and object position, but DPs can also serve as extended heads to clausal categories, some additional constraint will be required to ensure that only clauses of the correct type can serve as (co-)head in a DP. But such a constraint will be effectively equivalent, in terms of load on the grammar, to licensing clausal phrases of the appropriate type in subject and object position. For example, assume that English admits only DPs as the object complement of V:

$$(21) \quad V' \rightarrow V \quad DP \\ \uparrow=\downarrow \quad (\uparrow \text{OBJ}) =\downarrow$$

Now it becomes necessary to license type B gerunds as (co-)heads of DP, in order to account for sentences such as:

(22) I resented him giving my book away.

This can be achieved via the machinery for mixed categories discussed above. Embedding S under DP is not formalized by Bresnan et al. (2016), but it would require an additional stipulation, because it does not fall out from any of the principles discussed above. Alternatively, if we assume that the English type B gerund is a VP, its (co-)heading DP will be licensed by the principles discussed above, but we will require an additional rule to license the subject in SpecVP only in this construction. Either way, it will also be necessary to restrict the construction to cases where the V heading the phrase is a gerund, i.e. finite and infinitival Vs must be ruled out.

In contrast, this machinery can be considerably simplified by simply admitting S or VP as a possible object complement of V, when headed by a gerund. The restriction of the construction to a gerund is necessary under any analysis, and under this analysis can be easily achieved e.g. by a f-structure feature or a complex category. The following rule uses an f-structure feature VFORM to constrain the form of the verb via f-structure.

$$(23) \quad V' \rightarrow V \quad \{DP \quad | \quad S\} \\ \uparrow=\downarrow \quad (\uparrow \text{OBJ}) =\downarrow \quad (\uparrow \text{OBJ}) =\downarrow \\ (\downarrow \text{VFORM}) =_c \text{GER}$$

Thus it is by no means clear that a mixed analysis is any simpler than the alternative. Furthermore, given that mixed categories necessarily violate X' principles of endocentricity, it may be preferable to avoid an analysis involving a mixed construction whenever an equally empirically adequate alternative exists.

The distributional differences and similarities between participles and adjectives in languages like Sanskrit are similarly problematic. Attributive participle phrases do have the same distribution as attributive adjective phrases, in English as well as Sanskrit. But restrictive relative clauses also show the same distribution,

meaning that attributive modification does not necessarily involve an AdjP.⁶ At the same time, there may be differences in distribution between participle phrases and adjective phrases. In Ṛgvedic Sanskrit, for example, participles and adjectives share much of their distribution, both being able to function as attributive modifiers and as clausal adjuncts, but they differ fundamentally in that adjectives, but not participles, can freely occur as primary clausal predicates, with explicit or null copula (Lowe, 2015, 116–127). For example, it is not possible to form a sentence from the noun and participle phrase in (7) by making the latter the main predication, whereas this is unproblematic if the participle is replaced by a derived adjective with roughly the same meaning:

- (24) *sárasvatī sādhanāntī dhíyaṃ
 S.NOM.SG perfect.PTC.PRS.ACT.NOM.SG.F thought.ACC.SG
 naḥ
 us.GEN/DAT
 Intended meaning: ‘Sarasvatī (is the one who) perfects our thought.’

- (25) sárasvatī sādhanā dhíyo naḥ
 S.NOM.SG perfecting.NOM.SG.F thought.GEN.SG us.GEN/DAT
 ‘Sarasvatī (is the one who) perfects our thought.’

Thus it does not seem possible to use distribution as evidence for (even partial) categorial identity between adjectives and participles: participle phrases share much of their distribution and functionality with adjective phrases, but they are not identical, at least in English, Sanskrit and Lithuanian, and most likely in most or all languages with Indo-European type participles.

Given that participle phrases of the Indo-European type have the internal syntax of verb phrases, and that their distribution, while similar to adjectives, does not necessitate even partial adjectival categoriality, I propose that, just as assumed in Lowe (2015), participle phrases are VPs, headed by participial Vs, and do not involve any kind of category mixing. Of course, as with the English gerund discussed above, if participial phrases are VPs, then it is necessary to constrain their distribution, so that for example they can function as attributive modifiers and clausal adjuncts, but cannot function as primary clausal predicates. Once again, this is a trivial matter: for example a complex category V[ptc] (26), or reference to an f-structure feature VFORM PARTICIPLE (as in Lowe, 2015), can be used to effectively subdivide the category V in such a way that participle Vs can distribute differently from finite and other Vs. An advantage of assuming VP rather than an intermediate category like Spencer’s (2015) V2A, is that the exclusively verbal internal syntax of participle phrases falls out naturally if participle phrases are, in fact, VPs, whereas under an intermediate category analysis it must be stipulated.

⁶In English, attributive modification is restricted by the fact that right branching structures are prohibited in prenominal position, which rules out relative clauses, but not all adjectives and participle phrases, in prenominal position. But this constraint is purely to do with right branching, and not the category of the phrases involved.

(26) VP[ptc] → ... V'[ptc] ...
 (ADJ ∈ ↑)

However, Spencer's (2015) argument that participle phrases should be treated as at least partially categorially adjectival is not based on distribution alone, but also on the third criterion used for categorial status in LFG: morphosyntactic agreement features.

5 Morphology and agreement

At first sight, it might seem intuitively obvious that agreement and similar morphosyntactic properties provide evidence of categoriality. In most languages with rich morphological systems, some features are typically expressed on verbs, and others on nouns and adjectives. Many Indo-European languages, including those discussed in the previous section, typically mark person and number on verbs, and case, number and gender on nouns and adjectives: thus person is a feature of verbal morphosyntax, and case and gender features of nominal and adjectival morphosyntax. However, even cross-linguistically regular tendencies may have exceptions; for example, Nordlinger & Sadler (2004a,b) discuss languages in which tense features can be marked on nominals. Within languages too, there are often exceptions to the typical division of morphosyntactic labour between nouns and verbs.

In particular, it is not uncommon for unequivocal finite verb categories to show 'adjectival' or 'nominal' agreement in some languages, in cases where non-finite verbal categories such as participles or agent nominalizations have become grammaticalized and integrated into the finite verbal paradigm. For example, finite present and future verb forms in Russian (and other Slavic languages) mark person and number, but past tense verbs, marked with the formant *-l-*, agree rather in gender and number. The gender/number morphology of past tense verbs in Russian is essentially identical to that of nouns and adjectives in Russian. Diachronically, the past tense in *-l-* derives from a construction involving a verbal adjective in **-lo-*; at some point in the pre-history of Slavic, the forms in *-l-* were categorial adjectives, but now there is no justification for analysing the past tense formation in *-l-* as anything other than fully verbal. Many languages attest equivalent developments; e.g. in many Indo-Aryan languages the (often ergative) perfective aspect derives from what is in Sanskrit a verbal adjective.

So diachronic developments may lead to the recategorization of a particular formation, without necessitating any corresponding morphosyntactic reformation. Thus from a diachronic perspective, it is problematic to assume that morphosyntax necessarily tells us anything about the synchronic status of a formation. If a verb form happens to show adjectival agreement, this does not mean it is synchronically an adjective.

On a purely synchronic level, however, Spencer (2015) argues that it should not be an accident that participles show exactly the same agreement features, and even paradigms, as lexical adjectives. For example, on Lowe's (2015) analysis

of Sanskrit participles as Vs, there is no account of the fact that participles and adjectives show the same morphosyntactic properties: it appears to be a synchronic accident. If a synchronic account can be given which could account for the shared morphological properties of adjectives and participles, all the better.

Any such account must be fundamentally morphological. Spencer's (2015) argument that participles are categorially adjectival (at least in part) due to their adjectival morphosyntax depends on the assumption that the morphological feature(s) shared between adjectives and participles necessarily influence the syntactic category of a word. In Spencer's model this is true, since it is the adjectival semantic function in the argument structure representation of a lexeme which determines both agreement properties and syntactic category.

In a different morphological model, however, there need not be a one-to-one correspondence between morphological category and syntactic category. Dalrymple (2015) proposes a model for the morphology-syntax interface as a way of representing the contribution of morphology to the syntactic properties of words. The model presupposes a realizational theory of morphology, which Spencer (2013, 2015) likewise assumes.

Dalrymple (2015) proposes that lexical entries, the building blocks of syntax, are constructed on the basis of three sub-syntactic components: lexemic entries *LE*, the realization relation *R*, and the functional description function *D*. A lexemic entry is a pairing between a lexeme and grammatical information common to all word forms of that lexeme. Formally, *LE* is a three-place relation defining: a. the form(s) of the root; b. f-descriptions common to all forms of the lexeme; and c. the Lexemic Index (LI), a unique identifier of the lexeme. For example, the *LE* for the Sanskrit lexeme underlying the adjective *ugra*- 'fierce' is:

(27) *LE* <{ROOT: *ugra*}, {(↑ PRED)='fierce'}, FIERCE1>

The first part of the relation defines the form of the root; there are no suppletive or irregular forms, so only the single form appears. The second part of the relation defines syntactic information common to all forms of the lexeme; here, only the f-structure PRED value is represented. This information is represented as part of the lexemic entry itself, since it cannot be changed by morphological processes. The third part of the relation is the LI, which is simply a unique label identifying this lexeme, which could be used, for example, to constrain the application of a particular morphological rule if it were specific to this lexeme.

The realization relation *R* is a set of four-place relations, *m-entries*, which associate a LI, an s-form, and a p-form with a set of m(orphological)-features.⁷ Ex. (28) shows the m-entry for the word form *ugrah*, nominative singular masculine of the lexeme FIERCE1. The first part of the relation specifies the lexeme by its LI: this m-entry applies only to this particular lexeme (other lexemes will have equivalent m-entries). The second two parts of the relation define the s-form and p-form for

⁷On p-forms and s-forms, see Dalrymple & Mycock (2011) and Mycock & Lowe (2013).

the word. The fourth part of the relation specifies certain m-features which are associated with this morphological form of the lexeme.

(28) $R \langle \text{FIERCE1}, \text{ugrah}, /ugrah/, \{ \text{M-CAT:ADJ}, \text{M-CASE:NOM}, \text{M-NUM:SG}, \text{M-GEND:MASC} \} \rangle$

The set of m-features specified in (28) can be understood as the set of m-features associated with the adjectival suffix in a given case/number/gender combination. Abstracting over sets of m-features using templates (Dalrymple et al., 2004b), we can rewrite (28) as in (29), where the template is defined as in (30)

(29) $R \langle \text{FIERCE1}, \text{ugrah}, /ugrah/, \{ @\text{M-ADJ}(\text{NOM,SG,MASC}) \} \rangle$

(30) $\text{M-ADJ}(_ \text{CASE}, _ \text{NUM}, _ \text{GEND}) \equiv \text{M-CAT:ADJ}, \text{M-CASE:} _ \text{CASE}, \text{M-NUM:} _ \text{NUM}, \text{M-GEND:} _ \text{GEND}$

The use of a template simply permits us to generalize over the morphological contribution of adjectival formants. Thus $\text{M-ADJ}(_ \text{CASE}, _ \text{NUM}, _ \text{GEND})$ represents morphological ‘adjective-hood’ (including the specification M-CAT:ADJ), and is instantiated to different case/number/gender combinations in particular instances by means of the argument variables.

The description function D maps a set of m-features to the relevant c-structure category and f-descriptions, given a particular LI. That is, D converts m-features introduced by the m-entry of a particular word form into syntactic features. So, in (31), the lexeme labelled FIERCE1 and the m-features M-CAT:ADJ , M-CASE:NOM , M-NUM:SG , M-GEND:MASC are associated with the syntactic category Adj and the f-structure features $(\uparrow \text{CASE}) = \text{NOM}$, $(\uparrow \text{NUM}) = \text{SG}$, and $(\uparrow \text{GEND}) = \text{MASC}$.

(31) Description function D for *ugrah*:
 $D \langle \text{FIERCE1}, \{ \text{M-CAT:ADJ}, \text{M-CASE:NOM}, \text{M-NUM:SG}, \text{M-GEND:MASC} \}, \text{Adj}, \{ (\uparrow \text{CASE}) = \text{NOM}, (\uparrow \text{NUM}) = \text{SG}, (\uparrow \text{GEND}) = \text{MASC} \} \rangle$

For the present purposes, the description function D is of central importance, as it relates morphological features to syntactic features, including syntactic category. D is a composite function, elements of which can be specified separately; in particular Dalrymple (2015) defines the description function D_{cat} which specifies the c-structure category alone, based on the LI and m-features.

Turning now to participles, the lexemic entry for the Sanskrit verbal root *gam* ‘go’ will be as in (32); the m-entry for the nom. pl. masc. present participle *gacchantah* ‘going’ will be as in (33).

(32) $LE \langle \{ \text{ROOT: gam; STEM1: gaccha} \}, \{ (\uparrow \text{PRED}) = \text{‘go’} \}, \text{GO1} \rangle$

(33) $R \langle \text{GO1}, \text{gacchantah}, /gátʃantah/, \{ \text{M-TENSE:PRES}, \text{M-VOICE:ACT}, @\text{M-ADJ}(\text{NOM,PL,MASC}) \} \rangle$

For our purposes the important point is that both lexical adjectives and participles, which are forms of verbal lexemes, make use of the template M-ADJ and thus share the same adjectival m-features. Thus morphological ‘adjective-hood’ has a unified and coherent morphological contribution in the lexicon, addressing Spencer’s (2015) concern.

In order to produce a lexical entry for both *ugrah* and *gacchantah*, we require description functions, which map the set of m-features to the appropriate c-structure category and f-description. The present concern is the c-structure category. Dalrymple (2015) proposes the following basic structure for D_{cat} :

- (34) $D_{cat} \langle LI, m\text{-features}, N \rangle$ iff M-CAT:N \in m-features.
 $D_{cat} \langle LI, m\text{-features}, V \rangle$ iff M-CAT:V \in m-features.
 $D_{cat} \langle LI, m\text{-features}, Adj \rangle$ iff M-CAT:ADJ \in m-features. etc.

These functions relate lexical indices and sets of m-features with a particular syntactic category, and the function is constrained to apply if and only if a particular m-feature appears in the set of m-features associated with the word form (i.e. specified in the word form’s m-entry). So, in the case of *ugrah*, we can assume that the third line of (34) will apply: M-CAT:ADJ appears in the m-features for *ugrah*, so it will map to the syntactic category Adj.

These examples represent the expected mappings, and are likely to be the defaults cross-linguistically. However, the ability to specify these mapping by the lexemic index LI means that in principle the mappings between M:CAT features and grammatical category need not be uniform, even within a single language. So we can assume that the following applies for all lexical adjectives in Sanskrit, including *ugra-* (FIERCE1):

- (35) $D_{cat} \langle LI_{adj}, m\text{-features}, Adj \rangle$ iff M-CAT:ADJ \in m-features.

where LI_{adj} is the set of lexemic indices associated with lexemic entries which are fundamentally adjectival, i.e. {HAPPY1, SAD1, TALL1, FIERCE1... }.

However, it is equally possible to assume that in the case of morphological adjectives based on verbal lexemes, there is a different specification:

- (36) $D_{cat} \langle LI_{vb}, m\text{-features}, V[ptc] \rangle$ iff M-CAT:ADJ \in m-features.

where LI_{vb} is the set of LIs associated with a verbal lexeme, i.e. {GO1, FIND1, LOVE1... }. Crucially, the specification in (36) associates the m-feature M-CAT:ADJ with the syntactic category V, for a certain set of lexemes in the language. Thus, although the morphological adjective-hood of a participle supplies the same m-features as for any lexemic adjective, the one specifying grammatical category is treated differently due to the verbal nature of the base lexeme, resulting in a mapping from M-CAT:ADJ to the grammatical category V in the case of participles.

Thus the model for representing the morphology-syntax interface proposed by Dalrymple (2015), which presupposes a realizational theory of morphology just

as Spencer (2015) does, permits both a unified, coherent morphological representation of adjective-hood, which can include not only lexical adjectives but also participles, and permits participles, as instantiations of verbal lexemes, to map to the category V, while lexical adjectives map to the category Adj.

Thus both conceptually and formally, there is no support for using morphosyntactic features such as agreement properties as evidence for categorial status. This means that of the three criteria used in discussions of mixed categories in LFG, two do not necessarily reveal anything about the syntactic category of a word. We are left with internal syntax as the only remaining criterion for distinguishing syntactic categories. On some level, this seems intuitively reasonable. Granted that English DPs and CPs are not necessarily distinguished by distribution, as discussed above, and given that English is relatively lacking in morphology, why do we have no problem in identifying a particular phrase as a DP rather than a CP, or vice versa? The obvious difference between them is their internal syntax: one has one type of internal syntax, including the possibility of adjectival modification and determiners, while the other has a different type of internal syntax, including complementizers, subject positions, and verb phrases.

Whether an approach to syntactic categories based purely on internal syntax is viable is a larger topic that cannot be fully addressed here. But the evidence of mixed categories, at least, seems to bear it out. I conclude therefore that mixed categories are necessary only when the internal syntax of a phrase is mixed, as in the case of the English type C gerund, but that a mixed category analysis is not necessary when the internal structure of a phrase is uniformly of one category, where we are dealing merely with a mismatch between internal syntax and distribution and/or morphosyntax.

6 Conclusion

I have shown that recent work on mixed categories in LFG depends on three main criteria for category membership: internal syntax, distribution, and morphosyntax. I have also shown that two distinct phenomena have received mixed category analyses within LFG. Truly mixed phrases are those where the internal syntax of the phrase is itself mixed. A number of mixed category proposals have been made, however, for phenomena where there is no evidence for mixed internal syntax, but where there is merely a mismatch between the internal syntax and the distribution and/or morphosyntax of the phrase. I have shown that distribution and morphosyntax are not reliable as evidence for categoriality, and thus argue that such ‘mismatched’ categories (e.g. participles) should not be analysed as mixed categories.

References

Alsharif, Ahmad. 2014. *The syntax of negation in Arabic*: University of Essex dissertation.

- Alsina, Alex, K. P. Mohanan & Tara Mohanan. 2005. How to get rid of the COMP. In Miriam Butt & Tracy Holloway King (eds.), *Proceedings of the LFG05 Conference*, Stanford, CA: CSLI Publications.
- Börjars, Kersti, Safiah Madkhali & John Payne. 2015. Masdars and mixed category constructions. In Miriam Butt & Tracy Holloway King (eds.), *Proceedings of the LFG15 Conference*, 26–42. Stanford, CA: CSLI Publications.
- Bresnan, Joan. 1997. Mixed categories as head sharing constructions. In Miriam Butt & Tracy Holloway King (eds.), *Proceedings of the LFG97 Conference*, Stanford, CA: CSLI Publications.
- Bresnan, Joan. 2001. *Lexical-functional syntax*. Oxford: Blackwell.
- Bresnan, Joan, Ash Asudeh, Ida Toivonen & Stephen Wechsler. 2016. *Lexical-functional syntax*. Oxford: Wiley-Blackwell. Second edition. First edition by Joan Bresnan, 2001, Blackwell.
- Bresnan, Joan & John Mugane. 2006. Agentive nominalizations in Gĩkũyũ and the theory of mixed categories. In Miriam Butt, Mary Dalrymple & Tracy Holloway King (eds.), *Intelligent linguistic architectures: Variations on themes by Ronald M. Kaplan*, 201–234. Stanford, CA: CSLI Publications.
- Butt, Miriam, Tracy Holloway King, María-Eugenia Niño & Frédérique Segond. 1999. *A grammar writer's cookbook*. Stanford, CA: CSLI Publications.
- Dalrymple, Mary. 2015. Morphology in the LFG architecture. In Miriam Butt & Tracy Holloway King (eds.), *Proceedings of the LFG15 Conference*, 43–62. Stanford, CA: CSLI Publications.
- Dalrymple, Mary, Helge Dyvik & Tracy Holloway King. 2004a. Copular complements: Closed or open? In Miriam Butt & Tracy Holloway King (eds.), *Proceedings of the LFG04 Conference*, 188–198. Stanford, CA: CSLI Publications.
- Dalrymple, Mary, Ronald M. Kaplan & Tracy Holloway King. 2004b. Linguistic Generalizations over Descriptions. In Miriam Butt & Tracy Holloway King (eds.), *Proceedings of the LFG04 Conference*, 199–208. Stanford, CA: CSLI Publications.
- Dalrymple, Mary & Louise Mycock. 2011. The prosody-semantics interface. In Miriam Butt & Tracy Holloway King (eds.), *Proceedings of the LFG11 Conference*, 173–193. Stanford, CA: CSLI Publications.
- Haug, Dag T. T. & Tanya Nikitina. 2012. The many cases of non-finite subjects: The challenge of “dominant” participles. In Miriam Butt & Tracy Holloway King (eds.), *Proceedings of the LFG12 Conference*, 292–311. Stanford, CA: CSLI Publications.
- Haug, Dag T. T. & Tanya Nikitina. 2016. Feature sharing in agreement. *Natural Language & Linguistic Theory* 34. 865–910.
- Hudson, Richard A. 2003. Gerunds without phrase structure. *Natural Language & Linguistic Theory* 21. 579–615.

- Lapointe, Steven G. 1993. Dual lexical categories and the syntax of mixed category phrases. In A. Kathol & M. Bernstein (eds.), *Proceedings of the Eastern States Conference on Linguistics*, 199–210. Ithaca, NY: Cornell University.
- Lowe, John J. 2015. *Participles in Rigvedic Sanskrit: The syntax and semantics of adjectival verb forms*. Oxford: Oxford University Press.
- Malouf, Robert. 2000a. *Mixed categories in the hierarchical lexicon*. Stanford, CA: CSLI Publications.
- Malouf, Robert. 2000b. Verbal gerunds as mixed categories in HPSG. In R. Borsley (ed.), *The nature and function of syntactic categories*, 133–166. New York: Academic Press.
- Mycock, Louise & John J. Lowe. 2013. The prosodic marking of discourse functions. In Miriam Butt & Tracy Holloway King (eds.), *Proceedings of the LFG13 conference*, 440–460. Stanford, CA: CSLI Publications.
- Nikitina, Tatiana V. 2008. *The mixing of syntactic properties and language change*: Stanford University dissertation.
- Nikitina, Tatiana V. & Dag T. T. Haug. 2016. Syntactic nominalization in Latin: a case of non-canonical subject agreement. *Transactions of the Philological Society* 114(1). 25–50.
- Nordlinger, Rachel & Louisa Sadler. 2004a. Tense beyond the verb: Encoding clausal tense/aspect/mood on nominal dependents. *Natural Language & Linguistic Theory* 22(3). 597–641.
- Nordlinger, Rachel & Louisa Sadler. 2004b. Nominal tense in crosslinguistic perspective. *Language* 80(4). 776–806.
- Seiss, Melanie. 2008. The English *-ing* form. In Miriam Butt & Tracy Holloway King (eds.), *Proceedings of the LFG08 Conference*, 454–472. Stanford, CA: CSLI Publications.
- Spencer, Andrew. 2004. Towards a typology of mixed categories. In C. Orhan Orgun & Peter Sells (eds.), *Morphology and the web of grammar: Essays in memory of Steven G. Lapointe*, Stanford, CA: CSLI Publications.
- Spencer, Andrew. 2013. *Lexical relatedness: A paradigm-based approach*. Oxford: Oxford University Press.
- Spencer, Andrew. 2015. Participial relatives in LFG. In Miriam Butt & Tracy Holloway King (eds.), *Proceedings of the LFG15 Conference*, 378–398. Stanford, CA: CSLI Publications.
- Wedekind, Jürgen. 2014. On the universal generation problem for unification grammars. *Computational Linguistics* 40(3). 533–538.
- Wedekind, Jürgen & Ronald M. Kaplan. 2012. LFG generation by grammar specialization. *Computational Linguistics* 38(4). 867–915.